

YAMAHA
FM VOICE EXPANDER / AWM VOICE EXPANDER

FVX-1 / AVX-1

USER'S GUIDE

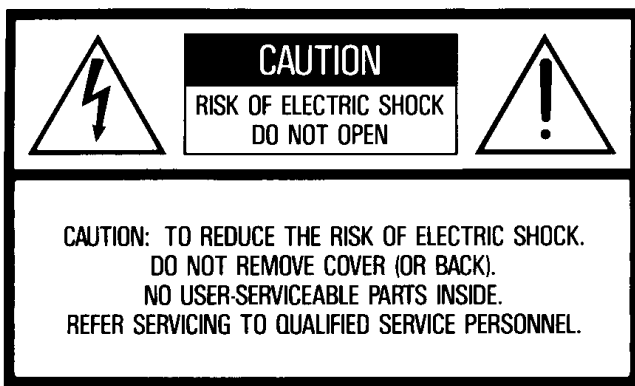

Explanation of Graphical Symbols

The lightning flash with arrowhead symbol, within an equilateral triangle, is intended to alert the user to the presence of uninsulated "dangerous voltage" within the product's enclosure that may be of sufficient magnitude to constitute a risk of electric shock to persons.

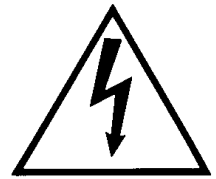

The exclamation point within an equilateral triangle is intended to alert the user to the presence of important operating and maintenance (servicing) instructions in the literature accompanying the product.



IMPORTANT SAFETY AND INSTALLATION INSTRUCTIONS

INFORMATION RELATING TO POSSIBLE PERSONAL INJURY, ELECTRIC SHOCK, AND FIRE HAZARD POSSIBILITIES HAS BEEN INCLUDED IN THIS LIST.

WARNING—When using electronic products, basic precautions should always be followed, including the following:

1. Read all Safety and Installation Instructions, Supplemental Marking and Special Message Section data, and assembly instructions (where applicable) BEFORE using your Yamaha electronic product. Check unit weight specifications before you attempt to move this instrument!

2. Main Power Supply Verification: Your Yamaha electronic product has been manufactured specifically for the main supply voltage used in your area. If you should move, or if any doubt exists, please contact your dealer for instructions. The main supply voltage required by your electronic product is printed on the name plate. For name plate location, see graphic in Special Message Section.

3. This product may be equipped with a polarized line plug (one blade wider than the other). If you are unable to insert the plug into the outlet, contact an electrician to have your obsolete outlet replaced. Do NOT defeat the safety purpose of the plug. Yamaha products not having polarized plugs incorporate construction methods and designs that do not require line plug polarization.

4. **WARNING**—Do NOT place objects on your electronic product's power cord or place the unit in a position where anyone could trip over, walk over, or roll anything over cords of any kind. Do NOT allow your electronic product or its bench to rest on or be installed over cords of any type. Improper installations of this type create the possibility of a fire hazard and/or personal injury.

5. Environment: Your electronic product should be installed away from heat sources such as a radiator, heat registers and/or other products that produce heat. Additionally, the unit should not be located in a position that exposes the cabinet to direct sunlight, or air currents having high humidity or heat levels.

6. Your Yamaha electronic product should be placed so that its location or position does not interfere with its proper ventilation.

7. Some Yamaha electronic products may have benches that are either a part of the product or supplied as an optional accessory. Some of these benches are designed to be dealer assembled. Please make sure that the bench is stable before using it. The bench supplied by Yamaha was designed for seating only. No other uses are recommended.

8. Some Yamaha electronic products can be made to operate with or without the side panels or other components that constitute a stand. These products should be used only with the components supplied or a cart or stand that is recommended by the manufacturer.

9. Do not operate for a long period of time at a high volume level or at a level that is uncomfortable. If you experience any hearing loss or ringing in the ears, you should consult an audiologist.

10. Do not use your Yamaha electronic product near water or in wet environments. For example, near a swimming pool, spa, or in a wet basement.

11. Care should be taken so that objects do not fall, and liquids are not spilled, into the enclosure through openings.

12. Your Yamaha electronic product should be serviced by a qualified service person when:

- a. The power-supply cord or plug has been damaged: or
- b. Objects have fallen, or liquid has been spilled into the product: or
- c. The product has been exposed to rain: or
- d. The product does not operate, exhibits a marked change in performance: or
- e. The product has been dropped, or the enclosure of the product has been damaged.

13. When not in use, always turn your Yamaha electronic product "OFF". The power-supply cord of the product should be unplugged from the outlet when it is to be left unused for a long period of time. Notes: In this case, some units may lose some user programmed data. Factory programmed memories will not be affected.

14. Do not attempt to service the product beyond that described in the user-maintenance instructions. All other servicing should be referred to qualified service personnel.

15. Electromagnetic Interference (RFI). This series of Yamaha electronic products utilizes digital (high frequency pulse) technology that may adversely affect Radio/TV reception or the operation of other devices that utilize digital technology. Please read FCC Information (Page 61) for additional information.

**PLEASE KEEP THIS MANUAL
FOR FUTURE REFERENCE!**

Thank you for purchasing a Yamaha Voice Expander FVX-1/AVX-1.

Developed as one of the components that comprise the expanded system of the HX Series Electone, the FVX-1/AVX-1 is a MIDI-compatible Voice Expander equipped with a large number of outstanding features.

To be sure you get maximum satisfaction and use the FVX-1/AVX-1 under optimum conditions, please read through this User's Guide carefully.

- | | |
|---------------------------------------------------------------------------------------------------------------------------------------------------------------------------------------------------------------------------------------------------------|----------------------------------------------------------------------------------------------------------------------------------------------------------------------------------------------------------------------------------------------------------------------------------------------------------------------------------------------------------|
| <ul style="list-style-type: none">● Before reading this Guide, be sure to read the "HX-SERIES EXPANDED SYSTEM USER'S GUIDE."● To avoid unexpected accidents, be sure to read "Handling Precautions" and "Connection Procedures." | <ul style="list-style-type: none">● The contents of this Guide is subject to change without advance notice.● While every precaution has been taken to ensure the accuracy of this Guide, please contact the Yamaha Music Dealer where you purchased this unit in the case you have any questions or detect any error or omission. |
|---------------------------------------------------------------------------------------------------------------------------------------------------------------------------------------------------------------------------------------------------------|----------------------------------------------------------------------------------------------------------------------------------------------------------------------------------------------------------------------------------------------------------------------------------------------------------------------------------------------------------|

Contents

I. INTRODUCTION	Page
1. Handling Precautions	2
2. Connection Procedures	3
3. Description of the Parts (Front Panel)	5
4. An Overview of the Functions	6
5. Installing the AWM Voice Pack [AVX-1]	8
6. The Power-On Status and Reset	9
7. Volume Level Control	10
8. Now, Let's Produce Some Sounds	11
II. MIDI-RELATED SETTINGS	
1. MIDI ENABLE (Choosing the Tone Groups to be Sounded)	12
2. MIDI (Setting the Receiving Channels)	13
III. SETTING A REGISTRATION	
1. VOICE (Choosing the Voices)	14
2. LEVEL (Setting the Volume Level)	15
3. SUSTAIN (Setting the Sustain Length)	16
4-a. EFF. SEL. (Selecting the Effector)	17
4-b. EFF. DEP. (Setting the Effector Parameters)	18
5. VIBRATO (Setting the Vibrato Parameters) [FVX-1]	19
6. OCT. SHIFT (Setting the Octave Shift) [AVX-1]	20
7. FUNCTION (Setting the Functions)	21
IV. REGISTRATION MEMORY	
1. MEMORY (The Registration Memory)	38
2. REGIST. (Recalling or Editing a Registration)	40
V. THE PACK FUNCTIONS	
1. Reading and Writing the Registration Data	42
2. Reading and Writing User Voice Data [FVX-1]	43
VI. OTHER INFORMATION	
● The Preset Voices [FVX-1]	44
● The Algorithm Patterns [FVX-1]	48
● The Default Settings	49
● The Effector Parameters	50
● The Functions	51
● The MIDI Codes	52
● MIDI Implementation Charts	53
● The Status Codes	55
● Specifications	55
● Blank Copy of Registration Chart [FVX-1]	56
● Blank Copy of Registration Chart [AVX-1]	58
● Blank Copy of Voice Editing Chart [FVX-1]	60
● FCC INFORMATION (USA)	61

I-1 Handling Precautions

*Be sure to also read the section on "Handling Precautions" in the separate "HX-SERIES EXPANDED SYSTEM USER'S GUIDE."

Power Supply

- Make sure to use the supply voltage that is listed on the nameplate at the bottom of this unit.
- In case of electrical storm probability, unplug the power cord from the electrical socket in advance.
- If you will not use the product for a long period of time, unplug its power cord from the socket.
- Please note that the sound quality may be adversely affected when the product is used on the same circuit with another device or appliance of large power consumption, or with numerous devices on an adapter plug.

Power Cord

- Be careful not to touch the power plug with wet hands; you may receive an electric shock.
- To prevent damage and short-circuiting of the cord wires, always hold the power plug when unplugging the cord and never pull on the cord.
- Do not place objects or step on the power cord.
- It is dangerous to extend the power cord yourself.

Connection

- Before connecting this unit, make sure that the POWER switch of all devices to be connected is turned OFF.
- Properly connect this unit while referring to "Connection Procedures" in this Guide as well as "Connection Procedures" in the separate "HX-SERIES EXPANDED SYSTEM USER'S GUIDE."
- Avoid binding the MIDI cables together with the power cords.

Remodeling and Parts Replacement

- Do not remodel any of the components nor replace their parts yourself. Such actions can cause serious damage to the entire system.
- Any repair work, such as the replacement of parts or the backup battery, must be done by qualified service personnel.

Handling and Transport

- Never subject the buttons, knobs, and switches to unnecessary force.
- To prevent damage and short-circuiting of the cord wires, always hold the plug when unplugging the cord and never pull on the cord.
- To prevent damage and short-circuiting of the cord wires during transport of this unit, make sure to disconnect the power cord and all other cords before transport.
- Do not place objects on top of this unit nor block the ventilation openings.
- Be careful to avoid dropping metals object, paper, or other foreign matter into the openings.
- If water accidentally enters the unit's interior, immediately turn OFF the POWER switch, unplug the power cord, and contact the Yamaha Music Dealer where you purchased this unit.

Choosing an Installation Site

- Avoid places exposed to direct sunlight.
- Never place the unit near sources of heat, such as a heater.
- Avoid places exposed to excessive moisture, dust, and excessively low temperatures.
- Install the unit on a flat surface that is not subject to vibration.
- If possible, it is best to install the unit using the dedicated rack RAX-1/RAX-1 (S).
- Avoid places where chemicals are used or where the unit is likely to be exposed to chemicals.

Cleaning the Outer Case

- Clean the outer case by wiping it with a soft, dry cloth.
- Never use thinner, benzene, or chemically harsh solvents nor chemically-treated cloths.
- If the case is particularly dirty, moisten a soft, clean cloth in a mild detergent diluted with water, wring the cloth out well, then wipe off the soiled areas. Next, wipe the unit again with a dry cloth.

Electromagnetic Interference

- This unit utilizes digital (high-frequency pulse) technology that may adversely affect the reception of radio, TV, or other electrical equipment used at the same time. Be sure to provide adequate distance between this unit and the device that is being affected by the interference.
- If a high-power broadcasting station or amateur wireless station is nearby, its radio waves may affect this unit.

If the Unit Operates Abnormally

- If this unit produces smoke or an abnormal odor, immediately unplug the power cord and contact the Yamaha Music Dealer where you purchased this unit.
- Even if you think that the unit has simply blown a fuse, contact your the Yamaha Music Dealer where you purchased this unit.

*Also read "Connection Procedures" in the "HX-SERIES EXPANDED SYSTEM USER'S GUIDE."

■ IN/OUT Jacks

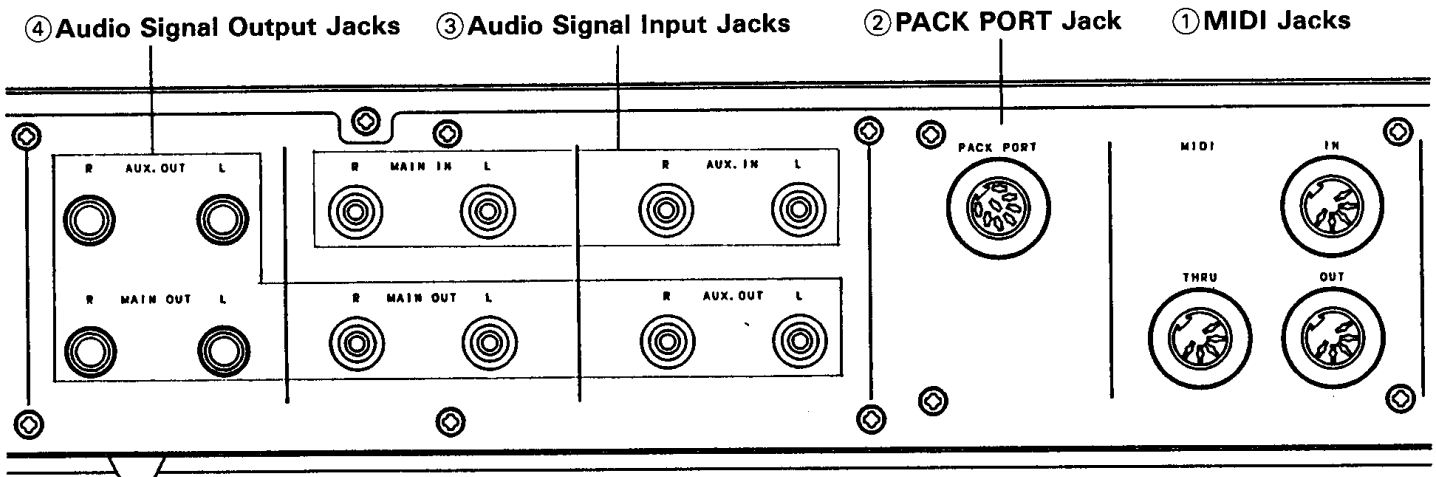

① MIDI Jacks	MIDI IN	This jack is used to receive MIDI signals, and is connected to the MIDI OUT jack of another device, such as MDX-1 or HX. (The front panel's MIDI OUT jack is reserved for connecting a remote keyboard, etc.)
	MIDI OUT	This jack is used to send MIDI signals (Bulk data only) to a device that is connected via its MIDI IN jack. This jack is connected to the MIDI OUT jack of MDX-1, etc. (The front panel's MIDI OUT jack sends Bulk data exclusively to the device connected to the front panel's MIDI IN jack.)
	MIDI THRU	This jack directly transfers the signal received at the MIDI IN jack. It is used in a system that does not include MDX-1 when you wish to simultaneously send MIDI signals from one instrument to multiple Voice Expanders.
② PACK PORT Jack	PACK PORT	This jack is used to send and receive Bulk data, and is connected to Memory Bank MBS-10. (For details, refer to the "MBS-10 USER'S GUIDE.")
③ Audio Signal Input Jacks	MAIN IN (L/R)	These input jacks are used, for example, in the case multiple Voice Expanders form a cascade connection. The input Audio signals are output at their input level from the MAIN OUT jacks (see the next page).
	AUX. IN (L/R)	Similar to the MAIN IN jacks, these input jacks are used for a cascade connection, and output the input Audio signals from the AUX. OUT jacks.
④ Audio Signal Output Jacks	MAIN OUT (L/R)	These jacks output all the Audio signals. When multiple Voice Expanders form a cascade connection, the Audio signals of the unit are mixed with the Audio signals input from the MAIN IN jack, and then output (see the next page). Note that the pin jacks and phone jacks differ only in shape but output identical signals.
	AUX. OUT (L/R)	Similar to the MAIN OUT jacks, these jacks output all the Audio signals. In case of a cascade connection, the Audio signals of the unit are mixed with the Audio signals input from the AUX. IN jack, and then output. Note that the pin jacks and phone jacks differ only is shape but output identical signals. *The output level from AUX. OUT can be separately set for each Tone Group. Use these jacks when you wish to simultaneously output from MAIN OUT and to an external effector, such as Reverb, then control the way the effect is applied according to the Tone Group.
	HEADPHONES (Front panel)	This jack performs stereo output of Audio signals to a headphone set. Only the signals of the unit connected to the headphones are output, and the input signals of neither MAIN IN nor AUX. IN are output.

■ Sample Connections

[For a full system using MDX-1] (For details, refer to the "HX-SERIES EXPANDED SYSTEM USER'S GUIDE.")

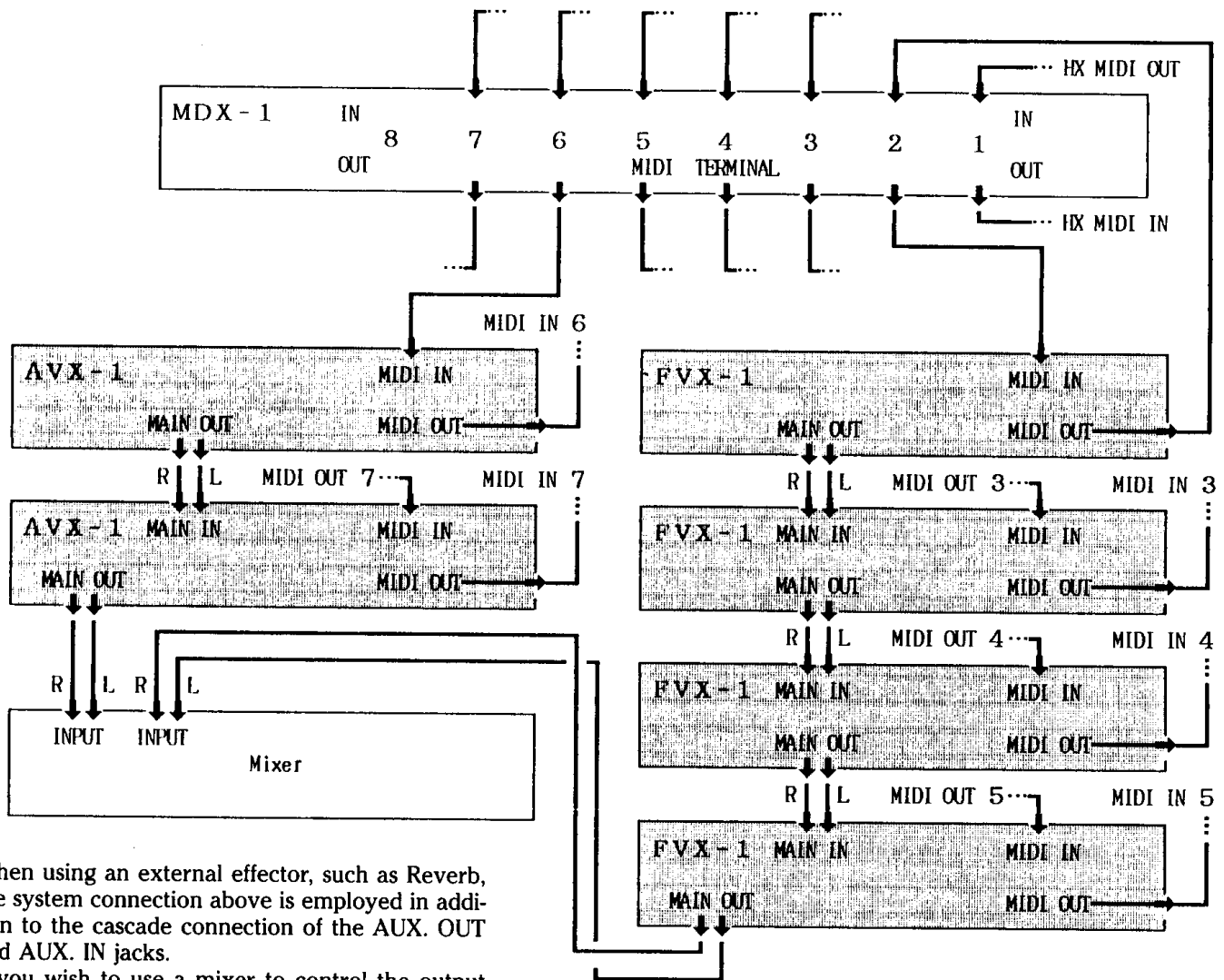

*When using an external effector, such as Reverb, the system connection above is employed in addition to the cascade connection of the AUX. OUT and AUX. IN jacks.

*If you wish to use a mixer to control the output level at each Voice Expander, connect the MAIN OUT jacks of each unit to the mixer in parallel.

[For a system in which Performance data is sent directly from HX to two FVX-1 units]

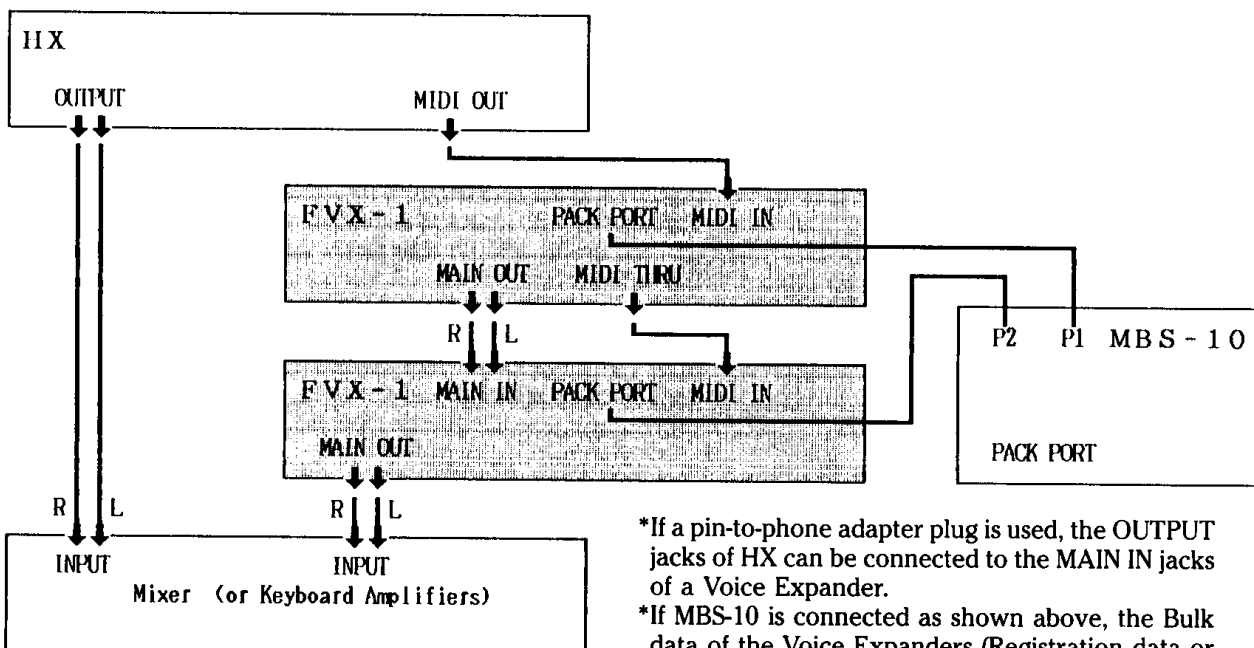

*If a pin-to-phone adapter plug is used, the OUTPUT jacks of HX can be connected to the MAIN IN jacks of a Voice Expander.

*If MBS-10 is connected as shown above, the Bulk data of the Voice Expanders (Registration data or User Voice data) can be transferred to and from a RAM Pack.

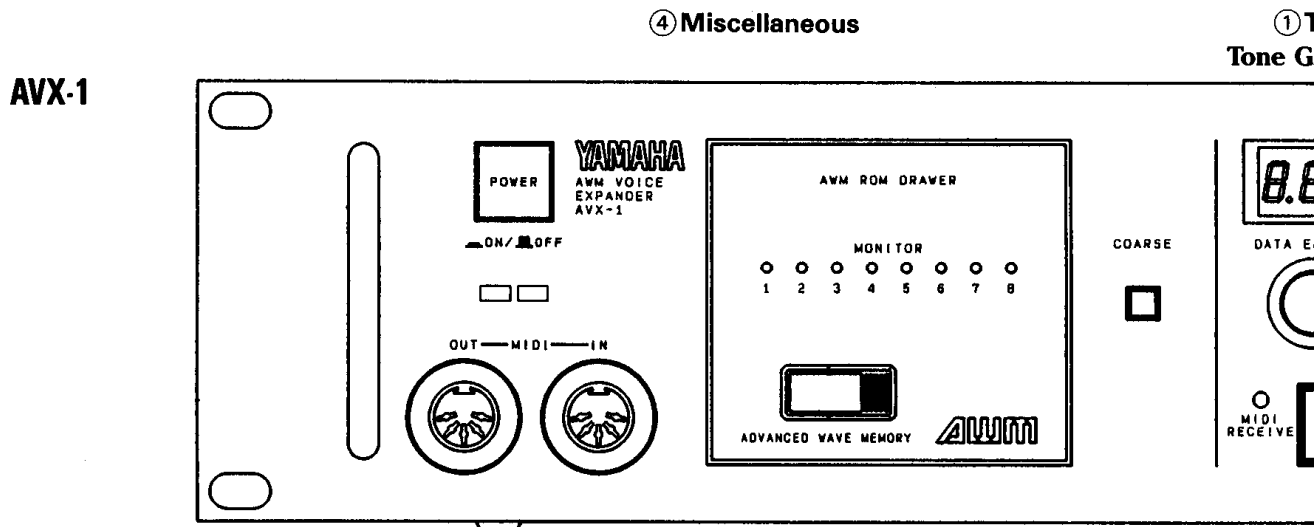
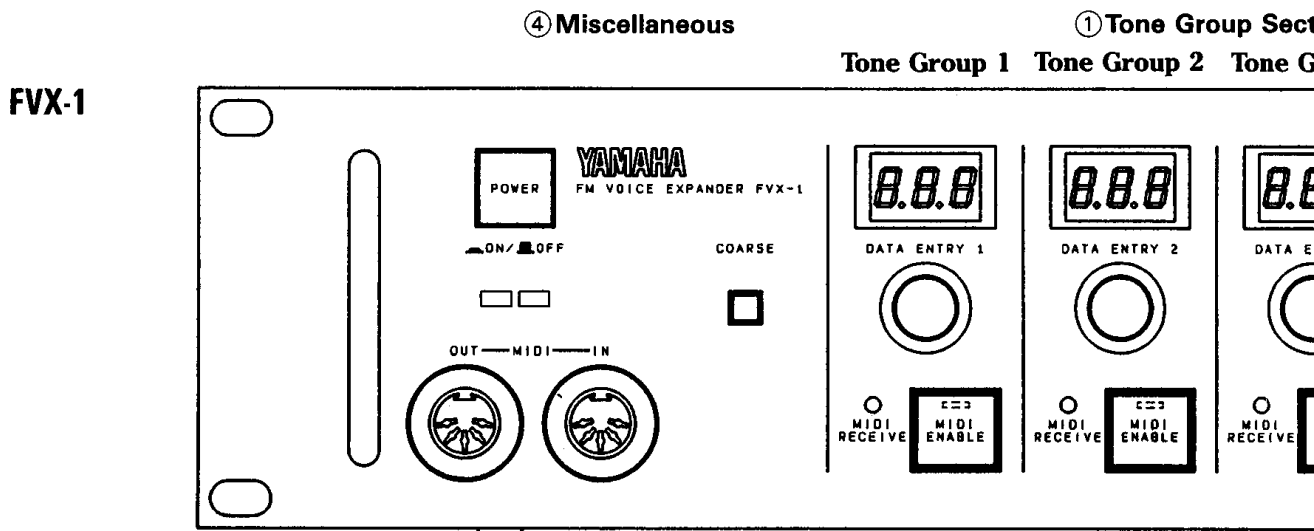

① Tone Group Section

Tone Group Display These displays (red) show the data setting for each Tone Group based on the functions selected by the selector switches at the Common Section.

DATA ENTRY These are click-type rotary switches for changing the data displayed at the Tone Group displays.

MIDI ENABLE These switches enable or disable the reception of MIDI channel messages.

MIDI RECEIVE These lamps light up to indicate when MIDI signals have been received.

② Common Section

Common Display This display (green) usually shows the currently set Registration No. When setting the effector, Vibrato, and functions, the display changes according to the values being set.

Selector switches These switches are used when selecting the functions to be set for each Tone Group. At each Tone Group display, the currently set data of the function of the switch (seven switches excluding the REGIST switch) that has been pressed ON is displayed. The REGIST switch is used to recall and/or edit a memorized Registration.

SHIFT (CONFIRM) This switch is used to shift to the function (purple) shown at the lower row of each selector switch.

MEMORY Press this switch to memorize a Registration that is set at the panel. With FVX-1, it is also used during Voice Copy and Voice Edit operations.

ction

② Common Section

③ Main Control Section

Group 3 Tone Group 4

Selector switches

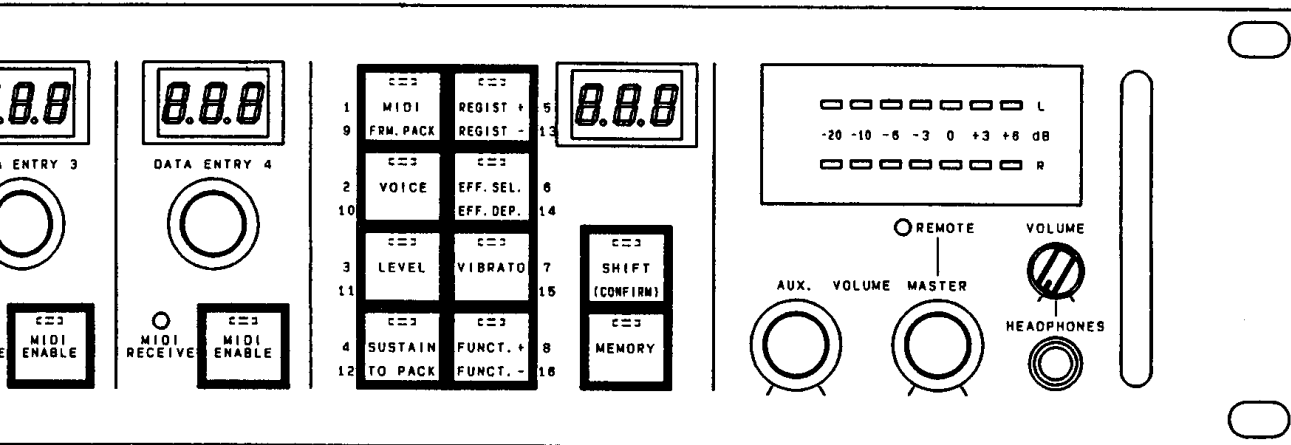

Tone Group Section

② Common Section

③ Main Control Section

Group 1 Tone Group 2

Selector switches

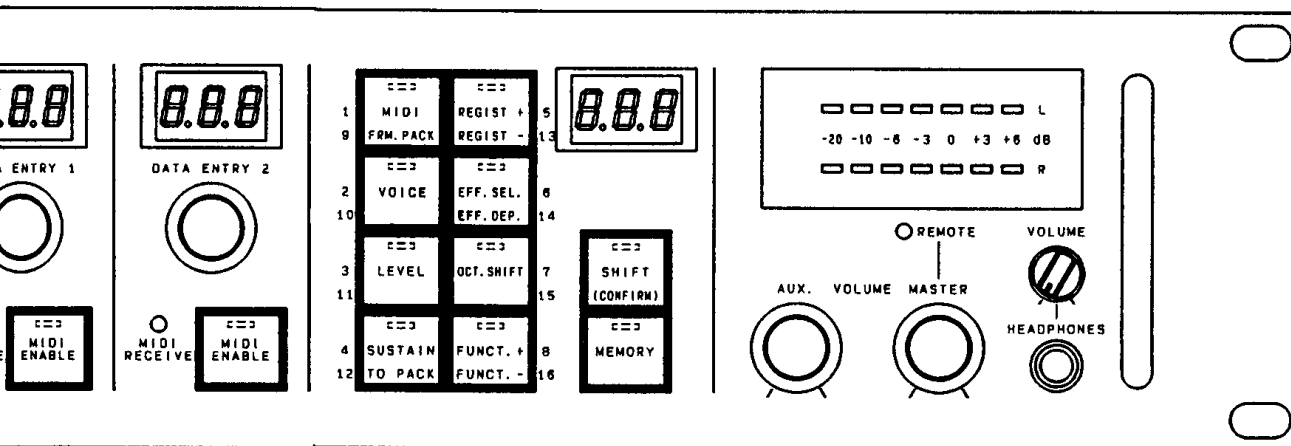

③ Main Control Section

MASTER volume

This controls the overall volume of the unit.

Level meter

The lamps of this display indicate the overall volume level of the unit that is being output from MAIN OUT.

REMOTE

This lamp lights up when the Master Volume MIDI signal is received from an external device.

Master AUX. volume

This controls the overall volume level of the unit that is being output from AUX. OUT.

Headphones VOLUME

This controls the volume level that is being output from the HEADPHONES jack.

HEADPHONES jack This jack connects a headphone set.

④ Miscellaneous

COARSE

This switch is used to change the data values (only data with a variable range of 100 steps or more) displayed at a Tone Group Display in 10-step units.

AWM ROM DRAWER (AVX-1 only)

This drawer-type box is used for inserting your AWM Voice Packs (eight maximum) and installing them in the unit. (→see page 8)

POWER switch

This turns the power of the unit ON or OFF. It is also used to reset the unit.

MIDI jacks

This jack is used to connect a MIDI-compatible external device.

■ Main Specifications

- **Tone Generators** FVX-1: FM Tone Generator (8 operators)
 AVX-1: AWM Tone Generator
- **Soundable Range** FVX-1: 88 keys (A₋₁ to C₇)
 AVX-1: 88 keys (A₋₁ to C₇)
- **No. of Tone Groups / The Key Modes** FVX-1: 4 Tone Groups/8-note polyphonic
 AVX-1: 2 Tone Groups/8-note polyphonic (or 1 Tone Group/16-note polyphonic)
- **No. of Voices** FVX-1: Max. 504 voices (248 preset voices+248 user voices+8 common user voices)
 AVX-1: Max. 8 voices (according to the AWM Voice Packs installed)

■ The Signal Flow [For a full system using MDX-1]

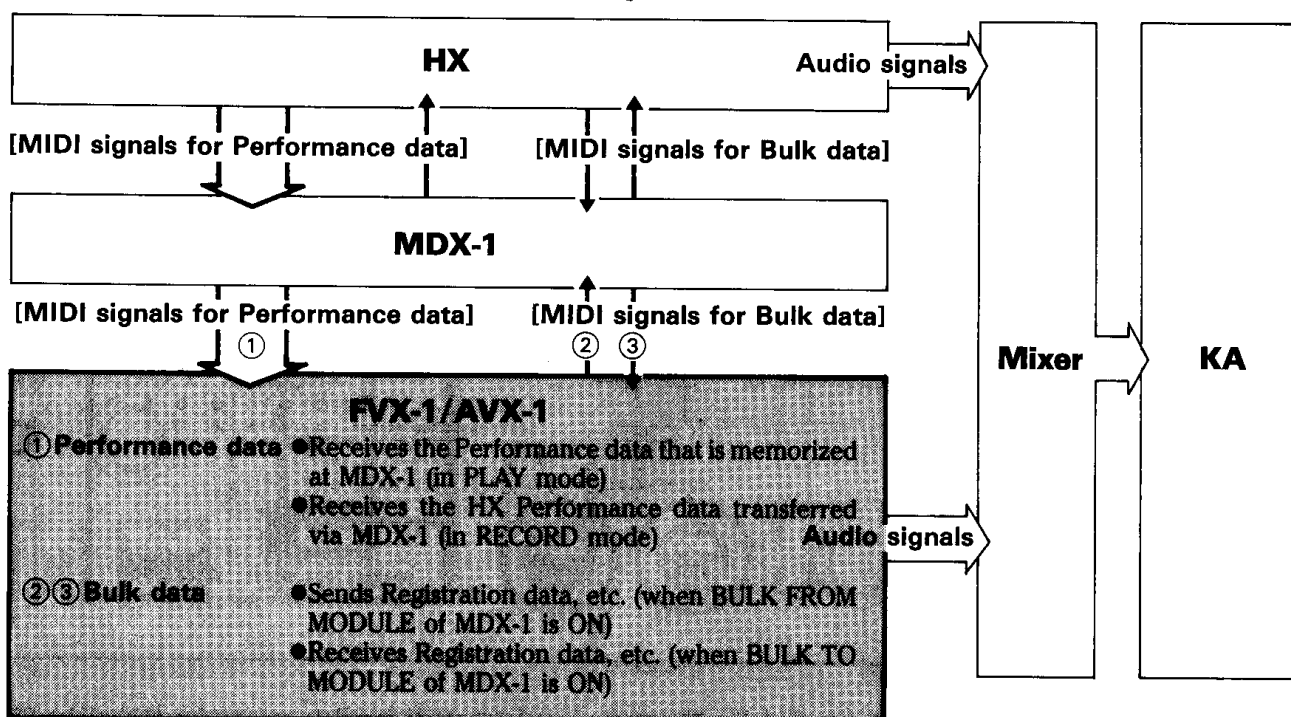

[For a system in which Performance data is sent directly from HX]

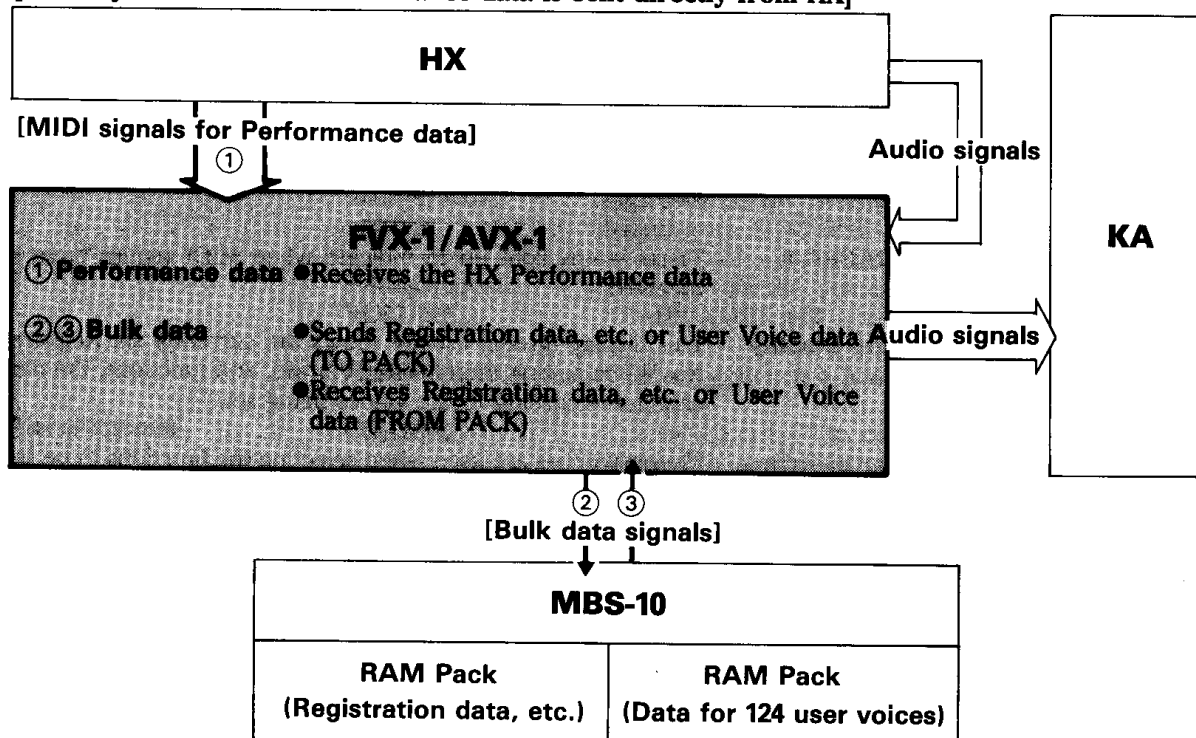

■ Relationship Between the Functions

*The functions ranging from MIDI ENABLE to REGIST. CHANGE ENABLE can be separately set for each Tone Group.

*The broken line indicates the AVX-1 functions.

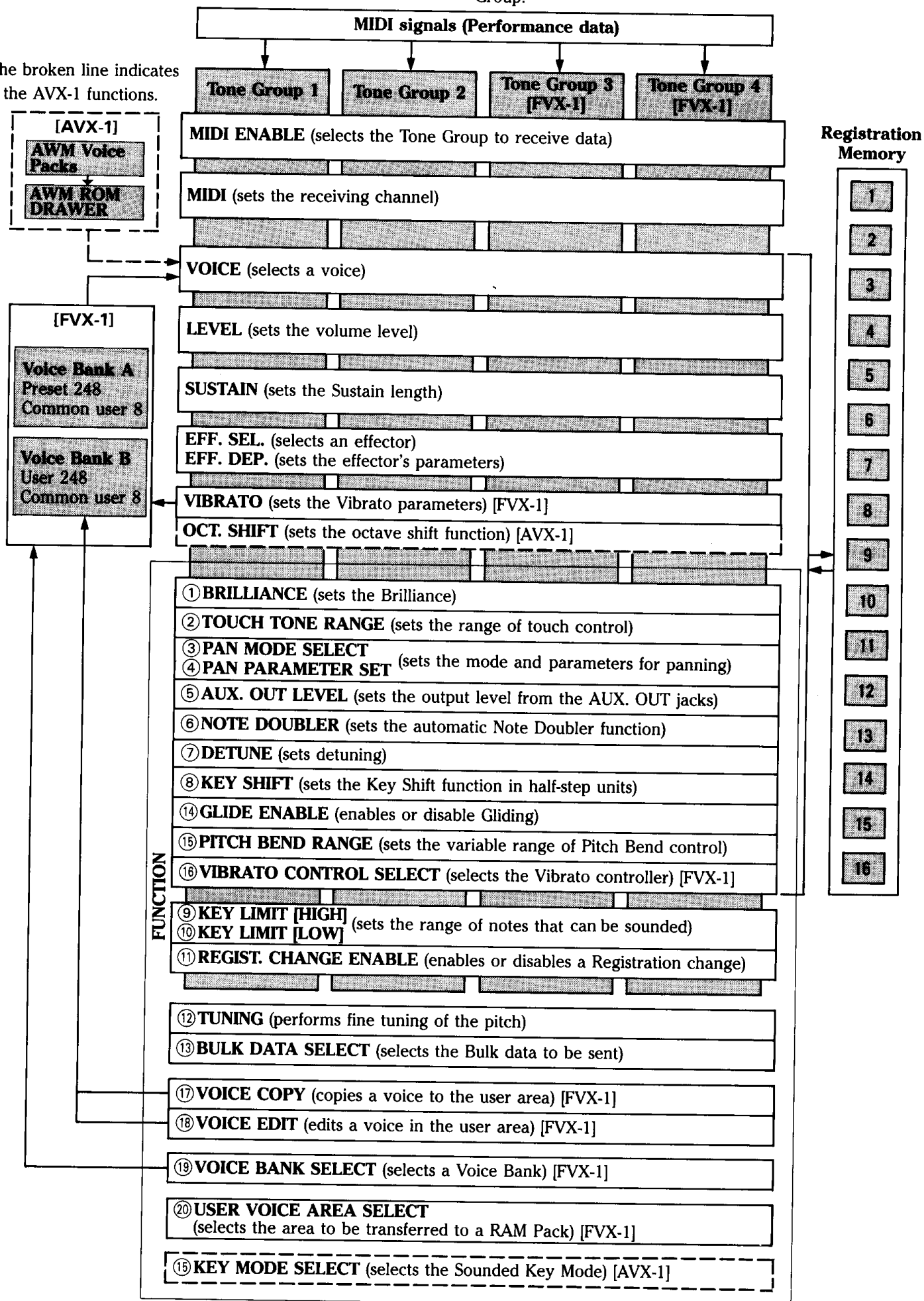

(The encircled numerals above indicate the Function Nos.)

Overview

- Installing AWM Voice Packs (VOICE ROM Packs that contain AWM Tone Generator data) into the AVX-1 enables the unit to produce sound.
- One of two types of AWM Voice Packs can be used: Type 1 (common to Electone HS-8) or Type 2 (one voice is produced by multiple Packs).

- To install the AWM Voice Packs into the unit, pull out the AWM ROM DRAWER at the front panel and insert them in the DRAWER.
- When using Voice Pack Type 2 (one voice is produced by multiple Packs), pay attention to the order in which the Packs are inserted in the DRAWER.

Installation Procedure

① Switch OFF the power of the unit.

CAUTION: Always make sure the power is turned OFF before opening the DRAWER.

② Pull the DRAWER out of the unit.

First, press the right side of the handle attached to the front of the DRAWER to project the handle. After using the projected handle to pull the DRAWER halfway out, support the DRAWER with your other hand to slowly pull out the DRAWER.

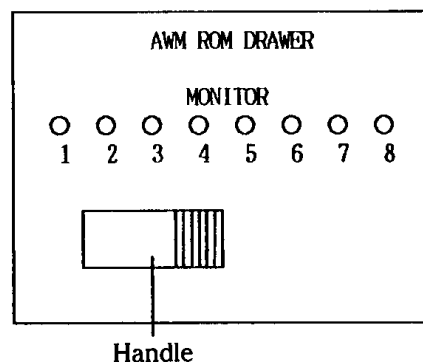

③ Install the Voice Packs into the slots in the DRAWER.

For insertion of the Voice Packs, the DRAWER is provided with eight slots that are numbered from 1 to 8. Follow the instructions below to securely insert the Voice Packs.

- ▶ **Multiple Packs comprising one voice:** Starting from the lowest slot number, insert the Voice Packs in the sequence of the numbers provided on the Voice Packs. (For example, if one voice consists of three Packs, sequentially insert Packs 1/3, 2/3, and 3/3 in slots 1, 2, and 3.)

CAUTION: If the Voice Packs are inserted out of sequence or not inserted in consecutive slots, sound will not be produced.

- ▶ **Each Pack produces one voice:** The Voice Packs can be inserted into any slot.

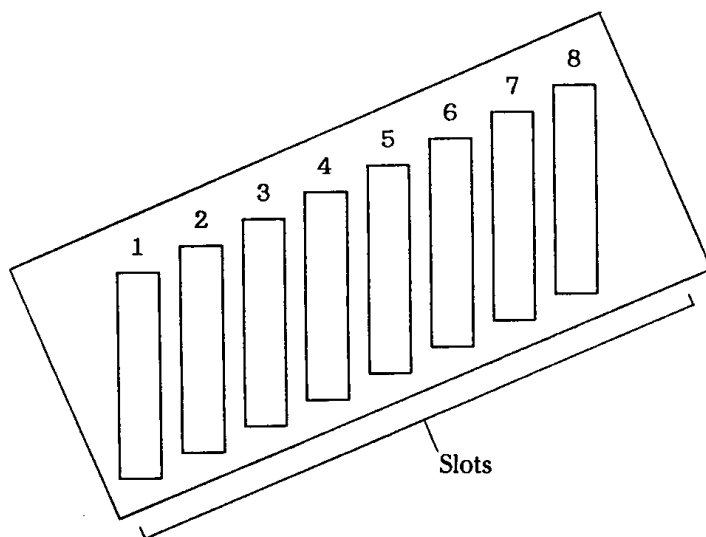

④ Put the DRAWER back into the unit, then turn ON the power.

Hold the DRAWER with both hands, as in Step ②, then slowly push it back into the unit. After the DRAWER is securely installed, turn ON the power. When the power is turned ON, the MONITOR lamps corresponding to the slots containing Voice Packs will light up, indicating that AVX-1 is capable of producing sound.

NOTE: If the MONITOR lamps of the slots that contain Voice Packs do not light, turn OFF the power, open the DRAWER, and check that the Voice Packs are correctly inserted. If the DRAWER is improperly installed or if compatible Voice Packs are not installed, [] is displayed on the Common Display. (→see page 55)

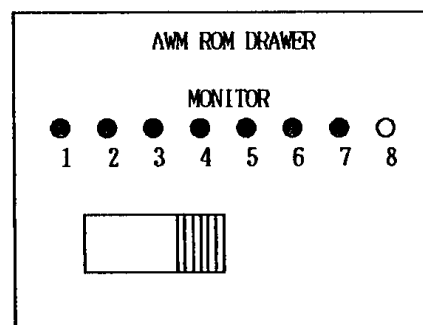

The Power-On Status

- When the unit's power is turned OFF, the currently set data is backed up by a built-in battery.
- When the power is turned ON again, the panel status that was valid when the power was last turned OFF is recalled to the panel so that you can preserve the contents of various types of data.
- The data that can be backed up consists of all parameters and data of the functions that can be set at the unit (except at the Main Control Section). (See the table below.)

[The Data That Can Be Backed Up]

The data that is set at the unit		User voices (248) Common User voices (8) VIBRATO (for individual voices) Panel settings Other settings ● VOICE BANK SELECT (FVX-1) ● KEY MODE SELECT (AVX-1) ● TUNING, etc.
The data that is set for each Tone Group		
The data memorized in Registration Memory 1-16 (→for details, see page 39)		
● VOICE Nos. ● LEVEL ● SUSTAIN LENGTH ● EFFECTOR SELECT ● EFFECTOR PARAMETERS ● OCTAVE SHIFT (AVX-1)	● BRILLIANCE ● TOUCH TONE RANGE ● PAN MODE SELECT ● PAN PARAMETER SET ● AUX. OUT LEVEL ● NOTE DOUBLER	● DETUNE ● KEY SHIFT ● GLIDE ENABLE ● PITCH BEND RANGE ● VIBRATO CONTROL SELECT (FVX-1)
		● MIDI ENABLE ● MIDI channels ● KEY LIMIT [HIGH] [LOW] ● REGIST. CHANGE ENABLE

Resetting

- When the operation shown in the box below is performed, the data for all functions is reset to their default settings (the initial factory-preset status).
- These default settings are very convenient when you first use your Voice Expander or when you wish to set Registrations or perform voice editing from scratch.
- The range of data which is reset corresponds to the range of data that can be backed up (see the table above).

NOTE: "The Default Settings" in Chapter VI, "OTHER INFORMATION," list the status and data settings that become valid when the unit is reset. Be sure to refer to this list when setting Registrations. (→see page 49)

CAUTION: Resetting the unit erases all of the data that has been backed up in the unit up to that time. Any data you wish to save should be transferred before the reset operation as follows:

- ▶ **MDX-1:** Execute a BULK FROM MODULE job to transfer the data to MDX-1 and write the data on a disk together with the Performance data. (→Refer to the "MDX-1 USER'S GUIDE.")
- ▶ **RAM Pack:** Connect MBS-10 then perform a To Pack operation to write the data to a RAM Pack. (→see pages 42 and 43)
- ▶ **MDR-2P:** Perform recording in NORMAL mode to write the data to a disk. (→Refer to the "MDR-2P USER'S GUIDE.")

[The Reset Operation]

First, turn OFF the POWER switch. Next, while pressing [MIDI ENABLE] ① of the rightmost Tone Group (FVX-1: Tone Group 4; AVX-1: Tone Group 2), turn the POWER switch ② back ON.

After turning ON the POWER switch, keep the MIDI ENABLE switch depressed for about five seconds more.

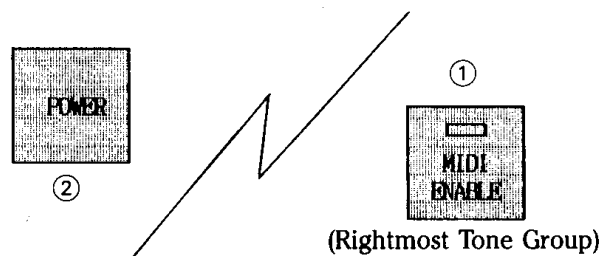

Level Control of Each Tone Group

① Expression Pedal

The volume level of each Tone Group is initially controlled by the Expression Pedal of the connected device, such as HX. The data of the Expression Pedal is sent as a MIDI channel message (with HX, this message is one of the control changes that are sent/received using Channel 16), and that signal is received by the Voice Expander. (→see page 13)

② LEVEL

The LEVEL function at the panel lets you set a 25-step volume level ranging from 0 to 24 for each Tone Group. (→see page 15)

③ AUX. OUT LEVEL

In case Reverb or another effect is output from AUX. OUT, it is possible to set the AUX. OUT level for each Tone Group. (→see page 24)

Overall Level Control of the Unit

④ MASTER AUX. VOLUME

The overall volume of the unit which is output from AUX. OUT can be set separately from the output level from MAIN OUT. (See the table below.)

⑤ HEADPHONES VOLUME

The output level to a headphone set can be independently controlled. (See the table below.)

⑥ MASTER VOLUME

This lets you control the overall volume level of the unit which is output from MAIN OUT and AUX. OUT. The level meter indicates the volume level based on the MASTER VOLUME setting. Note that the input levels from MAIN IN and AUX. IN cannot be controlled. (See the table below.)

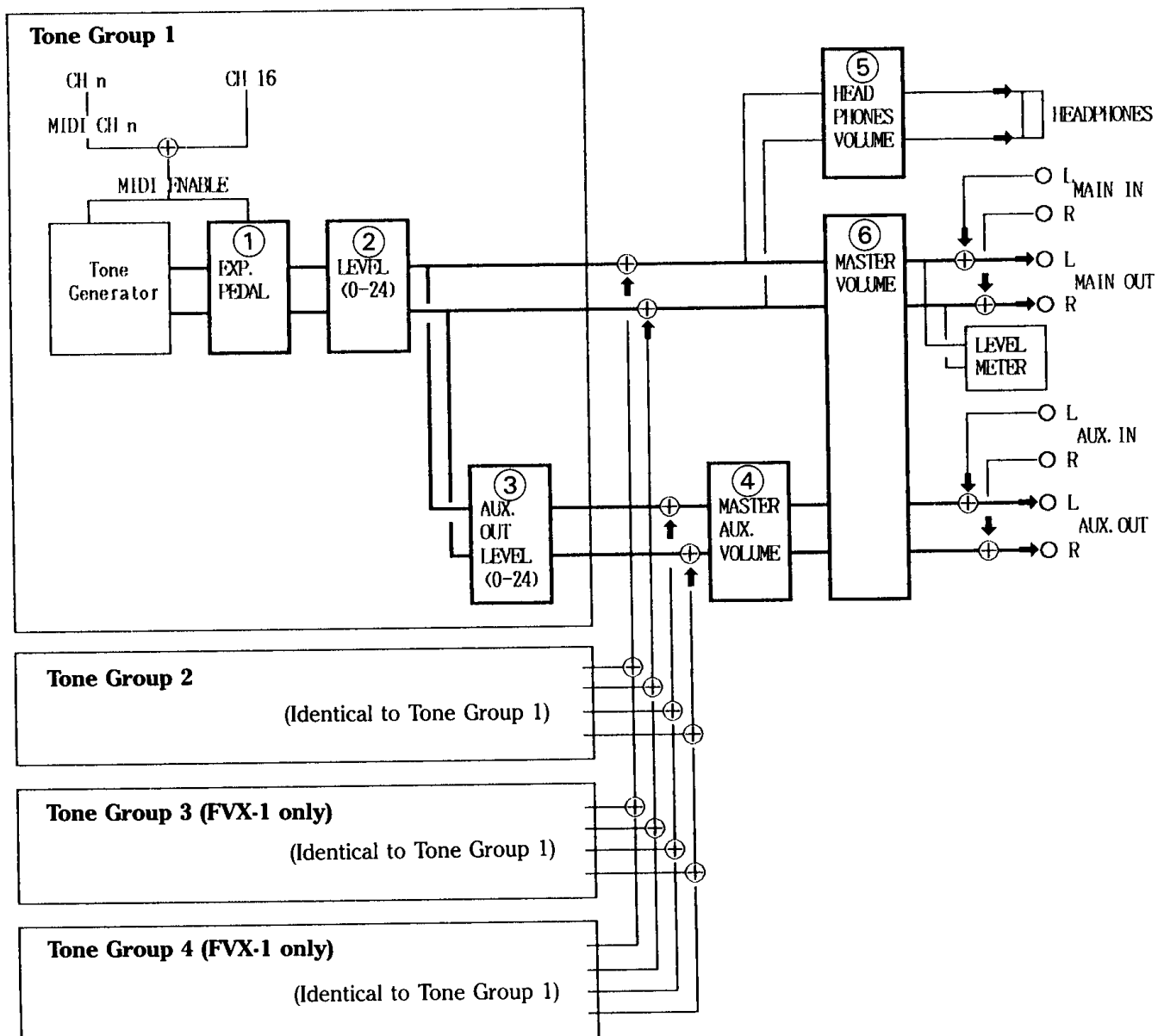

Play the HX upper keyboard to produce the sounds of Voice No. 1 in Tone Group 1.

For a full system using MDX-1

For sending Performance data from HX

① Prepare to send MIDI signals.

- ▶ Make sure the MIDI cables are properly connected. (→refer to page 4 and to the "MDX-1 USER'S GUIDE")
- ▶ Set MDX-1 to MAIN mode, then set the parameters of Track [01] and [02] as shown below. (→For details on this setting, refer to the "MDX-1 USER'S GUIDE.")

① Prepare to send MIDI signals.

- ▶ Make sure the MIDI cables are properly connected. (→see page 4)

TRACK	MODE	I N		O U T		I N P U T F I L T E R				
		TRM	CH	TRM	CH	PB	AF	PC	CC	
01	Test	REC	1	1	2	1	—	—	—	—
02		REC	1	16	2	16	—	—	—	—
03	xxxxxxxxxxxx	—	1	1	1	1	—	—	—	—
04	xxxxxxxxxxxx	—	1	1	1	1	—	—	—	—

*Perform the operation below for the Voice Expander that is connected to MIDI OUT of Terminal 2 of MDX-1.

Panel Operation of the Voice Expander

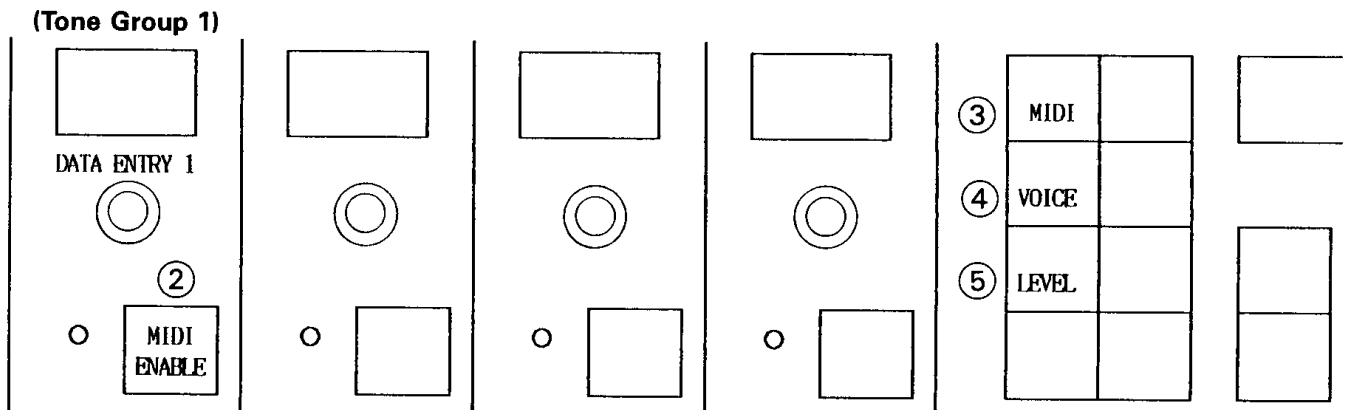

② Set [MIDI ENABLE] of Tone Group 1 to ON.

Setting this switch to ON enables Tone Group 1 to receive MIDI signals. (→see page 12)

③ Set [MIDI] to ON, then set the Tone Group 1 Display to [001].

Setting the MIDI switch to ON lets you set the MIDI receiving channel for the Tone Groups, so rotate the DATA ENTRY (a rotary switch) and set Channel 1. Note that Channel 16 is always set to receive. (→see page 13)

④ Set [VOICE] to ON, then set the Tone Group 1 Display to [001].

Setting the VOICE switch to ON lets you choose a voice for the Tone Groups, so rotate DATA ENTRY of Tone Group 1 to choose Voice No. 1. (→see page 14)

⑤ Set [LEVEL] to ON, then set the Tone Group 1 Display to [024].

Setting the LEVEL switch to ON lets you set the volume level for the Tone Groups, so rotate DATA ENTRY of Tone Group 1 to set a volume level of 24. (→see page 15)

Performing on the HX

⑥ Press the keys of the upper keyboard.

The Performance data from the upper keyboard is received by Tone Group 1, and Voice No. 1 is sounded at volume level 24 (maximum). And if the Expression Pedal of HX is used, you can control the level of Tone Group 1.

[Check Points In Case No Sound is Produced]

- ▶ Is [MASTER VOLUME] of the Voice Expander set to Level 0?
- ▶ Is the mixer or amplifier properly connected?
- ▶ Is MDX-1 or HX properly connected?
- ▶ Are the MDX-1 parameters correctly set?
- ▶ Are you pressing the Expression Pedal? (If no sound is produced even when the Expression Pedal is pressed, try moving the Expression Pedal.)

II-1 MIDI ENABLE (Choosing the Tone Groups to be Sounded)

Overview

- The MIDI ENABLE switch enables or disables the reception of MIDI signals (Channel Messages) at each Tone Group.
- Setting a MIDI ENABLE switch to ON enables reception for that Tone Group; setting it OFF disables the reception for that Tone Group. Since each Tone Group can be separately enabled or disabled, the MIDI ENABLE switch operates selectively like the ENSEMBLE switch function of the Electone.
- The ON/OFF status of this switch is not memorized to Registration Memory. When you wish to keep a specific Tone Group from being sounded by changing to another registration, memorize the latter registration with its volume level set to "0". (→see page 15)
- This switch can also be used in order to memorize the registrations of each Tone Group. (→see page 41)

Procedure

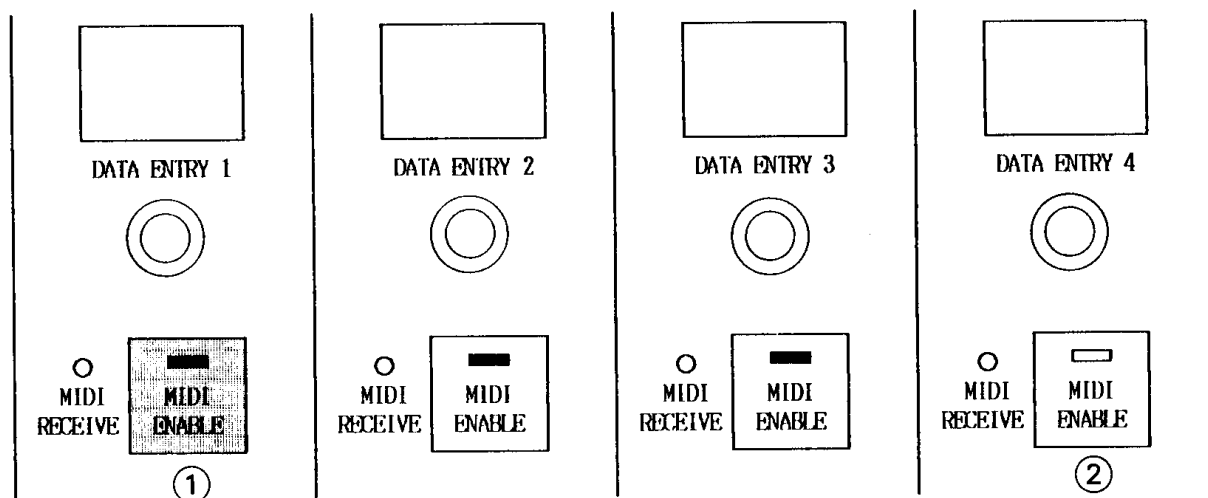

- ① Set [MIDI ENABLE] to ON at each Tone Group that is to receive data (that is to be used).

When the lamp of a MIDI ENABLE switch lights up, reception is enabled for that Tone Group, permitting reception of the signals of the MIDI channel set using the [MIDI] function and of Channel 16. (→see page 13)

NOTE: When the MIDI ENABLE switch is set from OFF to ON, the signal which turns OFF Sustain and the signal that returns Pitch Bend to its center value are generated.

[The MIDI RECEIVE Lamps]

The MIDI RECEIVE lamp to the left of each MIDI ENABLE switch lights up to indicate that its Tone Group has received MIDI signals.

When MIDI ENABLE has been set to ON and the signals sent over the channel set by the MIDI function and over Channel 16 have been received, this lamp lights up for a fixed interval only. (→see page 13)

- ② Set [MIDI ENABLE] to OFF at each Tone Group that is not to receive data (that is to be disabled).

When the lamp of a MIDI ENABLE switch is turned off, reception is disabled for that Tone Group. Regardless of the setting of the MIDI channel, volume LEVEL, etc, therefore, that Tone Group is not sounded.

Overview

- The MIDI function sets the MIDI channel to be used for receiving data at each Tone Group, allowing any channel from 1 to 16 to be set.
- The MIDI signals of Channel 16 will always be received regardless of this setting. If reception is performed using Channel 16, therefore, overall control of all Tone Groups can be achieved (when all MIDI ENABLE switches are ON).
- Though the receiving channel can be set for each Tone Group, the settings are not memorized to Registration Memory. Consequently, it is not possible to switch the receiving channel of a single Tone Group by changing the registration.
- The MIDI switch is also used during the From Pack operation.

Procedure

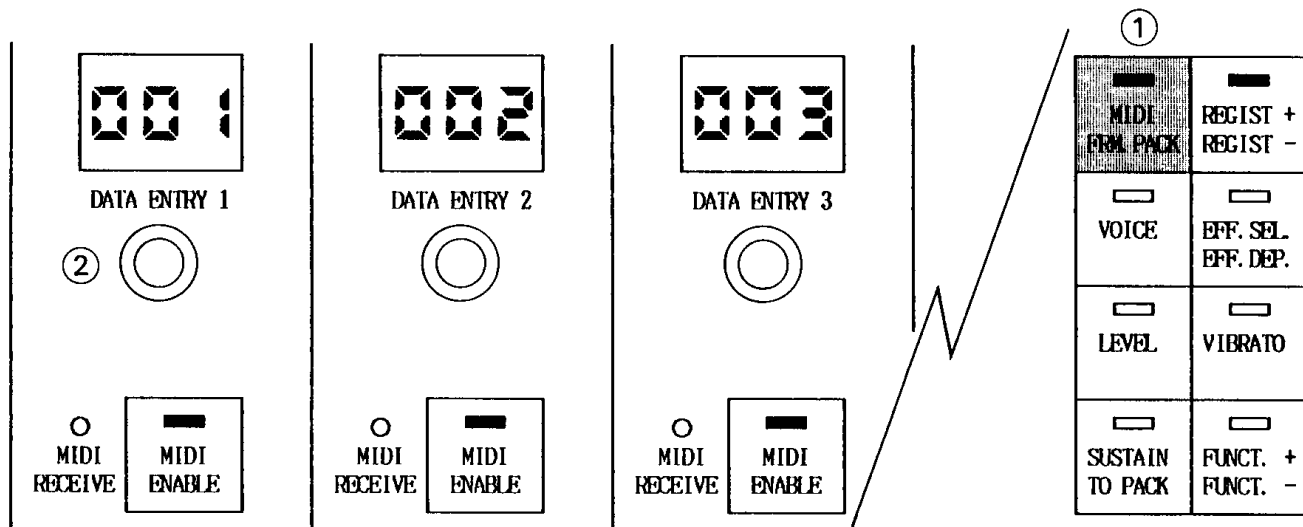

① **Set [MIDI] to ON.**
 Setting the MIDI switch within the selector switches to ON lets you set the receiving channel for each Tone Group. At this time, the currently set receiving channel is displayed at each Tone Group Display.

② **Use DATA ENTRY at each Tone Group to set the receiving channel.**
 Rotating DATA ENTRY in the clockwise direction increases the Channel No.; rotating it in the counter-clockwise direction decreases the Channel No.

▶ **Variable range:** [00 1] to [0 15]
 (CH 1) (CH 16)

NOTE: If the same channel is set for all Tone Groups, you can sound all Tone Groups using the Performance data of one channel.

NOTE: If different channels are set for multiple Tone Groups, the Performance data of the respective channels can be sounded at multiple Tone Groups so that different performances can be simultaneously be sounded from a single unit. If CH 1 is set for Tone Group 1 and CH 2 is set for Tone Group 2, then the signals of CH 1 and CH 2 are sent simultaneously, for example, Tone Group 1 is sounded according to the Performance data of CH 1 while Tone Group 2 is sounded according the Performance data of CH 2.

[Relationship Between the receiving MIDI Channels and MIDI ENABLE] (When sending the signals of CH 1, CH 2, and CH 16)

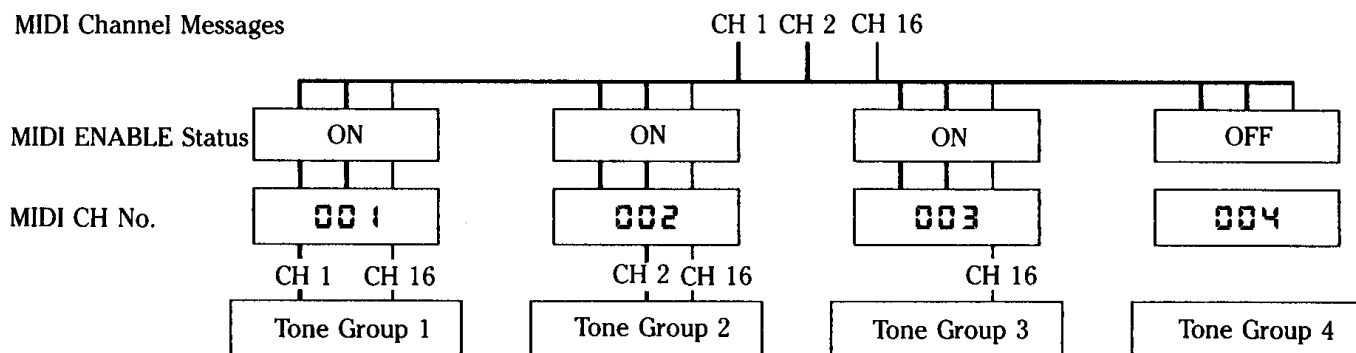

III-1 VOICE (Choosing the Voices)

Outline

- The VOICE function lets you choose the voice to be sounded from each Tone Group.
- Voice selection is based on the Voice No. displayed at each Tone Group Display.
- The quantity of voices that can be chosen are different for FVX-1 and AVX-1.
- Voices not only can be chosen for individual Tone Groups but also can be memorized to Registration Memory. By memorizing registrations with different voice selections, therefore, voices can be switched within the same Tone Group by changing the registration.
- Besides choosing a different voice for each Tone Group, you can also choose the same voice for multiple Tone Groups to produce a rich, layered sound.

Operation

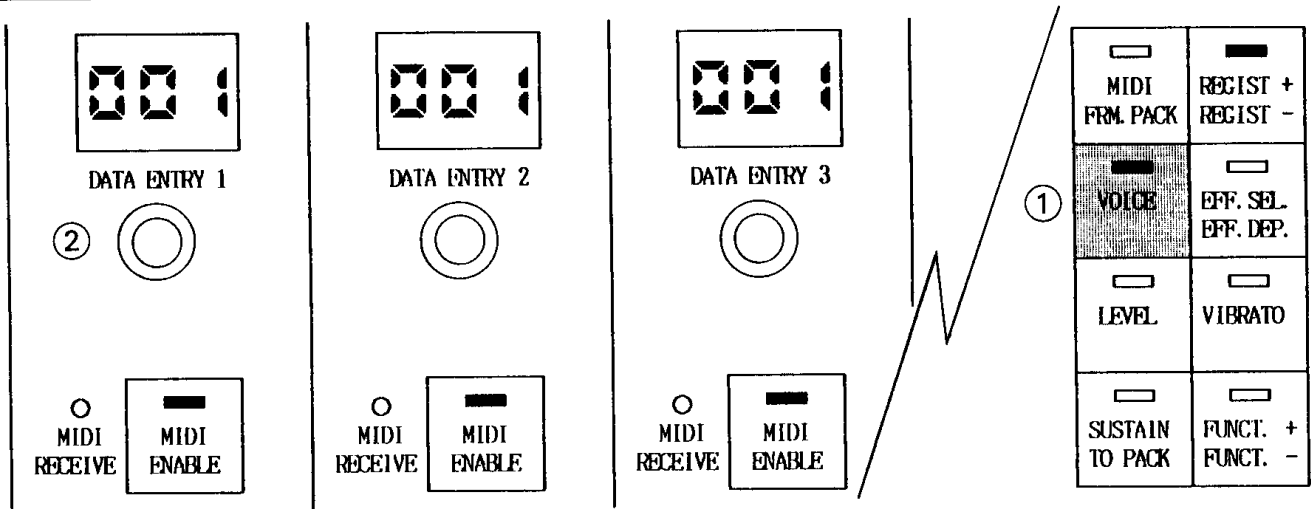

① Set [VOICE] to ON.

Setting the VOICE switch within the selector switches to ON lets you choose the voice for each Tone Group. At this time, the currently set Voice No. is displayed at each Tone Group Display.

② Use DATA ENTRY at each Tone Group to choose a voice.

Rotating DATA ENTRY in the clockwise direction increases the Voice No. one at a time; rotating it in the counter-clockwise direction decreases the Voice No. one at a time.

- ▶ **FVX-1:** One out of 256 voices can be selected, within a range of [00 1] to [248] and [00 1] to [008]. (See "Choosing Voices for FVX-1" on the right.)

NOTE: With FVX-1, if you rotate DATA ENTRY while pressing the COARSE switch, the Voice No. can be increased (or decreased) by 10 Voice Nos. at a time.

- ▶ **AVX-1:** One voice out of the voices installed in the AWM ROM DRAWER can be chosen. For example, if three voices are installed, you can select the Voice Nos. of [00 1] to [00 3]. (⇒see page 8)

[Choosing Voices for FVX-1]

With FVX-1, a voice can be chosen from the range of [00 1] to [248] and from [00 1] to [008]. The Voice Nos. [00 1] to [248], however, correspond to the 248 voices that are respectively memorized in Voice Banks A and B.

Voice Bank A	248 Preset voices	8 Common User voices
Voice Bank B	248 User voices	

- ▶ Voice Bank A or B is chosen using the VOICE BANK SELECT function (Function 19). (⇒see page 37)
- ▶ For information on the 248 Preset voices, see "The Preset Voices" in Chapter VI, "OTHER INFORMATION."
- ▶ The 248 User voices consists of the voices you define yourself using Voice Copy or Voice Edit and then register as arbitrary Voice Nos. (⇒see pages 31 and 32)
- ▶ The 8 Common User voices are the User voices that can be selected from either Voice Bank A or B. These voices are registered according to the frequency of use. (⇒see pages 31 and 37)
- ▶ In default status (after a reset is performed), the Preset voices 1 to 248 are copied to User voices 1 to 248, and the Preset voices 1 to 8 are copied to Common User voices 1 to 8.

Outline

- This feature sets the volume level of the voice to be sounded for each Tone Group.
- The volume is set while observing the numeric value (25 steps from Step 0 to Step 24) displayed at each Tone Group Display.
- This function is not the only way to control the volume. (→see page 10)
- The volume not only can be set for individual Tone Groups but also can be memorized to Registration Memory. By memorizing registrations with different volume settings, therefore, the volume can be changed within the same Tone Group by changing the registration.

Procedure

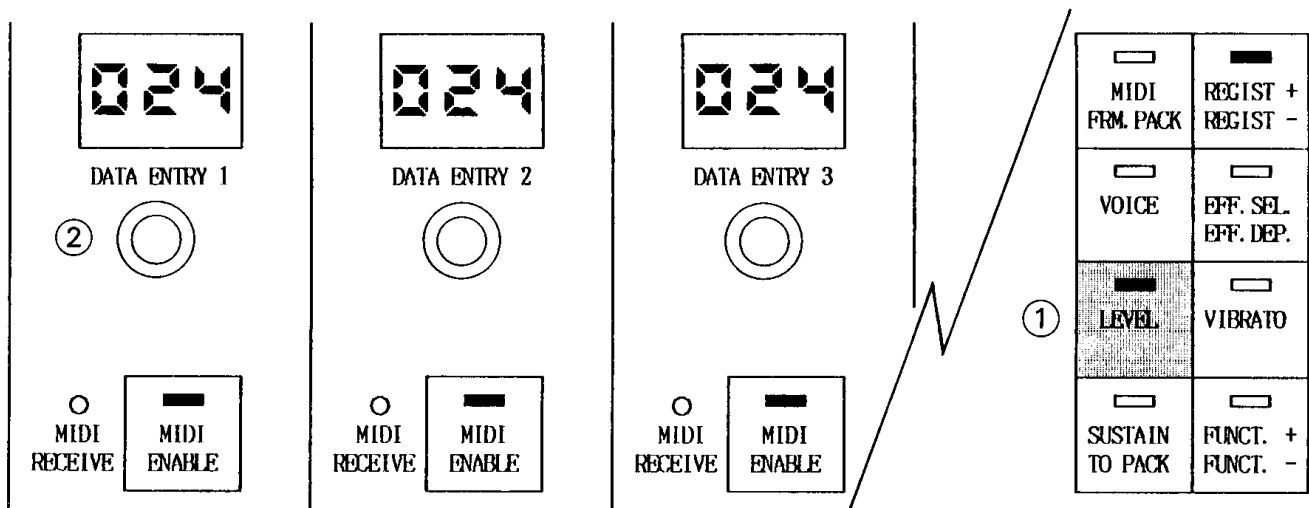

① Set [LEVEL] to ON.

Setting the LEVEL switch within the selector switches to ON lets you set the volume for each Tone Group. At this time, the currently set level is displayed at each Tone Group Display.

② Use DATA ENTRY at each Tone Group to set the volume level.

Rotating DATA ENTRY in the clockwise direction increases the numeric value and the volume; and rotating it in the counter-clockwise direction decreases the numeric value and the volume.

► **Variable range:** 25 steps from [000] to [024]
(OFF) (Maximum)

NOTE: When set to [000], the volume level becomes "0" and that voice is no longer sounded. When you wish to keep a specific Tone Group from being sounded by changing to another registration, memorize the latter registration with its volume level set to "0". (With the Electone, you can also memorize the ON/OFF status of ENSEMBLE at the Electone; with FVX-1, however, the ON/OFF status of MIDI ENABLE cannot be memorized to Registration Memory.)

Outline

- This function sets the Sustain Length (duration for which each note is sustained) to be applied to the sounded voices of each Tone Group.
- The Sustain Length is set while observing the numeric value displayed at each Tone Group Display.
- The Sustain ON/OFF status is switched by receiving a MIDI signal (Control Change) from the connected device.
- The Sustain Length not only can be set for individual Tone Groups but also can only memorized to Registration Memory. By memorizing registrations with different Sustain Length settings, therefore, the Sustain effect can be changed within the same Tone Group by changing the registration.
- The SUSTAIN switch is also used in To Pack operations, etc.

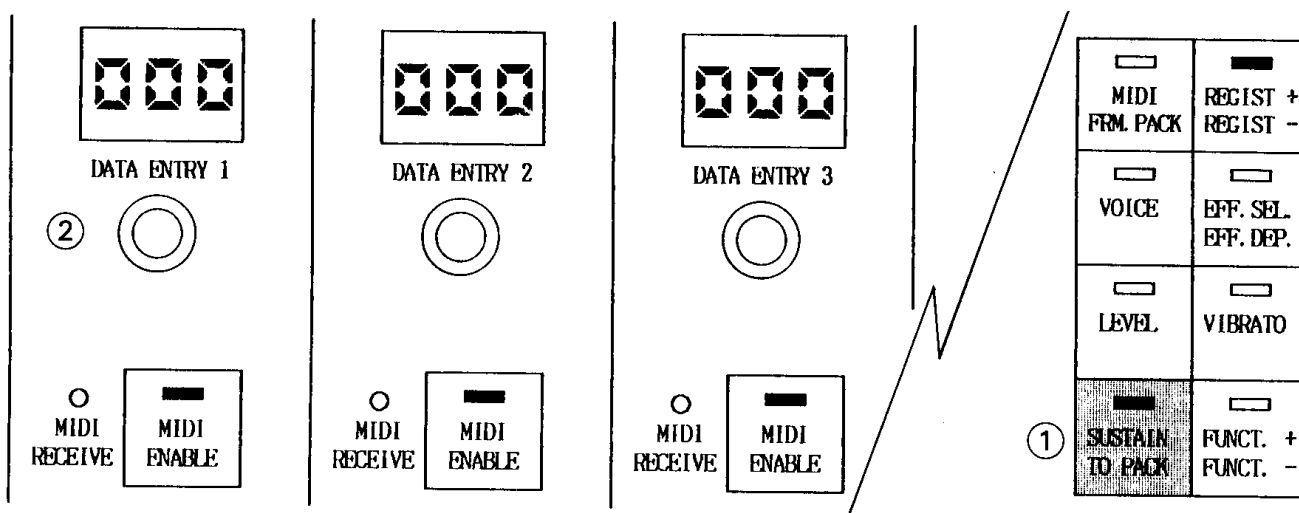
Procedure**① Set [SUSTAIN] to ON.**

Setting the SUSTAIN switch within the selector switches to ON lets you set the Sustain Length for each Tone Group. At this time, the currently set Length is displayed at each Tone Group Display.

② Use DATA ENTRY at each Tone Group to set the Length.

Rotating DATA ENTRY in the clockwise direction increases the numeric value and the Length; rotating it in the counter-clockwise direction decreases the numeric value and the Length.

► **Variable range:** 25 steps from [000] to [024]
(Shortest) (Longest)

NOTE: With AVX-1, certain voices (such as Piano, etc.) have a fixed Sustain Length. If [SUSTAIN] is set to ON while one of these voices is selected, [- - -] is displayed at that Tone Group Display to indicate that the Sustain Length cannot be set.

[The Sustain ON/OFF Status]

The Sustain ON/OFF status is controlled by the Sustain Length setting as well as by the reception of a MIDI signal sent from an external device. The Sustain ON/OFF data is transferred as a Channel Message of Control Change type. In case of HX, the SUSTAIN switch ON/OFF data of the panel (each keyboard) and the ON/OFF data of the Knee Lever (upper and lower keyboards) are sent over the channels of the respective keyboards. When a Voice Expander receives a Sustain ON signal, the Sustain effect is applied for the set Length; when it receives a Sustain OFF signal, the Sustain effect is disabled regardless of the set Length.

CAUTION: If a Sustain OFF signal is not received after a Sustain ON signal is received (in cases where the performance ends with the Sustain effect left ON, etc.), the Sustain effect remains valid until the Sustain OFF signal is received. If the Sustain ON signal is not received after a Sustain OFF signal is received, the Sustain effect remains disabled even if the Length is set to its maximum value.

Outline

- This function selects the Effector to be applied to each of the voices to be sounded.
- An Effector is selected while observing the three letters shown at each Tone Group Display.
- It is possible to select one of eight Effectors, four Reverbs (preset as the Program Effector area), or the OFF status.
- The parameters of the selected Effector can be changed as required. (→see page 18)
- The Effectors (or "OFF" status) not only can be selected for individual Tone Groups but also can be memorized to Registration Memory. By memorizing registrations with different Effector settings, therefore, the Effector can be changed within the same Tone Group by changing the registration.

Procedure

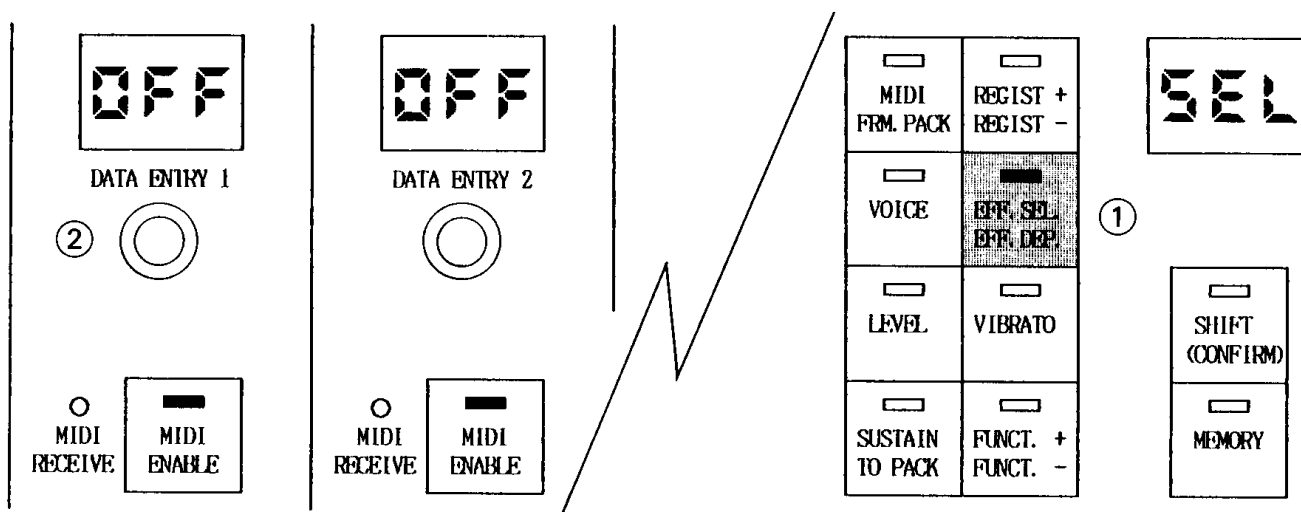

① Set [EFF. SEL.] to ON.

Setting the EFF. SEL. switch within the selector switches to ON lets you select the Effector for each Tone Group. At this time, [SEL] is displayed at the Common Display to prompt you to select an Effector.

Also, the currently selected Effector (or "OFF" status) is displayed using letters of the alphabet at each Tone Group Display.

② Use DATA ENTRY at each Tone Group to select an Effector.

The Effector statuses that can be selected are shown in the table to the right. Rotating DATA ENTRY in the clockwise direction moves Effector selection down through the table; rotating it in the counter-clockwise direction returns Effector selection toward the top of the table.

CAUTION: If either SYMPHONIC, CELESTE, TREMOLO, CHORUS, or Reverb 1-4 is selected for a voice, the Pan function will not operate for that voice. (→see page 23)

NOTE: With FVX-1, because the Effector status (including the OFF status) is preset for each voice, setting [VOICE] to ON and changing the Voice No. will also change the Effector setting.

NOTE: [PE 1] to [PE 4] represent a memory area that allows you to set Effectors that are not provided in the unit. In default status (after a reset), four types of Reverbs are programmed to this area.

Display	Effector Name
OFF	OFF
SŶñ	SYMPHONIC
CEL	CELESTE
PHR	PHASER
FLR	FLANGER
dEL	DELAY
WRH	WAH
TRE	TREMOLO
CHD	CHORUS
PE 1	Program Effector 1 (REVERB 1)
PE 2	Program Effector 2 (REVERB 2)
PE 3	Program Effector 3 (REVERB 3)
PE 4	Program Effector 4 (REVERB 4)

Outline

- This function sets the Effector parameters (or PRESET mode) for each Tone Group.
- The parameters are set for the Effector selected by EFF. SEL (Effector Select). The quantity of parameters that can be set vary with the Effector. (→see page 50).
- The parameters not only can be set for individual Tone Groups but also can be memorized to Registration Memory. By memorizing registrations with different parameters, therefore, the application of the Effector can be changed within the same Tone Group by changing the registration.

Procedure

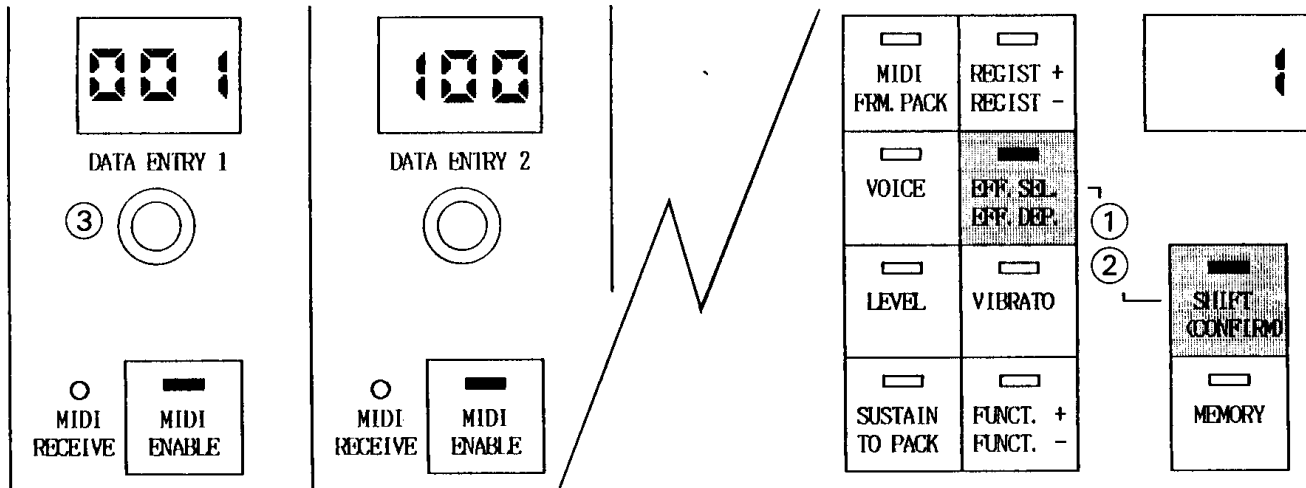

① While pressing [SHIFT], set [EFF. DEP.] to ON. Setting the EFF. SEL/EFF. DEP. switch to ON while pressing the SHIFT switch lets you set the Effector parameters for each Tone Group. The meanings of the numeric values displayed at each Display at this time are as follows:

- ▶ **Common Display:** The Parameter Nos. common to all Effectors are displayed using [1] to [7]. (See the table below.)
- ▶ **Tone Group Display:** The currently set Effector parameter values are displayed according to the Parameter No. displayed at the Common Display.

② While pressing [SHIFT], press [EFF. DEP.] the required number of times to select the desired Parameter No.

The [SHIFT]+[EFF. SEL./EFF. DEP] operation will advance the Parameter No. displayed at the Common Display one at a time. While referring to the table below, repeat this operation until the number of the parameter you wish to change is displayed at the Common Display.

CAUTION: As shown in the table below, the contents indicated by the Parameter Nos. vary with the Effector. If no parameter exists for the selected Parameter No. (indicated by “-” in the table), [- - -] is displayed at the Common Display.

[Correspondence Between the Parameter Nos. (Common Display) and the Effector Parameters] (→see page 50)

	1	2	3	4	5	6	7
SYMPHONIC	PRESET MODE	-	-	-	-	-	-
CELESTE	PRESET MODE	-	-	-	-	-	-
PHASER	STAGE	FREQUENCY	DEPTH	FEEDBACK	-	-	-
FLANGER	DELAY TIME	DEPTH	FREQUENCY	FEEDBACK	DIRECT LEVEL	DELAY LEVEL	-
DELAY	DELAY TIME	DEPTH	FREQUENCY	FEEDBACK	DIRECT LEVEL	DELAY LEVEL	MODULATION WAVE
WAH	AUTO SPEED	CENTER FREQUENCY	DEPTH	-	-	-	-
TREMOLO	SPEED	-	-	-	-	-	-
CHORUS	-	-	-	-	-	-	-
REVERB 1-4	DEPTH	-	-	-	-	-	-

③ Use DATA ENTRY at each Tone Group to change the parameter value.

Rotating DATA ENTRY in the clockwise direction increases the parameter value shown at the Tone Group Display; rotating it in the counter-clockwise direction decreases the parameter value. (→see “The Effector Parameters” in Chapter VI, “OTHER INFORMATION,” for the variable range of the parameters)

④ Repeat Steps ② and ③ if necessary.

NOTE: For any parameter that has a variable range of 100 steps, you can rotate DATA ENTRY while pressing the COARSE switch to increase or decrease its value 10 steps at a time.

Outline

- This function sets the Vibrato parameters for each Tone Group.
- The Vibrato parameters are set at each Tone Group for the voice chosen by the VOICE function.
- The parameter settings can be memorized for individual Tone Groups, individual Registrations, as well as individual voices. When you wish to memorize the same voice to multiple registrations, therefore, you do not need to set the parameters for each Registration.

Procedure

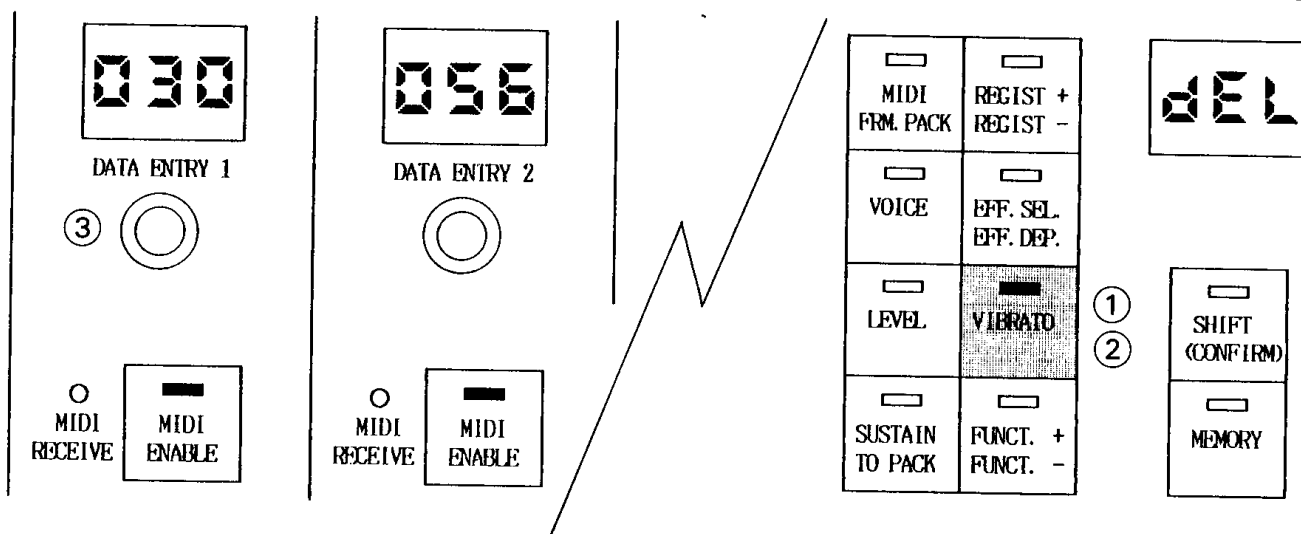

① Set [VIBRATO] to ON.

Setting the VIBRATO switch ON lets you set the Vibrato parameters for the currently selected voice of each Tone Group. The meanings of the numeric values displayed at each Display at this time are as follows:

► **Common Display:** See the "Parameter" row in the table below.

► **Tone Group Display:** The currently set Vibrato parameters for the selected voice are displayed according to the parameter displayed at the Common Display.

② Press [VIBRATO] the required number of times to select the parameter to be set.

Each time the VIBRATO switch is pressed, the parameter displayed at the Common Display is changed.

[Vibrato Parameters and Their Variable Range]

Display	DEL	SPE	DEP
Parameter	DELAY	SPEED	DEPTH
Variable range	[000] to [100]		

③ Use DATA ENTRY at each Tone Group to change the parameter value.

Rotating DATA ENTRY in the clockwise direction increases the parameter value shown at the Tone Group Display; rotating it in the counter-clockwise direction decreases the parameter value. Since the variable range for each parameter is 0-100, you can rotate DATA ENTRY while pressing the COARSE switch to increase or decrease its value 10 steps at a time.

④ Repeat Steps ② and ③ if necessary.

CAUTION: Because the Vibrato parameters are set for individual voices, different parameters cannot be concurrently set for the same Voice No. Even if you memorize different registrations with different voice parameter values, therefore, voices having the same Voice No. will always be sounded with the same Vibrato parameters.

NOTE: In default status (after a reset), the preset Vibrato parameters are set for each of the 248 Preset voices.

When the Voice Copy function is used to copy Preset voices to the User area, the default Vibrato parameters will also be copied. (The parameters set by the VIBRATO function will not be copied.)

Outline

- This function enables you to shift the sounded pitch in octave units.
- The sounded pitch is set according to the numeric value displayed at each Tone Group display.
- The Octave Shift not only can be selected for individual Tone Groups but can also be memorized to Registration Memory. By memorizing registrations with different pitches, therefore, the pitch can be changed within the same Tone Group by changing the registration.

Procedure

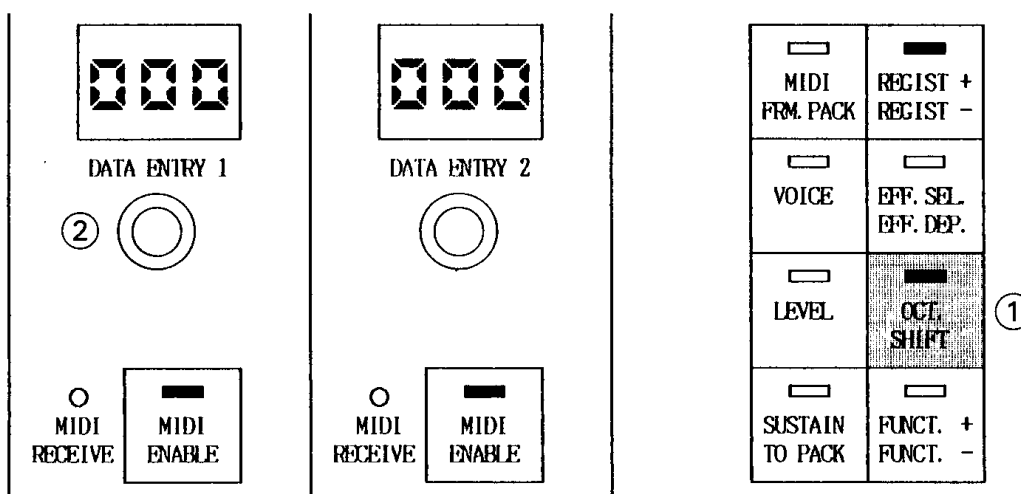

① Set [OCT. SHIFT] to ON.

Setting the OCT. SHIFT switch to ON lets you set the pitch to be shifted for each Tone Group. At this time, the currently set pitch is displayed at each Tone Group Display.

② Use DATA ENTRY at each Tone Group to set the pitch to be shifted.

Rotating DATA ENTRY in the clockwise direction changes the value in the "+" direction; rotating it in the counter-clockwise direction changes it in the "-" direction.

Tone Group Display Values	Description
[00 1]	Shift one octave higher
[000]	Standard pitch
[-0 1]	Shift one octave lower
[-02]	Shift two octaves lower

CAUTION: If shifting the pitch causes any shifted notes to exceed the soundable range of AVX-1 (A₋₁ to C₇), those notes will not be sounded.

NOTE: The Octave Shift function can also be used together with the Key Shift function (Function 8). (→see page 26)

Outline

- By using the various functions, you can perform effect or control settings, mode selection, Voice Copy, Voice Edit, and other operations.
- The function to be used is selected while observing the Function No. displayed at the Common Display.

- The quantity of functions that can be selected as well as the contents of Function 15 vary with FVX-1 and AVX-1.
- Please take careful note that some functions can be memorized to Registration Memory, some can be set for individual Tone Groups, and some can be set for the entire unit. (→see pages 7 and 51)

Procedure

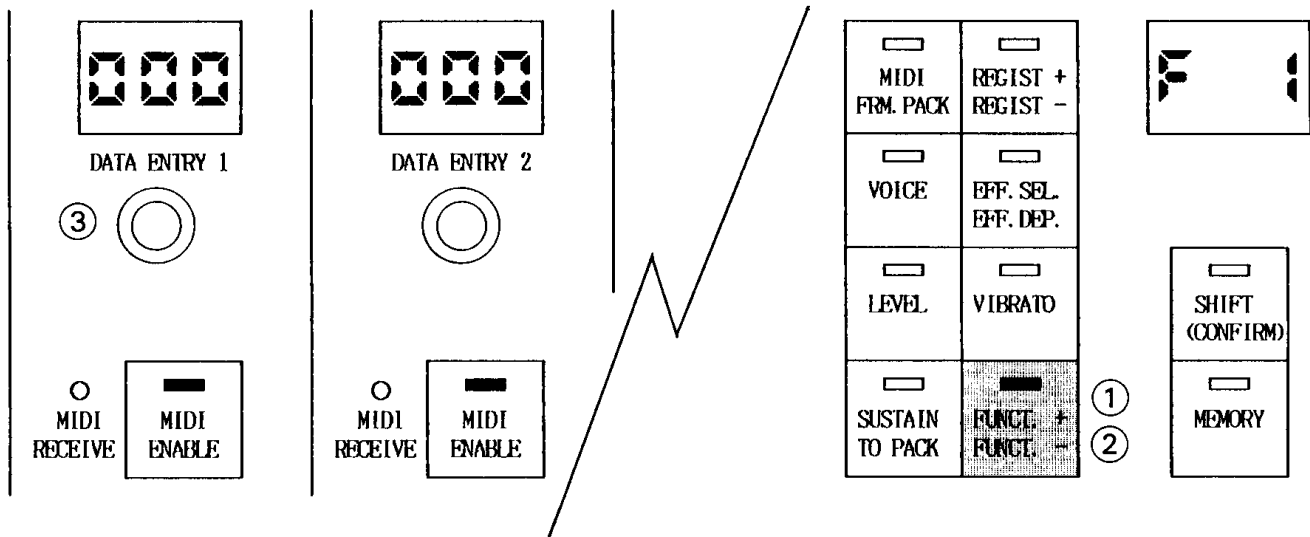

① Set [FUNCT.] to ON.

When the FUNCT. switch is set to ON, a Function No. is displayed at the Common Display so that you can perform the operation of the function corresponding to that number. See the table on the right for the correspondence between the Function Nos. and the functions.

② Press [FUNCT.] the required number of times to select the function you wish to use.

Each the FUNCT. switch is pressed, the Function No. is increased by one. While referring to the table on the right, display the number corresponding to the desired function at the Common Display.

NOTE: To move back through the Function Nos., press the FUNCT. switch while press the SHIFT switch.

③ Use DATA ENTRY at each Tone Group according to the selected function.

Rotate the DATA ENTRY according to the description under each of the functions discussed on pages 22 through 37.

[Correspondence Between the Function Nos. and the Functions]

No.	FVX-1	AVX-1
[F 1] - [F 14]	BRILLIANCE TOUCH TONE RANGE PAN MODE SELECT PAN PARAMETER SET AUX. OUT LEVEL NOTE DOUBLER DETUNE KEY SHIFT KEY LIMIT (HIGH) KEY LIMIT (LOW) REGIST. CHANGE ENABLE TUNING BULK DATA SELECT GLIDE ENABLE	
[F 15]	PITCH BEND RANGE	KEY MODE SELECT
[F 16]	VIBRATO CONTROL SELECT	-
[F 17]	VOICE COPY	-
[F 18]	VOICE EDIT	-
[F 19]	VOICE BANK SELECT	-
[F 20]	USER VOICE AREA SELECT	-

- ▶ The functions [F 1] to [F 14] are common to both FVX-1 and AVX-1.
- ▶ The [F 15] function varies for FVX-1 and AVX-1.
- ▶ The functions [F 16] to [F 20] are only used by FVX-1.

F1

BRILLIANCE (Voice Control)

Outline

- This function is used to set the brilliance of a voice.
- The permissible setting range varies for FVX-1 and AVX-1.

- Brilliance not only can be set for individual Tone Groups but can also be memorized to Registration Memory.

Procedure

- 1 Press [FUNCT.] the number of times required to display [F 1] at the Common Display.

When [F 1] is displayed at the Common Display, the currently set Brilliance value is displayed at each Tone Group Display.

- 2 Use DATA ENTRY at each Tone Group to set the Brilliance value.

Rotating DATA ENTRY in the counter-clockwise direction changes the value in the “-” direction; for FVX-1 only, rotating it in the clockwise direction changes the value in the “+” direction. [000] is the normal voice, a higher value indicates an increased brilliance and a lower value indicates an increased mellowness. The variable range that can be set for FVX-1 and AVX-1 is as follows:

- ▶ FVX-1: [- 12] to [000] to [0 12]
- ▶ AVX-1: [- 06] to [000]

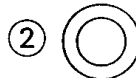
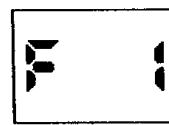
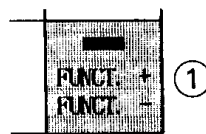

F2

TOUCH TONE RANGE (Setting the Touch Tone Control Range)

Outline

- This function lets you set the range in which Initial Touch and After Touch can be controlled.
- Certain voices are preset so that Touch Tone Control cannot be performed regardless of this setting (for example, the After Touch of attenuated voices, etc.)

- Touch Tone Range not only can be set for individual Tone Groups but can also be memorized to Registration Memory.

Procedure

- 1 Press [FUNCT.] the number of times required to display [F 2] at the Common Display.

When [F 2] is displayed at the Common Display, the currently set Touch Tone Range value is displayed at each Tone Group Display.

- 2 Use DATA ENTRY at each Tone Group to set the Range value.

Rotating DATA ENTRY in the clockwise direction changes the value in the “+” direction; rotating it in the counter-clockwise direction changes the value in the “-” direction. When this value is set to [000], touch control is disabled. The higher this value is set, the more touch control you have.

- ▶ Variable range: [- 15] to [000] to [0 15] (OFF)

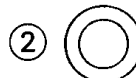
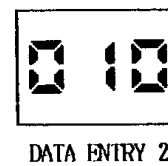
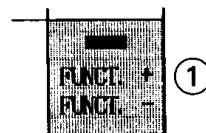

NOTE: Setting the Range value to a negative value reverses the touch effect. Consequently, the more force you apply to the keys, the smaller the volume; and the less force you apply to the keys, the greater the volume.

F3	PAN MODE SELECT (Selects the Pan Function Mode)
F4	PAN PARAMETER SET (Parameter Setting in the Selected Mode)

Outline

● Function No. 3 selects the mode of the Pan function (the function that controls the panning of the sound coming from the speakers).

● Function No. 4 sets the parameters for the selected Pan mode.

● The Pan mode and its parameters not only can be set for individual Tone Groups but can also be memorized to Registration Memory.

Procedure

① Press [FUNCT.] the number of times required to display [F 3] at the Common Display.

When [F 3] is displayed at the Common Display, the currently set Pan Mode No. value is displayed at each Tone Group Display.

② Use DATA ENTRY at each Tone Group to select the Pan mode.

Rotating DATA ENTRY in the clockwise direction changes the value in the "+" direction; rotating it in the counter-clockwise direction changes the value in the "-" direction. The correspondence between the displayed numerals and the Pan Modes, see the table below.

▶ Variable range of FVX-1: [00 1] to [00 4]

▶ Variable range of AVX-1: [00 1] to [00 3]

③ Press [FUNCT.] once more to display [F 4] at the Common Display.

When [F 4] is displayed at the Common Display, the contents of the currently set parameter of the Pan mode selected by [F 3] are displayed (excluding PRESET mode).

④ Use DATA ENTRY at each Tone Group to set the parameters.

The contents and display of the parameters as well as the variable range vary with the Pan mode. Set the parameters with reference to the table below.

CAUTION: If the EFF. SEL. function was used to select either SYMPHONIC, CELESTE, TREMOLO, CHORUS, or Reverb 1-4, the Pan function will not operate and the parameter display will become [- - -].

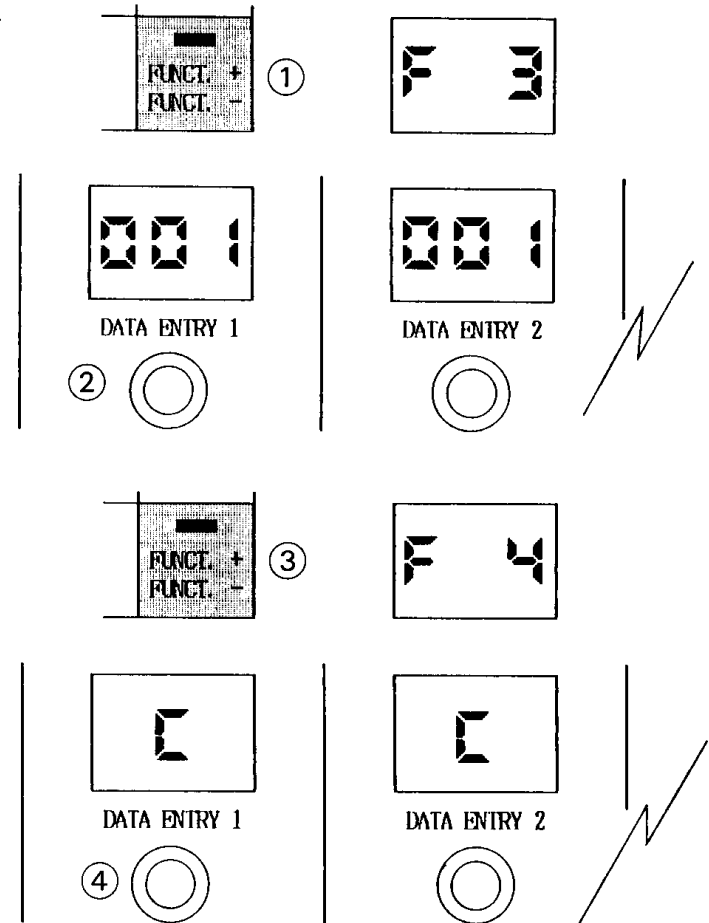

[Pan Modes and Pan Parameters]

Pan Modes (Selected by [F 3])			Pan Parameters (Selected by [F 4])	
00 1	FIXED Mode	The sound is fixed to a specific orientation for output (Monaural).	Orientation for output (7 position)	[C] : Center [J] [JJ] [JJJ] : Toward the right [LLL] [LL] [L] : Toward the left
00 2	AUTO Mode	The orientation of the output sound automatically pans from side to side.	Panning speed	[000] to [100] (The panning range is fixed to maximum for the left and right)
00 3	MANUAL Mode	The orientation of the output sound is controlled manually. (The panning range that can be controlled is fixed to maximum for the left and right)	Operating element under control (MIDI signal)	[C - 1] : Modulation Wheel [C - 2] : Second Expression Pedal [C - 3] : Pitch Wheel [C - 4] : Pan (MIDI Control Change)
00 4	PRESET Mode (FVX-1 only)	Each voice is output at its preset orientation (Stereo).	None	[- - -]

NOTE: In default status (after a reset), the FIXED mode is set and the sound is output monaurally to the center position. To perform output using the stereo panning that is preset for each voice of FVX-1, select Pan Mode No. 4 (PRESET mode). (→see page 44 to 47)

F5

AUX. OUT LEVEL (Sets the Output Level from AUX. OUT)

Outline

- This function allows you to set the output level for each Tone Group from the AUX. OUT jacks.
- The AUX. OUT level not only can be set for individual Tone Groups but can also be memorized to Registration Memory.

- For details on its relationship with other level control and when this function should be set, see I-7, "Volume Level Control," on page 10.

Procedure

- 1 Press [FUNCT.] the number of times required to display [F 5] at the Common Display.

When [F 5] is displayed at the Common Display, the currently set Level value is displayed at each Tone Group Display.

- 2 Use DATA ENTRY at each Tone Group to set the Level value.

Rotating DATA ENTRY in the clockwise direction increases the displayed value and the volume level; rotating it in the counter-clockwise direction decreases the displayed value and the volume level.

- Variable range: 25 steps from [000] to [024]
(OFF) (Maximum)

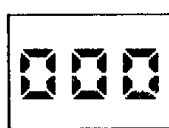
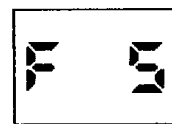
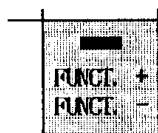

DATA ENTRY 1



DATA ENTRY 2



F6

NOTE DOUBLER (Sets the Note Doubler Function)

Outline

- This function automatically adds one note of an arbitrary pitch to the notes received by MIDI.
- The pitch of the doubled notes can be set in half-steps within a maximum three-octave range above and below the original note.

- The Note Doubler function not only can be set for individual Tone Groups but can also be memorized to Registration Memory.

Procedure

- 1 Press [FUNCT.] the number of times required to display [F 6] at the Common Display.

When [F 6] is displayed at the Common Display, the currently set Note Doubler pitch is displayed at each Tone Group Display as a numeric value.

- 2 Use DATA ENTRY at each Tone Group to set the Note Doubler pitch.

Rotating DATA ENTRY in the clockwise direction changes the value in the "+" direction and raises the pitch in half-steps; rotating it in the counter-clockwise direction changes the value in the "-" direction and lowers the pitch in half-steps.

- Variable range: [-36] to [000] to [036]
(3 octaves below) (OFF) (3 octaves above)

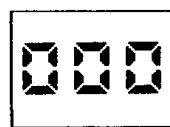

DATA ENTRY 1

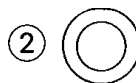

DATA ENTRY 2



NOTE: If the sounded range of any doubled notes exceeds the permissible range of the unit (A₋₁ to C₇), those doubled notes will not be sounded.

F7

DETUNE (Pitch Adjustment for Each Tone Group)

Outline

- This function changes the pitch of the Tone Groups to produce a detuning effect.
- The permissible setting range and the change in pitch per step vary with FVX-1 and AVX-1.
- Detuning (pitch) not only can be set for individual Tone Groups but can also be memorized to Registration Memory.

Procedure

① Press [FUNCT.] the number of times required to display [F 7] at the Common Display.

When [F 7] is displayed at the Common Display, the currently set pitch is displayed at each Tone Group Display as a numeric value.

② Use DATA ENTRY at each Tone Group to set the pitch.

Rotating DATA ENTRY in the clockwise direction changes the value one step at a time in the "+" direction; rotating it in the counter-clockwise direction changes the value one step at a time in the "-" direction.

	Variable Range	1 Step
FVX-1	[- 15] to [000] to [0 15]	1.2 cents
AVX-1	[- 05] to [000] to [005]	3.0 cents

(100 cents=1 half-step)

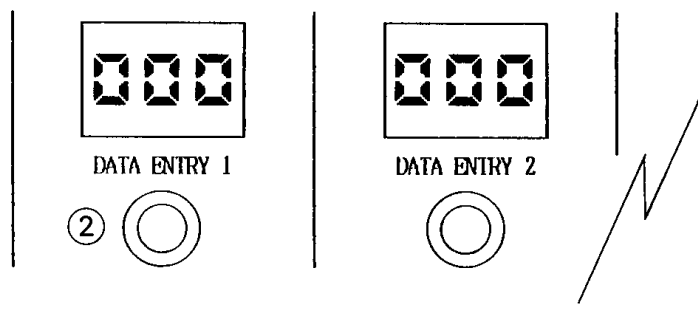
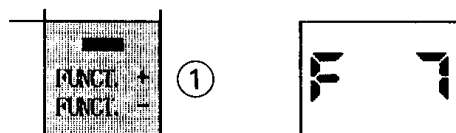

F8

KEY SHIFT (Transposes the Key of Each Tone Group)

Outline

- This function permits the key of each Tone Group to be shifted in half-steps.
- The key can be shifted within a maximum one-octave range above and below the original key.
- The Key Shift function not only can be set for individual Tone Groups but can also be memorized to Registration Memory.

Procedure

① Press [FUNCT.] the number of times required to display [F 8] at the Common Display.

When [F 8] is displayed at the Common Display, the number of steps that the key is currently shifted is displayed at each Tone Group Display.

② Use DATA ENTRY at each Tone Group to set the pitch.

Rotating DATA ENTRY in the clockwise direction changes the value in the "+" direction and raises the pitch in half-steps; rotating it in the counter-clockwise direction changes the value in the "-" direction and lowers the pitch in half-steps.

▶ Variable range: [- 12] to [000] to [0 12]
 (1 octave below) (OFF) (1 octave above)

CAUTION: If shifting the key causes any shifted notes to exceed the soundable range of the unit (A₋₁ to C₇), those notes will not be sounded.

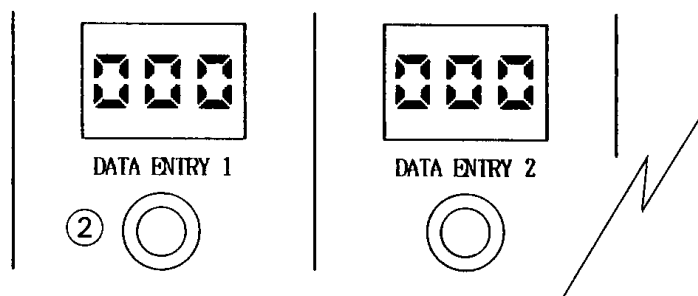
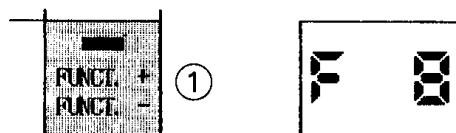

F9	KEY LIMIT [HIGH] (Sets the Upper Limit of the Receivable Range)
F10	KEY LIMIT [LOW] (Sets the Lower Limit of the Receivable Range)

Outline

- These functions let you set the range of the notes that can be received by the unit in half-step units. Function No. 9 sets its upper limit, and Function No. 10 sets the lower limit.
- The Key Limit setting can be performed for individual Tone Groups but cannot be memorized to Registration Memory.

- Because the Key Limit functions set the range (the Note No. range) that will be received by MIDI, its setting usually equals the setting of the range that will be sounded. (If Key Shift or Octave Shift (AVX-1 only) has been used to shift the pitch, the range set by Key Limit will be shifted accordingly, such that the range set by Key Limit does not equal the actual range that is sounded.)

Procedure

- 1 Press [FUNCT.] the number of times required to display [F 9] at the Common Display.

When [F 9] is displayed at the Common Display, the currently set upper limit of the receivable range is displayed at each Tone Group Display as a note name. The highest-limit note name is [C 7].

- 2 Use DATA ENTRY at each Tone Group to set the upper-limit note name.

Rotating DATA ENTRY in the counter-clockwise direction lowers the note name in half-steps, so display the note name you wish to set as the upper limit of the receivable range.

► Variable range: [A _ 1] to [C 7] (Maximum)

NOTE: This value cannot be lower than the lower-limit note name set using the Key Limit [Low] function.

- 3 Press [FUNCT.] once more to display [F 10] at the Common Display.

When [F 10] is displayed at the Common Display, the currently set lower limit of the receivable range is displayed at each Tone Group Display as a note name. The lowest-limit note name is [A _ 1].

- 4 Use DATA ENTRY at each Tone Group to set the lower-limit note name.

Rotating DATA ENTRY in the clockwise direction raises the note name in half-steps, so display the note name you wish to set as the lower limit of the receivable range.

► Variable range: [A _ 1] (Minimum) to [C 7]

NOTE: This value cannot be higher than the upper-limit note name set using the Key Limit [High] function.

[Correspondence Between the Display (1st Two Columns) and the Note Names]

- For whole notes (white keys), the first column shows the note name and the second column is blank.
- For half-notes (black keys), the first column shows the note name and the second column shows [#] (#).

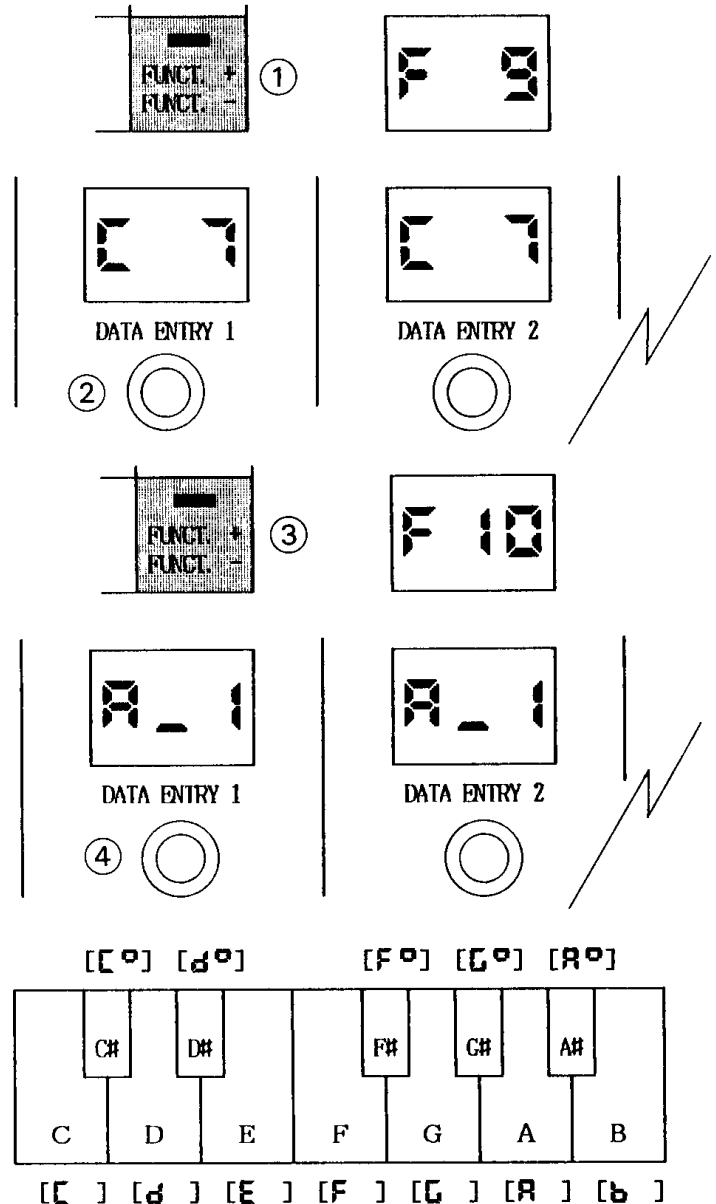

[A Sample Receivable Range] (When the upper limit is set C₅ and the lower limit is set to C₂)

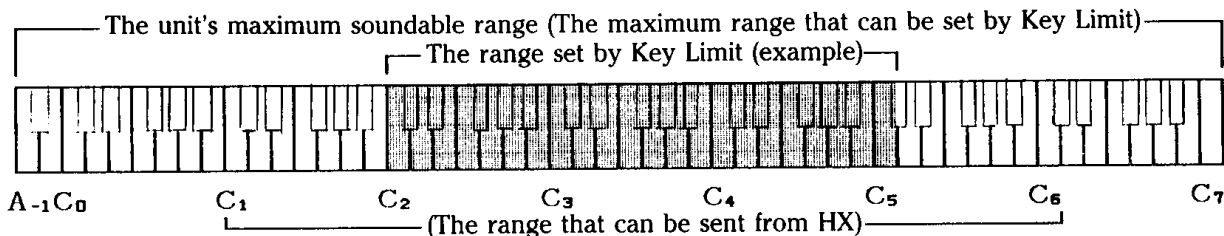

F11

REGIST. CHANGE ENABLE (Enables/Disables a Registration Change)

Outline

- This function lets you enable or disable the changing of registrations.
- The Regist. Change Enable/Disable (ON/OFF) status is controlled by receiving a Program Change that is sent from an external device.
- When a Regist. Change signal is received, the registration is changed at each enabled (ON) Tone Group but does not change at the disabled (OFF) Tone Groups.
- Regist. Change Enable can be set for individual Tone Groups but cannot be memorized to Registration Memory.

Procedure

- 1 Press [FUNCT.] the number of times required to display [F 1 1] at the Common Display.

When [F 1 1] is displayed at the Common Display, the currently selected Regist. Change status is displayed at each Tone Group Display.

- 2 Use DATA ENTRY at each Tone Group to select the Regist. Change status.

Rotating DATA ENTRY in the counter-clockwise direction changes the display to [0 F F] (Disable); rotating it in the clockwise direction returns it to [0 0 0] (Enable).

► Variable range: [0 0 0] or [0 F F]
(Enable) (Disable)

NOTE: When Regist. Change is disabled for a specific Tone Group then a Regist. Change signal is received, the Common Display shows [. d u] (individual) to indicate that the Registration Nos. of all Tone Groups do not match.

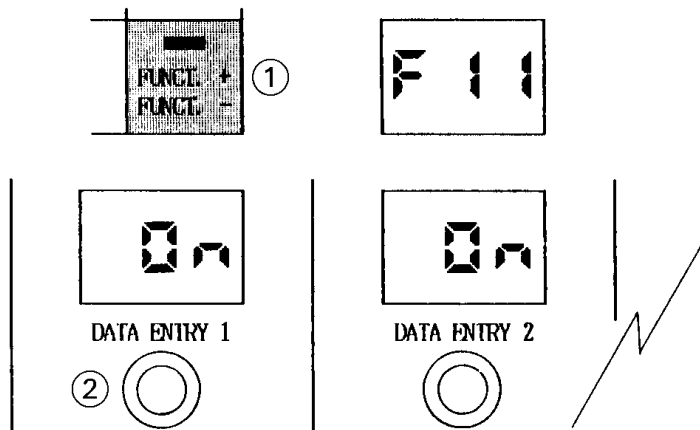

F12

TUNING (Adjusts the Overall Pitch of the Unit)

Outline

- This function allows fine adjustment of the overall pitch of the unit.
- The permissible setting range and the change in pitch per step varies for FVX-1 and AVX-1. (Both are set based on a frequency of A₃).
- Because the Tuning function sets the overall pitch of the unit, the Tuning value cannot be memorized for only a single Tone Group or Registration. The overall pitch setting is backed up by the unit and is transferred as a part of Bulk data, but is not transferred to a RAM Pack.

Procedure

- 1 Press [FUNCT.] the number of times required to display [F 1 2] at the Common Display.

When [F 1 2] is displayed at the Common Display, the currently set pitch value is displayed as a numerical value (a frequency of A₃) at the Displays of Tone Groups 3 and 4 (or of Tone Groups 1 and 2 for AVX-1).

- 2 Use DATA ENTRY at the rightmost Tone Group to set the pitch.

Rotating DATA ENTRY of Tone Group 4 (or of Tone Group 2 for AVX-1) in the clockwise direction increases the value and raises the pitch; rotating it in the counter-clockwise direction decreases the value and lowers the pitch. Note that the variable range that can be set for FVX-1 and AVX-1 conforms to the table below.

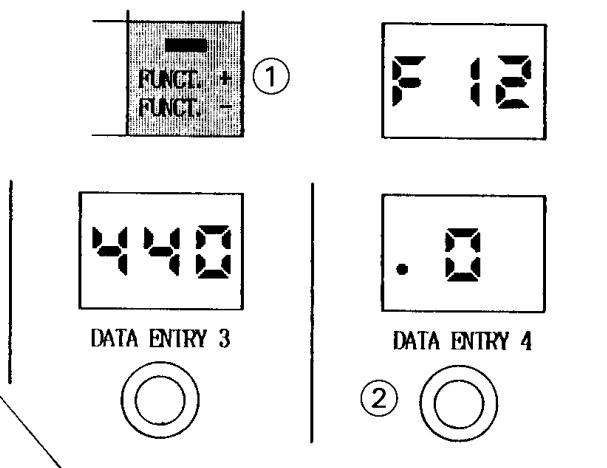

	Variable Range	1 Step
FVX-1	[433.6] (-21 steps) to [440.0] (Standard) to [446.4] (+21 steps)	0.3/0.4 Hz
AVX-1	[433.6] (-9 steps) to [440.0] (Standard) to [446.4] (+9 steps)	0.6/0.9/0.4 Hz

F13

BULK DATA SELECT (Selects the Bulk Data to be Sent)

Outline

- This function allows you to select the Bulk data to be sent to an external device (MDX-1, MDR-2P, etc.).
- The Bulk data is sent when a "Request-to-Send All RAM Data" code is received from an external device.
- Under normal use, this function may be left set to [ALL] (the default).
- The setting by this function applies to the entire unit.

Procedure

- 1 Press [FUNCT.] the number of times required to display [F { 3 }] at the Common Display.

When [F { 3 }] is displayed at the Common Display, the contents of the currently selected Send data are displayed at the Tone Group 4 Display (or the Tone Group 2 Display for AVX-1). (See the table below.)

- 2 Use DATA ENTRY at the rightmost Tone Group to select the data.

Each time DATA ENTRY of Tone Group 4 (or Tone Group 2 for AVX-1) is rotated in the clockwise direction, the display is changed. The contents of the Display and the Bulk data are as follows:

ALL (ALL)	The three data types below plus all the data memorized at the unit (excluding User Voice data)
REG (Regist)	Data of Registration Memory 1 to 16
VOIC (Voice)	Data of the Common User voices (FVX-1)
EFF (Effector)	Data of the Program Effectors 1 to 4

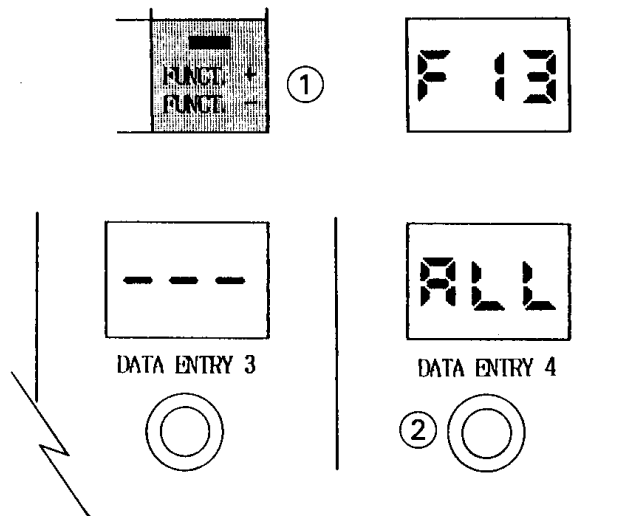

F14

GLIDE ENABLE (Enables/Disables the Glide Function)

Outline

- This function enables or disables the Glide effect for each Tone Group.
- The Glide Enable/Disable (ON/OFF) status is controlled by receiving a Foot Switch Left signal (Exclusive Message) from an external device. This signal is always received regardless of the MIDI receiving channel specification.
- When a Foot Switch Left signal is received, the Glide effect is applied at the enabled (ON) Tone Groups but does not operate at disabled (OFF) Tone Groups.
- The Glide status not only can be set for individual Tone Groups but can also be memorized to Registration Memory.

Procedure

- 1 Press [FUNCT.] the number of times required to display [F { 4 }] at the Common Display.

When [F { 4 }] is displayed at the Common Display, the currently set Glide status is displayed at each Tone Group Display.

- 2 Use DATA ENTRY at each Tone Group to set the Glide status.

Rotating DATA ENTRY in the counter-clockwise direction changes the display to [ON] (Enable); rotating it in the counter-clockwise direction returns it to [OFF] (Disable).

- ▶ Variable range: [OFF] or [ON]
(Disable) (Enable)

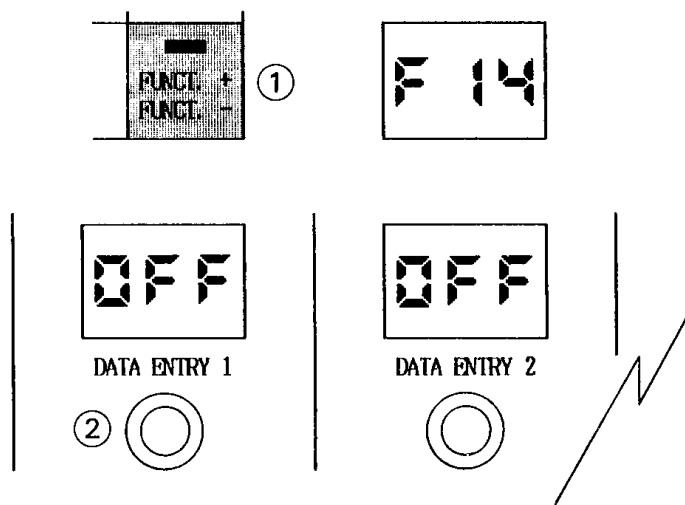

Outline

- This function sets the Sounded Key mode of AVX-1 to either 8-note polyphonic/2 Tone Group mode or to 16-note polyphonic/1 Tone Group mode.
- If the 16-note polyphonic/1 Tone Group mode is selected, the voice of only Tone Group 1 is sounded.
- The Sounded Key mode is set for the entire unit and cannot be memorized to Registration Memory.

Procedure

① Press [FUNCT.] the number of times required to display [F 15] at the Common Display.

When [F 15] is displayed at the Common Display, the currently set Sounded Key mode is displayed at the Displays of Tone Groups 1 and 2.

② Use DATA ENTRY at Tone Group 2 to select the Sounded Key mode.

Rotating DATA ENTRY in the clockwise direction selects the 16-note/1 Tone Group mode; rotating it in the counter-clockwise direction selects the 8-note/2 Tone Group mode.

Key Mode	Tone Group Display 1	Tone Group Display 2
8-note/2 Tone Group	[8]	[8]
16-note/1 Tone Group	[15]	[0]

NOTE: When the 16-note/1 Tone Group mode is selected, the various other settings will only be valid for Tone Group 1. It will be impossible to control Tone Group 2 and if you attempt to set the voice or level, its Tone Group Display will show [- - -].

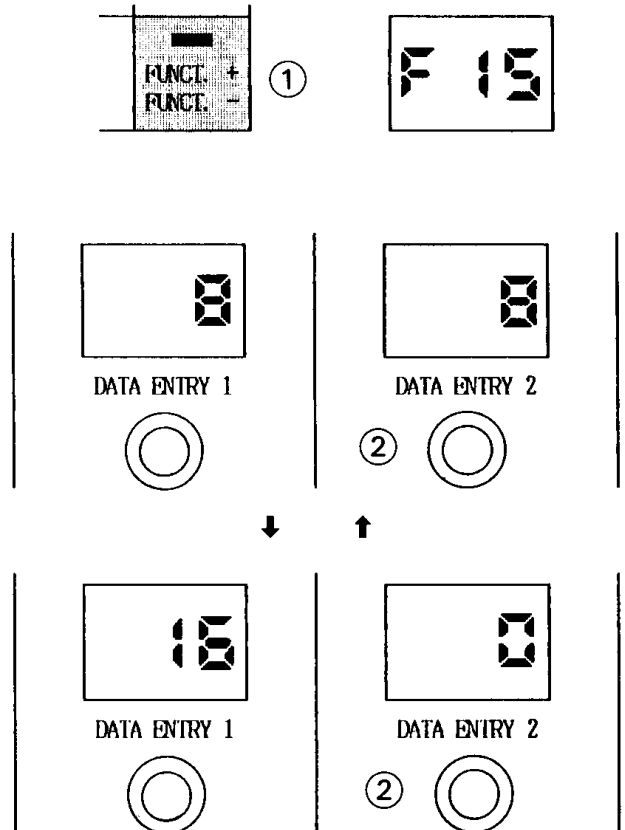

F15 PITCH BEND RANGE (Sets the Range of Pitch Bend Control) [FVX-1]

Outline

- This function lets you set the range of pitch bend control (the maximum range in which the pitch can slide up and down) for each Tone Group.
- Pitch Bend is controlled by receiving a Pitch Bender signal that is sent from an external device.
- When the Pitch Bender signal is received, the pitch is "bent" within the range set by this function.
- The Pitch Bend Range not only can be set for individual Tone Groups but can also be memorized to Registration Memory.

Procedure

- 1 Press [FUNCT.] the number of times required to display [F 15] at the Common Display.

When [F 15] is displayed at the Common Display, the currently set range is displayed at each Tone Group Display as a numeric value.

- 2 Use DATA ENTRY at each Tone Group to set the Range value.

Rotating DATA ENTRY in the clockwise direction increases the value and expands the range in half-steps; rotating it in the counter-clockwise direction decreases the value and narrows the range in half-steps.

▶ Variable range: [000] to [0 12]
(OFF) (1 octave)

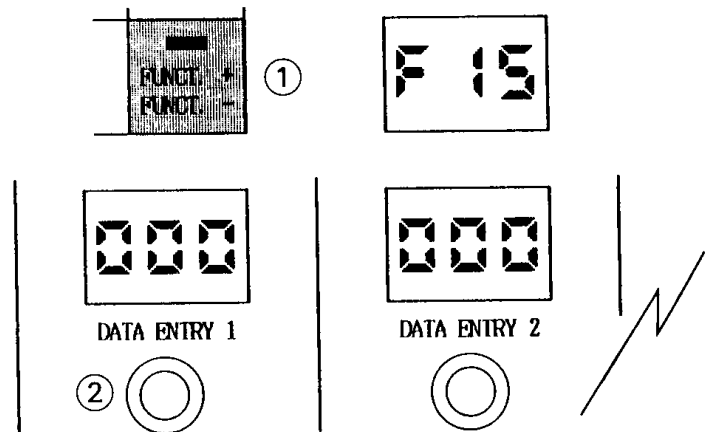

F16 VIBRATO CONTROL SELECT (Selects the Vibrato Controller) [FVX-1]

Outline

- When you wish to manually control the Vibrato Depth, this function selects the controller used for each Tone Group.
- If this function is set to OFF for any Tone Group, Vibrato will be applied to that Tone Group according to the [VIBRATO] setting. (→see page 19)
- Vibrato Control not only can be selected for individual Tone Groups but can also be memorized to Registration Memory.

Procedure

- 1 Press [FUNCT.] the number of times required to display [F 15] at the Common Display.

When [F 15] is displayed at the Common Display, the currently set Controller No. (or "OFF" status) is displayed at each Tone Group Display.

- 2 Use DATA ENTRY at each Tone Group to set the Controller No. value.

Each time DATA ENTRY is rotated, the Display is changed. The displayed Controller Nos. and their corresponding controllers are as follows:

OFF	Vibrato is applied according to the (VIBRATO) setting
c - 1	Controlled by the Modulation Wheel
c - 2	Controlled by After Touch on the keys
c - 3	Controlled by Breath Controller signals

NOTE: If you wish to control Vibrato using a Breath Controller that is connected to HX, set this function to [c - 3].

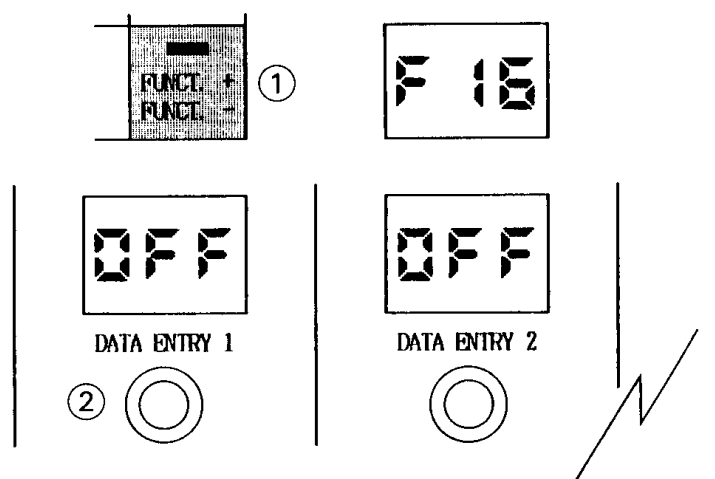

NOTE: These controllers can only control the Vibrato Depth. The maximum controllable value is the Depth value that is set by [VIBRATO]. Note that Vibrato will not operate if the Depth setting is "0".

Outline

- This function copies any of the 248 Preset voices and 248 User voices to any Voice Nos. in the User Area (248 User Voice Nos. 1-248 and Common User Voice Nos. 1-8).
- To edit any of the 248 Preset voices, this function must first be used to copy the Preset voice to be edited into the User Area. (→see page 32)
- The area of Common User Voice Nos. 1-8, which is shared by Voice Banks A and B, is provided to let you register voices in the order of their frequency of use. If you wish to register up to eight of the 248 Preset voices or 248 User voices in this area, use Voice Copy.
- The Voice Copy function applies to the entire unit, regardless of the individual settings performed for each Tone Group.

Procedure

① Press [FUNCT.] the number of times required to display [F 17] at the Common Display.

When [F 17] is displayed at the Common Display, the Displays of Tone Groups 1, 2, and 4 change as shown below so that Voice Copy can be performed.

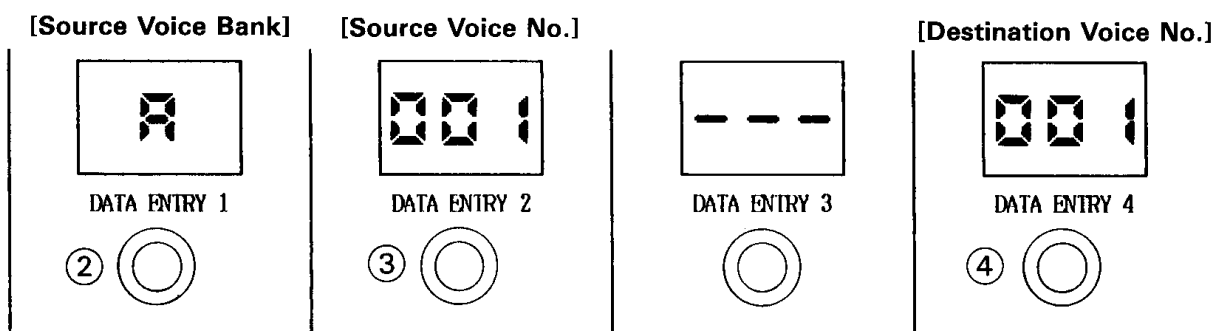

② Use DATA ENTRY at Tone Group 1 to select the source Voice Bank.

Rotating DATA ENTRY in the clockwise or counter-clockwise direction changes the Display as follows:

- ▶ [A]: Selects Voice Bank A (Preset Area)
- ▶ [b]: Selects Voice Bank B (User Area)

Voice Bank A	248 Preset voices	8 Common User voices
Voice Bank B	248 User voices	

③ Use DATA ENTRY at Tone Group 2 to select the source Voice No.

Rotating DATA ENTRY in the clockwise direction increases the Voice No.; rotating it in the counter-clockwise direction decreases the Voice No.

- ▶ [00 1] to [248]: Selects one of the 248 Preset voices or one of the 248 User voices, depending on the Voice Bank selected at Tone Group 1.
- ▶ [00 1] to [008]: Selects one of the 8 Common User voices.

NOTE: In default status (after a reset), the 248 Preset voices are copied to the area of the 248 User voices, so the voices in Voice Banks A and B are exactly the same.

④ Use DATA ENTRY at Tone Group 4 to select the destination Voice No.

Rotating DATA ENTRY in the clockwise direction increases the Voice No.; rotating it in the counter-clockwise direction decreases the Voice No.

- ▶ [00 1] to [248]: Selects copying to the area of User Voices 1-248 in Voice Bank B.
- ▶ [00 1] to [008]: Selects copying to the area of Common User voices 1-8.

CAUTION: When Voice Copy is performed, the Voice data of the destination Voice No. selected at Tone Group 4 is replaced by the data of the source Voice No. Before executing Voice Copy, make sure you are selecting the correct destination Voice. No.

NOTE: If you also press the COARSE switch while using DATA ENTRY to select a Voice No. at Tone Group 2 or 4, the Voice No. can be increased (or decreased) 10 steps at a time.

⑤ Press [MEMORY] to copy the voice.

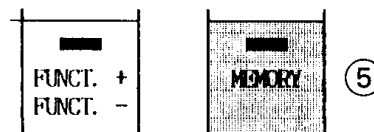

The MEMORY lamp lights up when the voice selected at Tone Groups 1 and 2 has been copied to the User Area Voice No. selected at Tone Group 4. Repeat Steps ② to ⑤ to copy more voices if necessary.

NOTE: When a Preset voice is copied, its default Vibrato parameters also will be copied.

Outline

- This function edits the data of Voice parameters then registers the edited voice as a User voice.
- Voice Edit is performed by calling a voice from the User Area. To edit a Preset voice, therefore, the voice must be copied to the User Area first, then called for editing. (→see page 31)
- 11 voice parameters can be edited with respect to eight operators.
- The Voice Edit operation involves the use of the DATA ENTRY switches of all Tone Groups, but applies to the entire unit regardless of the individual settings at each Tone Group.

Procedure

① Set Tone Group 1 to the status in which where notes can be sounded.

Voice Edit is performed by calling a voice to Tone Group 1. You can check the voice being edited by sounding its note. Set Tone Group 1 so that notes can be sounded by setting [MIDI ENABLE] to ON, setting the MIDI receiving channel, the volume level, etc. (→see pages 12, 13, and 15)

NOTE: Because the voice to be edited is specified after entering EDIT mode, the voice selected by [VOICE] can be any voice. Also, either Voice Bank A or B can be selected.

② Copy the voice as is to the destination Voice No. of registration.

Voice Edit is performed by calling a voice from the User Area (Voice Bank B), then registering the edited voice to the same No. used for calling the voice. When editing a Preset voice, first copy the Preset voice to the destination Voice No. in the User Area. (→see page 31)

NOTE: In default status (after a reset), the 248 Preset voices are copied to the 248 User Voices in the User Area. After an edited voice has been registered to a temporary Voice No., therefore, that voice may be copied to any No.

③ Press [FUNCT.] the number of times required to display [F 18] at the Common Display.

When [F 18] is displayed at the Common Display, [E d] (Edit) is shown at the Tone Group 1 Display.



④ Use DATA ENTRY at Tone Group 1 to select the voice to be edited.

Rotating DATA ENTRY in the clockwise direction increases the Voice No.; rotating it in the counter-clockwise direction decreases the Voice No.

▶ [00 1] to [248]: Selects one of the 248 Preset voices (Voice Bank B).

▶ [00 1] to [008]: Selects one of the 8 Common User voices.



NOTE: If you also press the COARSE switch while using DATA ENTRY to select a Voice No., the Voice No. can be increased (or decreased) 10 steps at a time.

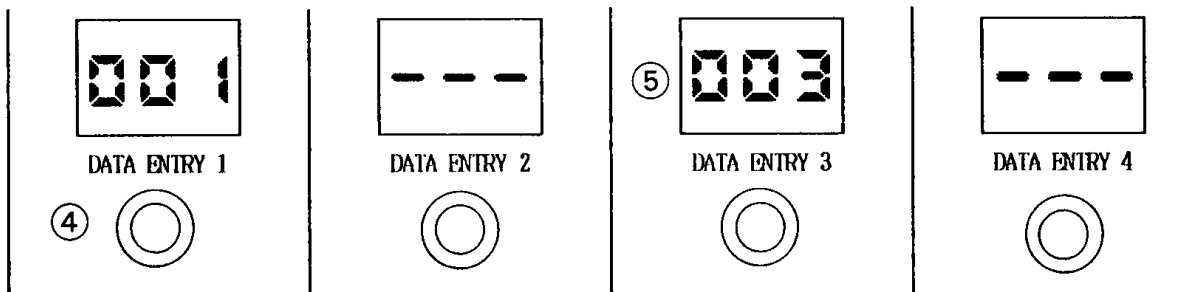

⑤ Check the algorithm of the voice to be edited at the Display of Tone Group 3.

When the voice to be edited is selected, its Algorithm No. is shown at the Tone Group 3 Display. Before editing, make sure to check the algorithm of the voice to be edited by comparing the displayed No. with the Nos. listed in "The Algorithm Patterns" in Chapter VI, "OTHER INFORMATION."

▶ [000] to [063]: An Algorithm No. is displayed based on the selected voice.

NOTE: An algorithm is the pattern of the operators (which are the units used by the FM Tone Generator to create voices). The Preset Voices of FVX-1 are created by combining eight operators, and their algorithms allow you to check the function of each operator.

NOTE: The Algorithm Nos. range up No. 63, but the Preset Voices do not use all of these algorithms. Note that the display of No. 0 indicates an algorithm other than Nos. 1 to 63 and will not be displayed when editing the Preset Voices.

⑥ Use DATA ENTRY at Tone Group 3 to select the parameter.

After checking the algorithm, use DATA ENTRY of Tone Group 3 to select the Voice parameters to be edited. The Voice parameters which can be edited are listed in the table below. Rotating DATA ENTRY in the clockwise direction moves the parameter display down through the table; rotating it in the counter-clockwise direction moves the parameter display up through the table.

NOTE: When a parameter is selected at Tone Group 3, the Operator No. (or Operator Group) is shown at the Tone Group 2 Display, and the parameter value is shown at the Tone Group 4 Display.

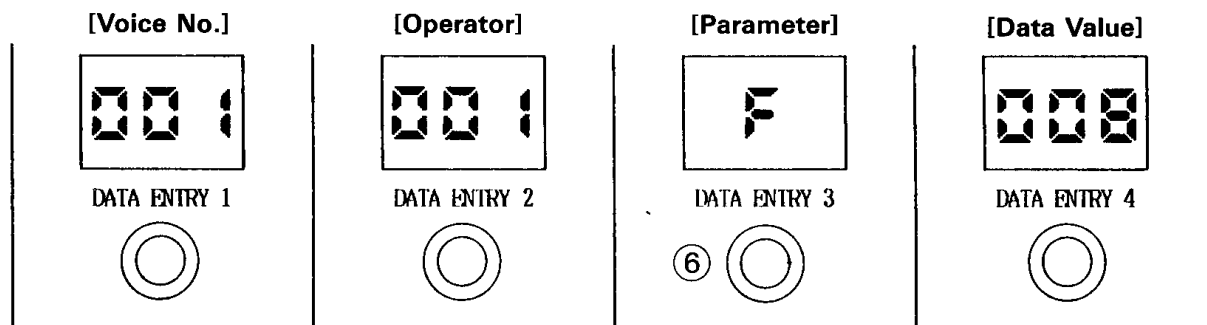

[Parameters That Can be Edited and Their Display]

Display	Parameter Name	Description	
[F]	FEET	Highest pitch (frequency) of the output sound. Can be set to 4 steps in octave units for the operator groups (8-5 and 4-1).	
[UF]	WAVE FORM	The basic waveform that is read by the operator. One of eight waveform types, such as sine waves, etc., can be set for each operator.	
[OL]	OUTPUT LEVEL	The maximum output level of the operator.	
[RT]	ENVELOPE GENERATOR	ATTACK RATE	The speed at which the output level rises from Level 0 to Attack Level.
[RL]		ATTACK LEVEL	The output level after the attack at which decay begins.
[d1]		DECAY 1 RATE	The speed at which the output level drops from Attack Level to Decay 1 Level.
[d1L]		DECAY 1 LEVEL	An Intermediate level which can be set between the Attack Level and Decay 2 Level.
[d2]		DECAY 2 RATE	The speed at which the output level drops from Decay 1 Level to Decay 2 Level.
[d2L]		DECAY 2 LEVEL	The level at which sustaining of the note is begun.
[r]		RELEASE RATE	The speed at which the output level reaches Release Level after the key is release.
[rL]		RELEASE LEVEL	The final level after the key is released. (Usually set to "0")

NOTE: The Feet parameter is usually set to 8' which is standard pitch, but can be changed to 32', 16' or 4' if necessary. This parameter can only be changed, however, in group units for Operators 8-5 and Operators 4-1.

NOTE: The Waveform parameter is usually set to sine waves, but the waveform can be changed if necessary. See the figure on page 36 for the waveforms that can be set.

NOTE: The Output Level parameter sets the maximum level that the operator can output. The four levels of the Envelope Generator are the levels which can be set when this Output Level has been set to 100.

NOTE: The Envelope Generator parameters set the fluctuations in the output level over time. It is generally set as shown in the figure on the right.

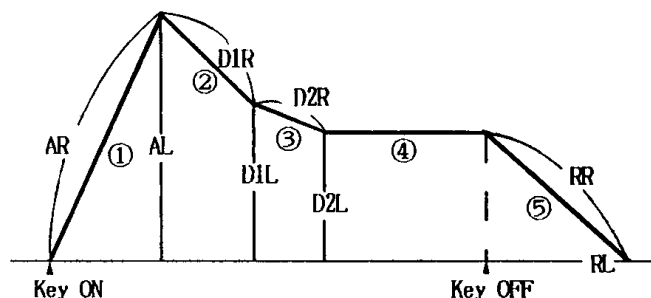

① When the key is pressed, the output level reaches the Attack Level at the speed set by the Attack Rate; ② it next reaches Decay 1 Level at the speed set by the Decay 1 Rate; ③ then reaches Decay 2 Level at the speed set by the Decay 2 Rate. ④ While the key is being pressed, the output level is held at the Decay 2 Level; ⑤ when the key is released, the output level reaches the Release Level (0) at the speed set by the Release Rate.

⑦ Use DATA ENTRY of Tone Group 2 to select the operator.

After selecting the parameter, use DATA ENTRY of Tone Group 2 to select the operator to be edited. Be sure to select the operator while checking the function of each operator according to the algorithm. Rotating DATA ENTRY in the clockwise direction increase the Operator No.; rotating it in the counter-clockwise direction decreases the Operator No. The Operator Nos. that can be selected are listed below; note that the Display and variable range differ only when the Feet parameter is selected.

► When Feet is selected: [00 1] (Operators 8-5)
[00 2] (Operators 4-1)

► When Feet is not selected: [0F 1] to [0F 8]

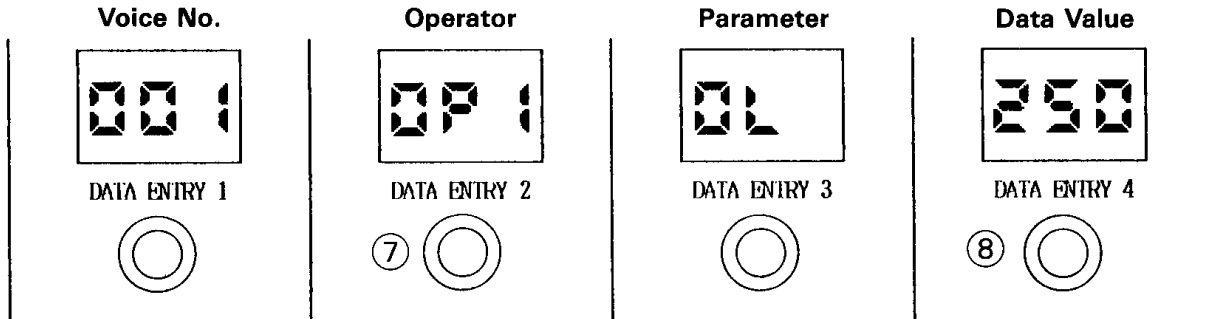

(This figure illustrates the selection of Output Level)

[Reference: Modulators and Carriers]

Based on the function of an operator, that operator can be broadly grouped as a modulator or carrier.

► **Modulator:** An operator that outputs Modulation signals to other operators. (A of Fig. 1)

► **Carrier:** An operator that outputs Audio signals (the signals of the actual voice). (B of Fig. 1)

Also, certain operators are subjected to feedback (C of Fig. 2).

The pattern in which the operators is arranged determines whether each operator is a modulator or a carrier. This pattern is called an "algorithm." Using Algorithm No. 4 (Fig. 3) as an example, Operator 6 is modulated by Operator 8 (which is subjected to feedback) and Operator 7, both of which are modulators. The modulated Operator 6 (which is also a modulator) modulates Operator 5 which is a carrier, and Operator 5 outputs the actual sound. This same operator is being carried out by Operators 4-1, and the sound output from Operators 5 and 1 is mixed to form one voice.

► Even within the same parameter, the element to be changed will vary according to whether the selected operator is a modulator or a carrier. (→see the next page)

► The data (level, frequency, feedback, etc.) to be set for each operator also varies. Even if the data values are changed in the same way, therefore, the change in the voice will vary according to the operator.

⑧ Use DATA ENTRY at Tone Group 4 to change the data value.

When the parameter and operator(s) to be edited are selected, the currently set parameters of that operator are shown at the Tone Group 4 Display. While producing notes to check the sound, use DATA ENTRY to increase or decrease the data value. Rotating it in the clockwise direction increases the value one at a time; rotating it in the counter-clockwise decreases it one at a time (except when Feet is selected). The variable range of the parameter data is as follows:

► Feet: [03 2] [0 1 6] [00 8] [00 4]

► Waveform: [00 0] to [00 7]

► Output Level: [00 0] to [2 5 5]

► Envelope Generator: [00 0] to [1 0 0]

(Fig. 1)

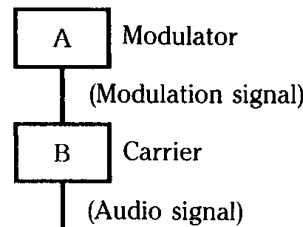

(Fig. 2)

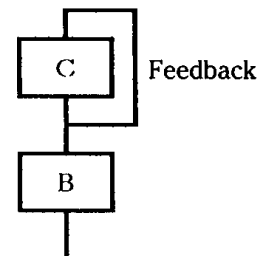

(Fig. 3: Algorithm No. 4)

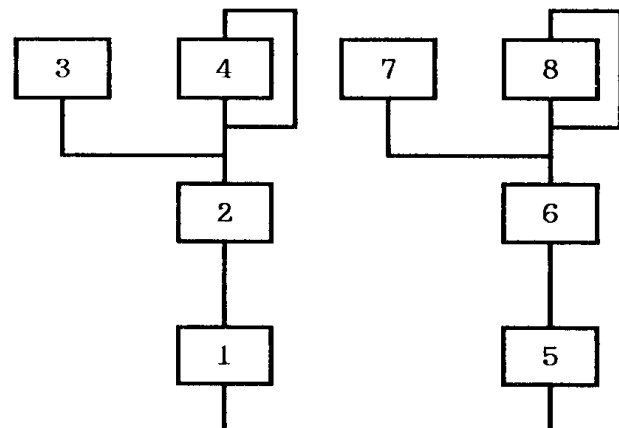

⑨ If necessary, repeat Steps ⑥, ⑦, and ⑧.
 If you wish to change only specific parameters for each operator, repeat the steps in the sequence of: ⑥⑦⑧ → ⑦⑧. If you wish to change the parameters of a specific operator, repeat the steps in the sequence of: ⑦⑧⑧ → ⑥⑧.

CAUTION: If any of the selector switches in the Common section are pressed during editing, the EDIT mode will be cancelled and the data being edited will be erased. Unless you have registered the edited voice and wish to proceed to another function, be careful not to press the selector switches.

[Changes Resulting from Changing the Data Values]

Parameter		Modulator	Carrier
Feet		When the Feet value is changed, the change in the voice will vary with the voice's algorithm and the settings of the various parameters. Perform editing while actually listening to its sound.	
Waveform		When the Waveform is changed, the change in the voice will vary with voice's algorithm and the settings of the various parameters. Perform editing while actually listening to its sound.	
Output Level		The timbre generally changes, becoming brighter as the value increases or mellower as the value decreases	The volume generally changes, increasing as the value increases or decreasing as the value decreases.
Envelope Generator	Rate	The speed at which the timbre fluctuates generally changes, becoming faster as the value increases or slower as the value decreases.	The speed at which the volume fluctuates generally changes, becoming faster as the value increases or slower as the value decreases.
	Level	The timbre generally fluctuates at each level, becoming brighter as the value is increased or mellower as the value is decreased.	The volume generally fluctuates at each level, increasing as the value increases or decreasing as the value decreases.

NOTE: Regarding the Output Level settings, the following generalizations may be stated:

- ▶ When the output level of a modulator is raised, the voice becomes brighter and more showy; but if raised too much, the voice becomes noisy.
- ▶ For modulators that are subjected to feedback, fluctuations in the timbre are further amplified.
- ▶ If the output level of a carrier is too low, its sound may become practically inaudible.

CAUTION: For some Preset Voices (125 to 214), the output level of specific carriers is set to "0". For these voices, note that its timbre cannot be changed by editing the carriers of "0" output level or the modulators that modulate those carriers. (Raising the output level will change the timbre.) It is best to check the output level of all carriers before you begin editing.

NOTE: Regarding the Envelope Generator settings, the following generalizations may be stated:

- ▶ "Rate" refers to the transition speed from one level to another level and its value is in inverse proportion to the time required for the transition. So increasing the numeric value of the rate will shorten the time, and decreasing it will lengthen the time.
- ▶ Even if a rate is not changed, the time required for transition can be changed by changing the beginning and ending levels for that rate.
- ▶ If the carrier envelope and modulator envelope differ to an extreme degree, the fluctuations in timbre and volume will deviate over time. Unless you wish to produce a special voice effect, be sure to set both envelopes so that they are the same.
- ▶ Except in special applications, the Attack Rate and Decay 1 Rate values of carriers should not be raised or lowered excessively.
- ▶ Except in special applications, the Attack Level value of carriers should not be lowered excessively.
- ▶ Except in special applications, the Release Rate value of carriers should not be lowered excessively.
- ▶ Except in special applications, the Release Level value of carriers should be left set to "0".

⑩ Press [MEMORY] to register the edited voice.

The MEMORY lamp lights up to indicate that the edited voice is registered. The voice is registered at the Voice No. of User Area selected at Tone Group 1.

If you wish to continue editing of another voice, use DATA ENTRY of Tone Group 1 to select the voice, then repeat Steps ⑤ through ⑩.

NOTE: The Voice data registered in User Area can be saved by transferring it to a RAM Pack. (→see pages 37 and 43)

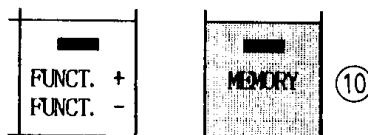

[Tone Group Displays During Voice Edit]

	Tone Group 1	Tone Group 2	Tone Group 3	Tone Group 4
When [F 18] is selected	[E d]	[---]	[---]	[---]
When the voice to be edited is specified	[00 1] - [248] [00 1] - [008] Specified Voice No.	[---]	[000] - [063] Algorithm No.	[---]
During editing after parameter selection		Selection of the operator or operator group	Parameter selection	Data setting (variable range)
		[00 1] : OP 8—OP 5 [00 2] : OP 4—OP 1	[F] Feet	[032] [0 16] [008] [004]
		[0P 1] - [0P 8]	[WF] Waveform	[000] - [007] *See the table below
		[0P 1] - [0P 8]	[OL] Output Level	[000] - [255]
		[0P 1] - [0P 8]	[R↑] Attack Rate	[000] - [100]
		[0P 1] - [0P 8]	[RL] Attack Level	[000] - [100]
		[0P 1] - [0P 8]	[d 1↑] Decay 1 Rate	[000] - [100]
		[0P 1] - [0P 8]	[d 1L] Decay 1 Level	[000] - [100]
		[0P 1] - [0P 8]	[d 2↑] Decay 2 Rate	[000] - [100]
		[0P 1] - [0P 8]	[d 2L] Decay 2 Level	[000] - [100]
		[0P 1] - [0P 8]	[↑↑] Release Rate	[000] - [100]
		[0P 1] - [0P 8]	[↑L] Release Level	[000] - [100]

[Waveforms]

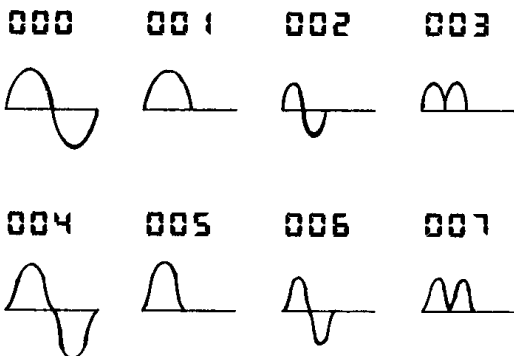

(Waveforms 4 to 7 are the respective squares of Waveforms 0 to 3)

[Envelope Generator]

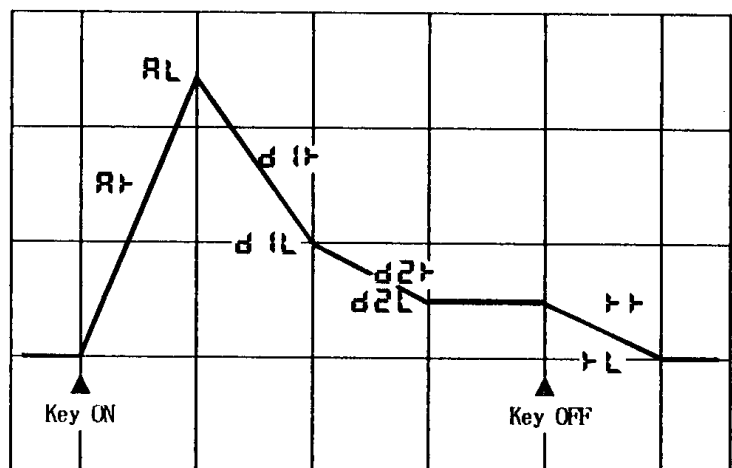

F19

VOICE BANK SELECT (Selects Voice Bank A or B) [FVX-1]

Outline

- With this function, you can select the voices chosen by [VOICE] from either the Preset Area (Voice Bank A) or the User Area (Voice Bank B).
- Voice Banks A and B each have a memory containing 248 voices as well as 8 Common User voices which can be accessed from either Voice Bank.
- The User Area is for copying or editing voices during a Voice Copy or Voice Edit operation. (→see pages 31 and 32)
- Voice Bank Select is a function that is set for the entire unit, so its setting cannot be memorized for individual Tone Groups or Registrations.

Procedure

- 1 Press [FUNCT.] the number of times required to display [F 19] at the Common Display.

When [F 19] is displayed at the Common Display, the currently set Voice Bank is displayed at the Tone Group 4 Display.

- 2 Use DATA ENTRY at Tone Group 4 to select the Voice Bank.

Rotating DATA ENTRY in the clockwise or counter-clockwise direction changes the display as follows:

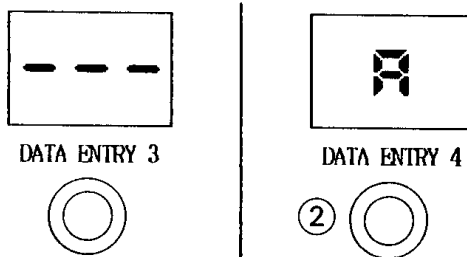
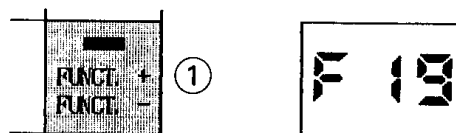
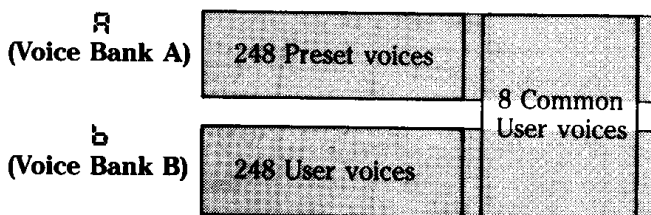

NOTE: In default status (after a reset), Preset voices 1 to 248 are copied to User voices 1 to 248, and Preset voices 1 to 8 are copied to Common User voices 1 to 8.

F20

USER VOICE AREA SELECT (Selects the Voice Area for a RAM Pack Transfer) [FVX-1]

Outline

- When transferring the data of the 248 User voices to or from a RAM Pack, this function is used to select the first half or last half of that data.
- Data is transferred to and from the RAM Pack using Memory Bank MBS-10. For details on the operating procedure, see section V-2, "Reading and Writing User Voice Data." (→see page 43)

Procedure

- 1 Press [FUNCT.] the number of times required to display [F 20] at the Common Display.

When [F 20] is displayed at the Common Display, the currently selected User Voice Area is displayed as a numeric value at the Displays of Tone Groups 2, 3, and 4.

- 2 Use DATA ENTRY at Tone Group 4 to select the first or last half of the User Voice Area.

Rotating DATA ENTRY in the clockwise or counter-clockwise direction changes the Display of Tone Groups 2 and 4 as follows:

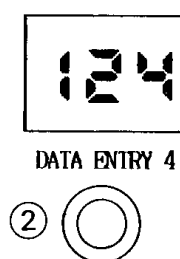
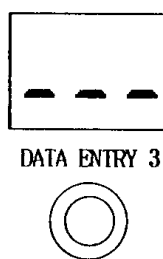
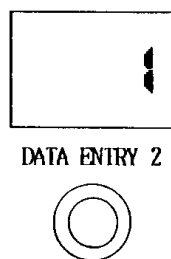

- ▶ [() [()] [124]: Selects the first half of the User voices.
- ▶ [(25) [()] [248]: Selects the last half of the User voices.

IV-1

MEMORY (The Registration Memory)

Outline

- This function lets you memorize up to 16 types of Registrations which are specified for each Tone Group.
- Although most of the functions described in Chapter III can be memorized, certain functions cannot be memorized to Registrations 1 through 16. (➔see page 39)

- The memorized Registrations can be changed according to the Regist. Change (Program Change) signals sent in from an external device.
- By operating the panel, a memorized Registration can be recalled or its contents can be changed. (➔see page 40)

Procedure

① Set the Registrations to be memorized for each Tone Group.

Referring to the description in Chapter III, set the Registrations required for your performance for each Tone Group. (For details on the memorization range of the Registrations, see the next page.)

② While pressing [MEMORY], press one of the selector switches.

During the memorization of a Registration, the eight selector switches function to specify the Registration No. Two rows of numeric values are provided at the side of each switch, and the numeric values are used to specify Registration Nos. (hereafter referred to as a "Regist. No.") during memorization. The procedure for memorizing registrations to Regist. Nos. 1 to 16 is as follows:

▶ **Regist. Nos. 1-8 (top row):** While pressing [MEMORY], press a selector switch. (The figure on the right is an example of memorizing to Regist. No. 1.)

▶ **Regist. Nos. 9-16 (bottom row):** While pressing [MEMORY], simultaneously press [SHIFT] and a selector switch. (Press [MEMORY] and [SHIFT] with your right hand, and a selector switch with your left hand.)

When the above operation is performed, the lamp of the pressed selector switch flashes to indicate that a Registration has been memorized to the specified Regist. No.

NOTE: The currently set Regist. No. is usually displayed at the Common Display (except when using the EFF., VIBRATO, FUNCT. switches, etc.). A Registration can be memorized, however, to any Regist. No. regardless of this display. (➔see page 40)

③ If necessary, set another Registration and memorize it to another Regist. No.

Because the Regist. Nos. are changed by the Regist. Change signals sent in from an external device, be sure to select Regist. Nos. that are compatible with those of a transmitting instrument, such as HX, or those of another Voice Expander. (Be sure to use the Registration Charts provided in Chapter VI, "OTHER INFORMATION, as well as Data Recording Charts provided at the back of the MDX-1 USER'S GUIDE.)

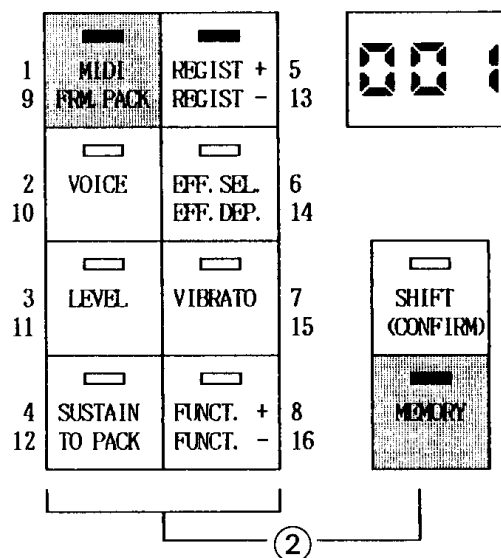

④ When a Regist. Change signal is received from an external device, the registrations are changed.

The signal which changes the registrations is sent and received as a MIDI Channel Message of Program Change type; it is sent from HX using Channel 16. When this signal is sent in, the Voice Expander will receive that signal regardless of the MIDI Channel settings, and the registrations will be changed (at each Tone Group where [MIDI ENABLE] is ON).

CAUTION: For Tone Groups at which Regist. Change Enable is set to OFF, the registration is not changed even if the Regist. Change signal is received. (➔see page 27)

NOTE: The signals for Regist. Nos. 1-16 of HX correspond directly to Regist. Nos. 1-16 of the Voice Expander. When a Regist. No. is changed at HX, therefore, the Registration having that same Regist. No. is set. Certain non-Electone instruments are designed so that the Program Change signals are received by pressing the VOICE switch. (Be sure to check the MIDI Implementation Chart and other specifications for that instrument.)

NOTE: The data of the memorized Registration can be sent as Bulk data to MDX-1 to be saved. (➔Refer to the "MDX-1 USER'S GUIDE.") The data can also be saved in a RAM Pack using MBS-10. (➔see page 42)

[The Data That Can Be Memorized to Registration Memory] (→see page 7)

Function	Data	Default
[VOICE]	Voice No. selection data	[00 1]
[LEVEL]	Volume level data	[024]
[SUSTAIN]	Sustain Length data	[000]
[EFF. SEL.]	Effector selection data	[OFF]
[EFF. DEP.]	Parameters of selected Effector	[---]
[OCT. SHIFT] (AVX-1)	Setting data for Octave Shift	[000]
[FUNCT.] ① BRILLIANCE	Setting data for Brilliance	[000]
② TOUCH TONE RANGE	Range data for Touch Tone	[0 10]
③ PAN MODE SELECT	Pan mode selection data	[00 1]
④ PAN PARAMETER SET	Parameters of the selected Pan Mode	[[]]
⑤ AUX. OUT LEVEL	Output level data for AUX. OUT	[000]
⑥ NOTE DOUBLER	Setting data for Note Doubler	[000]
⑦ DETUNE	Setting data for Detune	[000]
⑧ KEY SHIFT	Setting data for Key Shift	[000]
⑭ GLIDE ENABLE	Glide enable/disable data	[OFF]
⑮ PITCH BEND RANGE (FVX-1)	Range data for Pitch Bend	[000]
⑯ VIBRATO CONTROL SEL (FVX-1)	Vibrato controller selection data	[OFF]

CAUTION: The following settings can be performed for individual Tone Groups but cannot be memorized to Registrations 1 to 16: MIDI ENABLE ON/OFF, MIDI receiving channel, Function Nos. ⑨ KEY LIMIT [HIGH], ⑩ KEY LIMIT [LOW], and ⑪ REGIST. CHANGE ENABLE. With the other functions under [FUNCT.], the data be set for the entire unit.

NOTE: The [VIBRATO] function of FVX-1 lets you set Vibrato data for individual voices. If you memorize Registrations having different voices under different Regist. Nos., the Vibrato data can also be changed easily. Please note, however, that different Vibrato data cannot be memorized for the same voice.

[The Registration Memory for Individual Tone Groups]

When you perform the procedure described on the previous page, the Registrations currently set by the panel for all Tone Groups are memorized in one operation. In addition, you can also memorize the Registration of a single Tone Group as follows: While pressing the MEMORY switch, press the MIDI ENABLE switch. (→for details, see page 41)

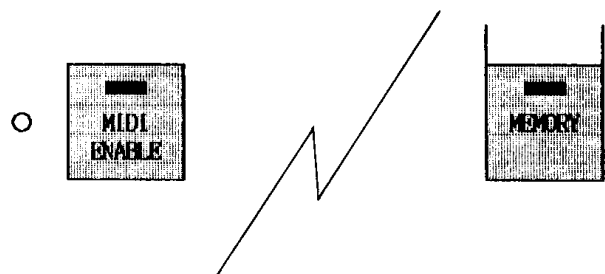

Outline

- A memorized Registration can be recalled to the panel for editing.
- A Registration is recalled by using the REGIST switch to change the Regist. No. one at a time. Depending on the status at that time, however, the Regist. No. may not change.
- Be sure to memorize the edited Registration before recalling another Registration. (If another Registration is recalled without memorizing the edited one, the edited data will be erased.)
- It is also possible to recall and edit a different Regist. No. at each Tone Group.

Procedure

① **Check the Common Display.**

The Common Display usually displays the currently set Regist. No. as a two-digit value (while the REGIST lamp is lit). The first-column display changes as shown in the table below if a Registration is being edited (whether the contents of the memorized Registration matches the panel status).

CAUTION: When the Common Display shows that a Registration is being edited, use the procedure described on the previous page to memorize the edited Registration. When memorization is completed, the contents of the Registration memory is changed and Common Display changes from Edit mode to Pre-Edit status mode (from [_ 0 1] to [0 0 1] in the sample table below).

CAUTION: When setting an EFFECTOR, VIBRATO, or FUNCTION, the REGIST lamp goes out and the Common Display conforms to the feature being set. When the REGIST switch is pressed while the Common Display is in this status, the currently set Regist. No. is displayed so memorize the edited data then return the Common Display to its Pre-Edit status ([0 0 1] in the table below).

CAUTION: When the REGIST switch is pressed during editing, the Regist. No. display begins flashing to prompt you to memorize the data. At this time, if you press the REGIST switch once more without memorizing the data, please note that the Common Display returns to its Pre-Edit status, the contents of the memorized Registration is restored, and the edited data is erased.

[Sample Display of the Common Display] (For Regist. No. 1)

Display	Meaning of Display	When the REGIST Switch is Pressed
0 0 1	The Registration memorized at No. 1 is set for all Tone Groups. (Pre-Edit status)	The Regist. No. is changed each time [REGIST] is pressed, and the Registration of the selected No. is recalled to the panel.
_ 0 1	The Registration memorized at No. 1 is being edited. (Edit status)	The display of the current Regist. No. flashes to prompt you to memorize its data. (If you press [REGIST] once more, the display changes to [0 0 1] and the edited data is erased.)
Other	The EFFECTOR, VIBRATO, or FUNCTION is being set. (Edit status)	The currently set Regist. No. [_ 0 1] is displayed. (If you press [REGIST] once more, the display flashes to prompt you to memorize the data.)

② **Press [REGIST] the number of times required to select the Regist. No. you wish to edit.**

When the REGIST switch is pressed while the Common Display is in Pre-Edit status, the Regist. No. is changed.

- ▶ **Pressing only [REGIST]:** The Regist. No. is increased by one each time [REGIST] is pressed.
- ▶ **Pressing [SHIFT]+[REGIST]:** The Regist. No. is decreased by one each time [SHIFT]+[REGIST] are pressed.

③ **Edit the Registration at the panel.**

When the Regist. No. is changed in Step ②, the Registration memorized at that No. is set for all Tone Groups. Press the selector switch of the function you wish to edit, then change the data that is set at each Tone Group.

CAUTION: While only the REGIST lamp is lit among the selector switches (when [REGIST] is pressed during the setting of the EFFECTOR, VIBRATO, or FUNCTION), if you press the the REGIST switch and change the Regist. No., the lamps of the selector switches flash (and [- - -] flashes at each Tone Group Display) to prompt you to select one of them.

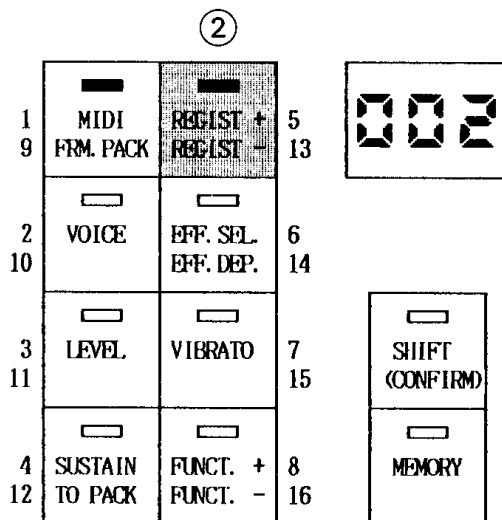

④ **Memorize the edited Registration.**

When a Registration is edited, the Regist. No. at the Common Display is in Edit status. When editing is completed, memorize the Registration to the same Regist. No. The Common Display changes to the Pre-Edit status.

[Editing a Single Tone Group in REGIST. CHANGE Mode]

- ① While pressing [COARSE], press [REGIST] to enter the REGIST. CHANGE mode.

If the REGIST switch is pressed while pressing the COARSE switch, [] (RCM: REGIST. CHANGE Mode) is shown at the Common Display so that different Registrations can be set at different Tone Groups.

At this time, the currently set Regist. No. is shown at each Tone Group Display.

NOTE: If REGIST. CHANGE ENABLE is set to OFF for any Tone Group and a Regist. Change signal is received from an external device, a different Regist. No. will be set at those Tone Groups. (For example, if Tone Group 1 is set to OFF and the Regist. No. is changed from 1 to 2 to 3, Tone Group 1 will remain set to Regist. No. 1.) The REGIST. CHANGE mode thus actually recalls a different Regist. No. for individual Tone Groups, which is useful when editing a specific Tone Group.

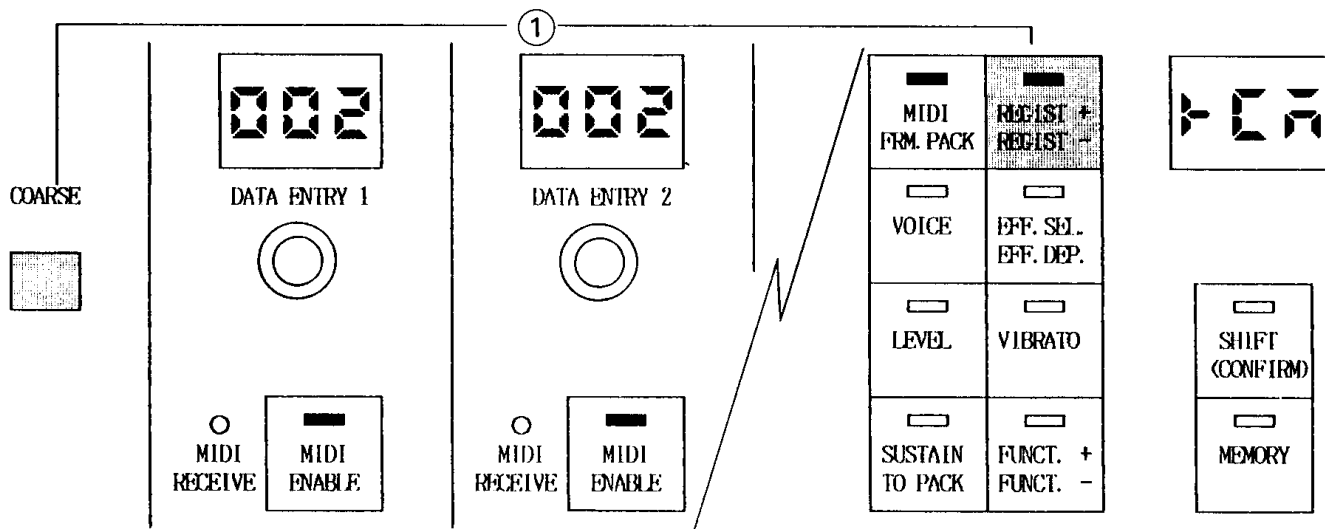

- ② Use DATA ENTRY at each Tone Group to change the Regist. No.

Rotating DATA ENTRY in the clockwise direction increases the Regist. No.; rotating it in the counter-clockwise direction decreases it. Change the Regist. No. at any Tone Group. When you change the Regist. No. at a Tone Group, the Registration corresponding to the set Regist. No. is set at the panel.

- ③ Edit the Registration at the panel.

While checking the sound by producing notes as during a performance, edit the Registration. Editing can be performed on any Tone Group, whether its Regist. No. has been changed or not.

NOTE: When the Regist. No. of any Tone Group is changed, the Common Display changes to [] (Individual) to indicate that the Regist. No. varies with the Tone Group.

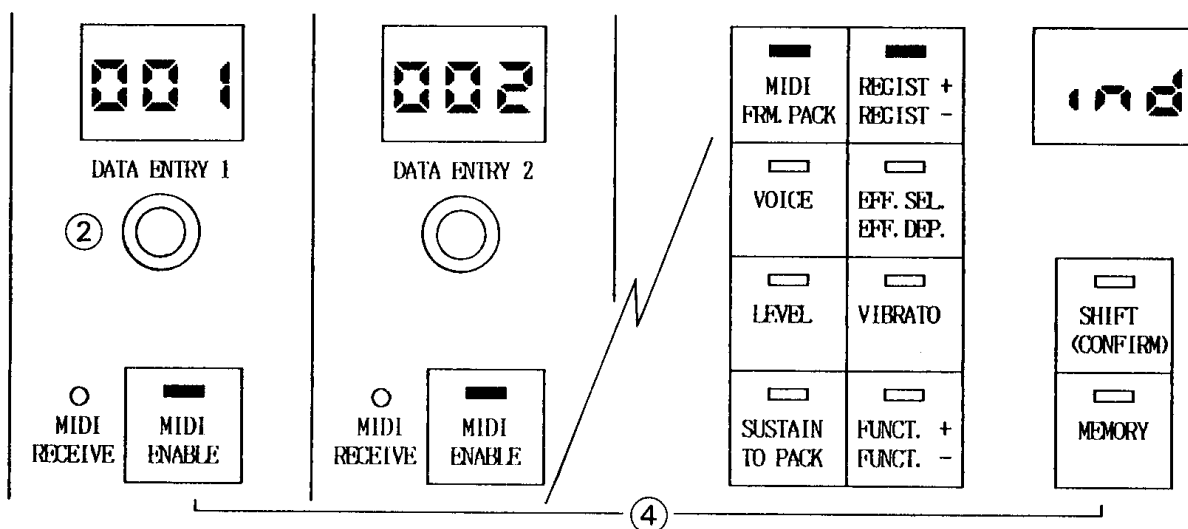

- ④ While pressing [MEMORY], press [MIDI ENABLE] at the Tone Group you have edited.

The lamp of the pressed MIDI ENABLE switch begins flashing to indicate that only the Registration of that Tone Group has been memorized to the Regist. No. set at that Tone Group. (→see page 39)

CAUTION: Perform Step ④ to memorize the data for each Tone Group which was edited in REGIST. CHANGE mode. If the procedure described on page 38 is performed, the data of all Tone Groups will be memorized to the same Regist. No. Moreover, if the REGIST switch is pressed while the [] display is flashing, the edited data will be erased.

V-1 Reading and Writing the Registration Data

Outline

- If Memory Bank MBS-10 is connected, you can write the various data set by the Voice Expander onto a RAM Pack (To Pack) or read the data written onto a RAM Pack (From Pack).
- Besides Registration data, Common User voice data and other data can also be written and saved to a RAM Pack (FVX-1 only).

- With a system using MDX-1, the Registration data that can be transferred to and from a RAM Pack can also be transferred to and from MDX-1. (⇒ Refer to the "MDX-1 USER'S GUIDE" for details.)

Procedure (To Pack)

- ① **Set the data to be written to the RAM Pack.**
The data that can be written to a RAM Pack by a To Pack operation is as follows: (⇒ see pages 39 and 49)
Registration data ▶ Registration Memory 1-16
 ▶ Functions set for each Tone Group
 ▶ Vibrato (Preset/Common User voices) [FVX-1]
 ▶ The current panel status
Voice data ▶ Common User voices 1-8 [FVX-1]
Unit data ▶ Program Effectors 1-4
 ▶ Key Mode Select [AVX-1]
 ▶ Voice Bank Select [FVX-1]
 ▶ Others (except Tuning and User Voice data)

- ② **Insert the RAM Pack into MBS-10.**
After checking the connection to MBS-10, securely insert the RAM Pack. (⇒ Refer to the "MBS-10 USER'S GUIDE")
 ▶ **Compatible RAM Packs:** RP-3 (8K bytes)
 RP-5 (32K bytes)

- ③ **While pressing [CONFIRM], press [TO PACK].**
The SUSTAIN/TO PACK lamp begins flashing to indicate that the data has been written to the RAM Pack.

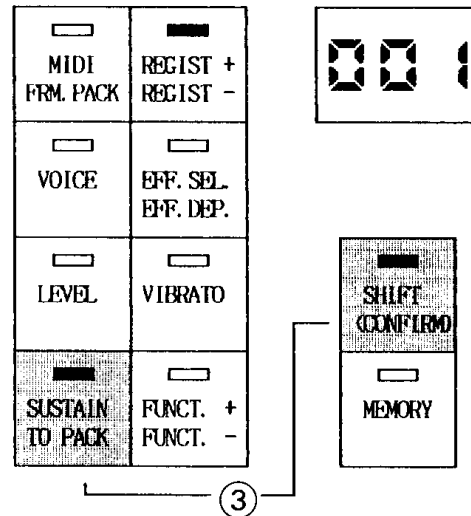

Procedure (From Pack)

- ① **Insert the RAM Pack into MBS-10.**
After checking the connection to MBS-10 and checking the RAM Pack from which data will be read, securely insert the RAM Pack.
- ② **While pressing [CONFIRM], press [FROM PACK].**
The MIDI/FROM PACK lamp begins flashing to indicate that the data has been read from the RAM Pack to the Voice Expander.

NOTE: In case MBS-10 is improperly connected or an error occurs during data transfer, the Common Display will show a Status Code (such as [003], etc.) to attract your attention. (⇒ see page 55)

NOTE: A To Pack or From Pack operation for Registration data can also be performed at the MBS-10 panel.

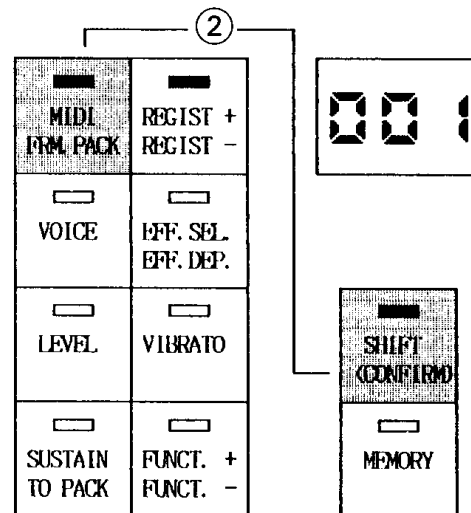

Outline

- With FVX-1, only User Voice data for Voice Nos. 1 to 248 can be transferred to and from a RAM Pack.
- The reading and writing of User Voice data is only possible while USER VOICE AREA SELECT is displayed at the panel, and cannot be performed from the MBS-10 panel.
- Before transferring the User Voice data to or from a RAM Pack (RP-5), the first or last half of the User Voice Area must be selected.
- The User Voice data can only be transferred to and from a RAM Pack, but cannot be transferred to and from MDX-1.

Procedure (To Pack)

- ① Press [FUNCT.] the number of times required to display [F 20] at the Common Display.

CAUTION: User Voice data can be written or read only while Function No. 20 is displayed at the panel.

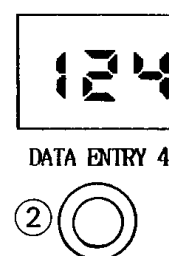
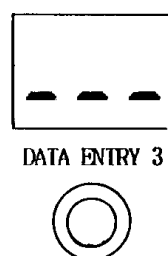
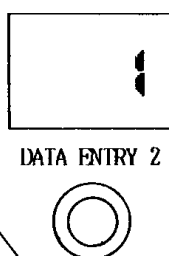
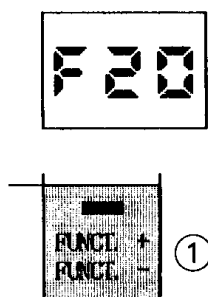

- ② Use DATA ENTRY of Tone Group 4 to select the User Voice Area to be written to the RAM Pack. (→see page 37)

▶ [1] [---] [124]: First half of area
▶ [125] [---] [248]: Last half of area

- ③ Insert the RAM Pack (RP-5) into MBS-10. After checking the connection to MBS-10, securely insert the RAM Pack. (→Refer to the "MBS-10 USER'S GUIDE.")

▶ **Compatible RAM Packs:** RP-5 (32K bytes)

- ④ While pressing [CONFIRM], press [TO PACK]. The SUSTAIN/TO PACK lamp begins flashing to indicate that the data of the selected User Voice Area has been written to the RAM Pack.

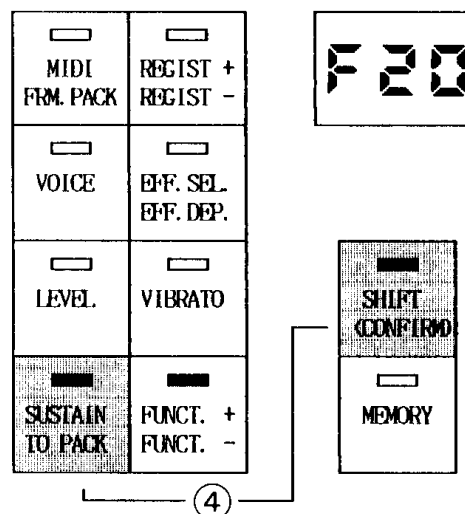

Procedure (From Pack)

- ① Display Function No. 20 [F 20], then select the User Voice Area of the data you wish to read. Similar to the To Pack operation, use DATA ENTRY of Tone Group 4 to select the first or last half of the User Voice Area.

- ② Insert the RAM Pack (RP-5) into MBS-10.

- ③ While pressing [CONFIRM], press [FROM PACK]. The MIDI/FROM PACK lamp begins flashing to indicate that the RAM Pack Voice data has been read (memorized) to the selected User Voice Area of the Voice Expander.

NOTE: In case MBS-10 is improperly connected or an error occurs during data transfer, the Common Display will show a Status Code (such as [C 0 3], etc.) to attract your attention. (→see page 55)

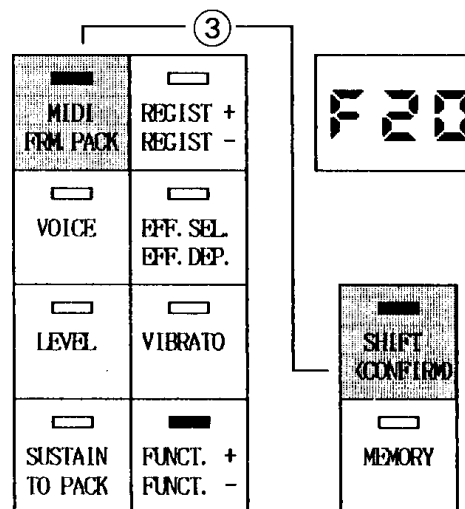

VI. OTHER INFORMATION

The Preset Voices [FVX-1]

[1]

VOICE No.	VOICE NAME	PRESET VIBRATO			PRESET PAN	PRESET EFFEC.
		DEPTH	DELAY	SPEED		
000001	HX * STRINGS 1	17	24	46	STEREO	---
000002	HX * STRINGS 2	9	30	45	C	SYM
000003	HX * STRINGS 3	22	12	46	STEREO	---
000004	HX * STRINGS 4	24	24	48	C	---
000005	HX * STRINGS 5	17	24	46	STEREO	CEL
000006	HX * PIZZICATO STRINGS	0	0	0	L	SYM
000007	HX * VIOLIN 1	26	30	46	L	---
000008	HX * VIOLIN 2	26	30	47	L	---
000009	HX * CELLO	26	32	42	R	---
000010	HX * BRASS 1	7	30	48	R	---
000011	HX * BRASS 2	8	30	42	C	---
000012	HX * BRASS 3	7	30	48	L	CEL
000013	HX * BRASS 4	1	36	42	L	---
000014	HX * BRASS 5	11	30	48	STEREO	---
000015	HX * TRUMPET 1	11	15	39	C	---
000016	HX * TRUMPET 2	11	30	39	C	---
000017	HX * TRUMPET 3	8	28	39	STEREO	---
000018	HX * TROMBONE 1	15	30	38	R	---
000019	HX * TROMBONE 2	15	30	38	R	---
000020	HX * TROMBONE 3	15	30	38	STEREO	---
000021	HX * HORN	2	30	36	L	---
000022	HX * WOOD 1	9	32	40	R	---
000023	HX * WOOD 2	0	24	0	L	---
000024	HX * WOOD 3	7	14	43	STEREO	---
000025	HX * PICCOLO	3	24	46	L	---
000026	HX * FLUTE 1	20	28	45	R	---
000027	HX * FLUTE 2	20	28	45	R	---
000028	HX * OBOE 1	2	6	48	C	---
000029	HX * OBOE 2	2	6	48	C	---
000030	HX * ENGLISH HORN	2	28	40	R	---
000031	HX * BASSOON	2	28	36	C	---
000032	HX * CLARINET 1	1	28	46	L	---
000033	HX * CLARINET 2	1	28	46	L	---
000034	HX * BASS CLARINET	1	28	46	R	---
000035	HX * ALTO SAX	13	32	38	C	---
000036	HX * TENOR SAX	17	32	37	R	---
000037	HX * ACCORDION	3	14	51	L	---
000038	HX * BANDONEON	1	14	51	LL	---
000039	HX * HARMONICA	4	18	36	R	---
000040	HX * VOCAL 1	18	8	46	R	SYM
000041	HX * VOCAL 2	18	8	51	L	SYM
000042	HX * VOCAL 3	18	8	51	R	SYM
000043	HX * VOCAL 4	18	8	51	L	SYM
000044	HX * COSMIC 1	7	30	50	STEREO	DEL
000045	HX * COSMIC 2	1	24	36	C	---
000046	HX * COSMIC 3	0	0	0	L	CEL
000047	HX * COSMIC 4	25	18	38	C	DEL
000048	HX * COSMIC 5	12	42	42	L	---
000049	HX * COSMIC 6	22	30	46	STEREO	SYM
000050	HX * ELECTRIC PIANO 1	0	0	0	R	CEL
000051	HX * ELECTRIC PIANO 2	0	0	0	C	---
000052	HX * ELECTRIC PIANO 3	0	0	0	STEREO	---
000053	HX * ELECTRIC PIANO 4	3	0	26	L	CEL
000054	HX * PIANO 1	0	0	0	L	---
000055	HX * PIANO 2	0	0	0	L	---
000056	HX * PIANO 3	0	0	0	L	---
000057	HX * GUITAR 1	3	19	89	R	---
000058	HX * GUITAR 2	2	19	89	L	---
000059	HX * JAZZ GUITAR 1	3	36	36	C	---
000060	HX * JAZZ GUITAR 2	3	36	37	C	---
000061	HX * ELECTRIC GUITAR 1	1	32	35	RR	PHA
000062	HX * ELECTRIC GUITAR 2	2	24	33	R	FLA

VOICE No.	VOICE NAME	PRESET VIBRATO			PRESET PAN	PRESET EFFEC.
		DEPTH	DELAY	SPEED		
000063	HX * ELECTRIC GUITAR 3	3	32	35	RR	PHA
000064	HX * VIBRAPHONE	0	0	0	R	---
000065	HX * MARIMBA	0	0	0	LL	---
000066	HX * XYLOPHONE	0	0	0	LL	---
000067	HX * GLOCKEN SPIEL	0	0	0	C	---
000068	HX * CELESTA	0	0	0	LL	---
000069	HX * HARPSICHORD	0	0	0	R	---
000070	HX * HARP 1	0	0	0	L	---
000071	HX * HARP 2	0	0	0	L	---
000072	HX * BANJO	0	0	0	RR	---
000073	HX * MANDOLIN	0	0	0	L	---
000074	HX * SHAMISEN	3	0	40	C	---
000075	HX * KOTO	3	14	23	L	---
000076	HX * TAISHOGOTO	0	0	0	R	---
000077	HX * CHIME 1	2	30	45	LL	---
000078	HX * CHIME 2	1	4	26	C	CEL
000079	HX * CARILLON	1	30	45	RR	---
000080	HX * STEEL DRUM 1	0	0	0	C	---
000081	HX * STEEL DRUM 2	0	0	0	C	CEL
000082	HX * TIMPANI 1	0	0	0	L	---
000083	HX * TIMPANI 2	0	0	0	L	---
000084	HX * ELECTRIC BASS 1	0	0	0	C	---
000085	HX * ELECTRIC BASS 2	0	0	0	C	---
000086	HX * ELECTRIC BASS 3	0	0	0	C	---
000087	HX * ELECTRIC BASS 4	0	0	0	C	---
000088	HX * COSMIC 7	0	0	0	L	---
000089	HX * COSMIC 8	3	30	38	R	PHA
000090	HX * COSMIC 9	0	0	0	C	PHA
000091	FVX * STRINGS 1	31	20	46	STEREO	---
000092	FVX * STRINGS 2	12	4	50	C	---
000093	FVX * STRINGS 3	3	24	47	C	CEL
000094	FVX * VIOLIN 1	28	13	49	L	---
000095	FVX * CELLO 1	24	25	49	R	---
000096	FVX * CONTRA BASS 1	15	24	41	RR	---
000097	FVX * PIZZ. VIOLIN 1	0	0	38	L	---
000098	FVX * PIZZ. CELLO 1	0	0	38	R	---
000099	FVX * PIZZ. CONTRA BASS 1	0	20	48	C	---
000100	FVX * BRASS 1	5	24	41	C	---
000101	FVX * BRASS 2	9	24	41	C	---
000102	FVX * TRUMPET 1	12	16	38	C	---
000103	FVX * TROMBONE 1	19	20	38	C	---
000104	FVX * TROMBONE 2	14	20	38	C	---
000105	FVX * HORN 1	3	28	40	C	---
000106	FVX * HORN 2	2	24	41	L	---
000107	FVX * TUBA 1	10	16	36	C	---
000108	FVX * FLUTE 1	13	16	44	C	---
000109	FVX * CLARINET 1	2	24	46	C	---
000110	FVX * SAXOPHONE 1	19	26	34	C	---
000111	FVX * ELECTRIC PIANO 1	0	0	0	L	---
000112	FVX * HARP 1	0	0	38	LL	---
000113	FVX * HARP 2	0	0	38	LL	---
000114	FVX * ACOUSTIC GUITAR 1	0	20	38	L	---
000115	FVX * DISTOR. GUITAR 1	6	96	31	C	---
000116	FVX * CHOP. BASS 1	0	0	0	C	---
000117	FVX * XYLOPHONE 1	0	0	0	LL	---
000118	FVX * KALIMBA 1	0	0	0	LL	---
000119	FVX * TRIANGLE 1	0	0	0	LL	---
000120	FVX * VOCAL 1	11	8	50	C	---
000121	FVX * ORGAN 1	0	0	40	C	---
000122	FVX * SYNTH STRING 1	9	8	50	C	---
000123	FVX * SYNTH BRASS 1	5	24	41	C	---
000124	FVX * SYNTH LEAD 1	16	0	50	C	---

VOICE No.	VOICE NAME	PRESET VIBRATO			PRESET PAN	PRESET EFFEC.
		DEPTH	DELAY	SPEED		
HS *	COMBI. 1	0	0	41	C	----
HS *	COMBI. 2	0	0	41	C	----
HS *	COMBI. 3	0	0	41	C	----
HS *	COMBI. 4	0	0	41	C	----
HS *	COMBI. 5	0	0	41	C	----
HS *	COMBI. 6	0	0	41	C	----
HS *	COMBI. 7	0	0	41	C	----
HS *	COMBI. 8	0	0	41	C	----
HS *	COMBI. 9	0	0	41	C	----
HS *	PIPE ORGAN 1	0	0	40	C	----
HS *	PIPE ORGAN 2	0	0	40	STEREO	----
HS *	PIPE ORGAN 3	0	0	40	STEREO	----
HS *	STRINGS 1	3	12	43	C	SYM
HS *	STRINGS 2	3	12	42	C	SYM
HS *	STRINGS 3	7	12	45	C	----
HS *	PIZZ. STRINGS	8	0	44	C	----
HS *	BRASS 1	4	12	42	STEREO	----
HS *	BRASS 2	2	12	38	C	----
HS *	BRASS 3	2	12	38	STEREO	----
HS *	MUTE BRASS 1	2	12	41	STEREO	----
HS *	MUTE BRASS 2	2	12	38	STEREO	----
HS *	WOOD 1	3	12	42	C	----
HS *	WOOD 2	3	12	42	STEREO	----
HS *	ACCORDION	1	12	36	STEREO	----
HS *	SYNTH STRING	1	12	46	C	----
HS *	SYNTH BRASS	6	12	42	C	----
HS *	COSMIC 1	6	12	42	STEREO	----
HS *	COSMIC 2	1	0	100	C	----
HS *	COSMIC 3	1	12	38	STEREO	----
HS *	COSMIC 4	9	12	48	STEREO	SYM
HS *	COSMIC 5	8	12	44	STEREO	SYM
HS *	VOCAL 1	8	12	45	STEREO	SYM
HS *	VOCAL 2	8	12	45	STEREO	SYM
HS *	VOCAL 3	8	12	42	STEREO	SYM
HS *	VOCAL 4	8	12	42	STEREO	SYM
HS *	IMAGE 1	100	0	34	C	----
HS *	PIANO 1	1	0	38	STEREO	----
HS *	PIANO 2	1	0	38	STEREO	----
HS *	ELEC. PIANO 1	1	0	36	STEREO	----
HS *	ELEC. PIANO 2	1	0	36	STEREO	----
HS *	TOY PIANO	1	0	38	STEREO	----
HS *	MUSIC BOX	1	0	41	STEREO	----
HS *	GLASS HARP	1	0	38	STEREO	----
HS *	HARPSICHORD	1	0	38	C	----
HS *	HARP	1	0	38	STEREO	----
HS *	ACOUST. GUITAR 1	1	18	38	STEREO	----
HS *	ACOUST. GUITAR 2	1	18	38	STEREO	----
HS *	JAZZ GUITAR	2	18	38	STEREO	----
HS *	ELEC. GUITAR 1	2	24	40	STEREO	----
HS *	ELEC. GUITAR 2	2	18	38	STEREO	----
HS *	BACKING GUITAR	3	18	40	STEREO	----
HS *	DISTOR. GUITAR	10	30	40	C	----
HS *	STEEL GUITAR	4	18	40	C	----
HS *	VIBRAPHONE	0	0	0	STEREO	----
HS *	MARIMBA	1	0	38	STEREO	----
HS *	CELESTA	1	0	38	C	----
HS *	BANJO	2	12	38	STEREO	----
HS *	KOTO	3	12	36	STEREO	----
HS *	STEEL DRUM	3	0	32	C	----
HS *	TIMPANI	1	12	34	C	----
HS *	CLAVI	3	12	38	STEREO	----
HS *	CHIME	1	0	38	STEREO	----

VOICE No.	VOICE NAME	PRESET VIBRATO			PRESET PAN	PRESET EFFEC.
		DEPTH	DELAY	SPEED		
HS *	WAVE	0	0	0	C	----
HS *	VIOLIN	15	18	46	STEREO	----
HS *	CELLO	14	24	42	STEREO	----
HS *	TRUMPET	5	24	42	C	----
HS *	FLUGEL HORN	4	18	41	C	----
HS *	TROMBONE	16	28	38	C	----
HS *	HORN	3	30	38	STEREO	----
HS *	PICCOLO	8	28	43	C	----
HS *	FLUTE	13	18	42	C	----
HS *	OBOE	4	18	42	C	----
HS *	BASSOON	8	30	38	STEREO	----
HS *	CLARINET	3	30	41	STEREO	----
HS *	SAXOPHONE	5	28	39	C	----
HS *	PAN FLUTE	12	30	43	C	----
HS *	RECORDER	4	26	42	C	----
HS *	HARMONICA	4	24	38	C	----
HS *	WHISTLE	14	24	49	C	----
HS *	SYNTH LEAD	26	30	42	C	----
HS *	COMBI. BASS 1	1	8	38	C	----
HS *	COMBI. BASS 2	1	8	38	C	----
HS *	CONTRA BASS 1	3	8	40	C	----
HS *	CONTRA BASS 2	3	12	38	C	----
HS *	ELEC. BASS 1	1	12	40	C	----
HS *	ELEC. BASS 2	1	12	38	C	----
HS *	ELEC. BASS 3	1	18	38	C	----
HS *	TUBA	2	12	40	C	----
HS *	SYNTH BASS 1	4	12	38	C	----
HS *	SYNTH BASS 2	4	26	40	C	----
FVX *	VIOLIN 2	20	17	38	C	----
FVX *	CELLO 2	12	20	40	C	----
FVX *	NEO STRING 1	0	6	38	C	CEL
FVX *	NEO STRING 2	0	6	38	C	CEL
FVX *	NEO STRING 3	9	10	43	STEREO	----
FVX *	TRUMPET 2	5	9	41	C	----
FVX *	TROMBONE FX	11	19	44	STEREO	----
FVX *	FRENCH HORN	0	6	38	STEREO	----
FVX *	NEO BRASS 1	0	6	40	STEREO	----
FVX *	NEO BRASS 2	0	6	40	STEREO	CEL
FVX *	NEO BRASS 3	10	11	42	C	CEL
FVX *	OBOE 1	7	27	36	C	----
FVX *	ENGLISH HORN 1	6	10	41	C	----
FVX *	CLARINET 2	0	6	38	C	----
FVX *	FUE FUE	17	17	42	C	----
FVX *	NEO PERC. 1	0	0	40	C	----
FVX *	NEO PERC. 2	0	0	40	C	----
FVX *	NEO PERC. 3	0	0	40	C	----
FVX *	NEO PERC. 4	40	8	22	STEREO	----
FVX *	NEO PERC. 5	100	4	100	STEREO	----
FVX *	NEO PERC. 6	0	4	26	STEREO	----
FVX *	NEO PERC. 7	21	2	12	STEREO	CEL
FVX *	-ZINC-	0	0	40	C	CEL
FVX *	ORIENT HARP	9	8	25	C	----
FVX *	-HAL9000-	0	0	40	STEREO	CEL
FVX *	PEDAL-SFX-	10	12	36	STEREO	CEL
FVX *	-GENEVA-	0	0	40	C	CEL
FVX *	GLASS BELL 1	0	0	40	STEREO	----
FVX *	GLASS BELL 2	0	0	40	STEREO	CEL
FVX *	-ZOMBI-	100	20	3	STEREO	----
FVX *	-BYOOON-	0	0	40	STEREO	----
FVX *	-NOIZE-	0	1	100	STEREO	----
FVX *	BROKEN CHIME	0	0	40	C	CEL
FVX *	8BIT VOICE	14	15	9	STEREO	SYM

The Algorithm Patterns (FVX-1)

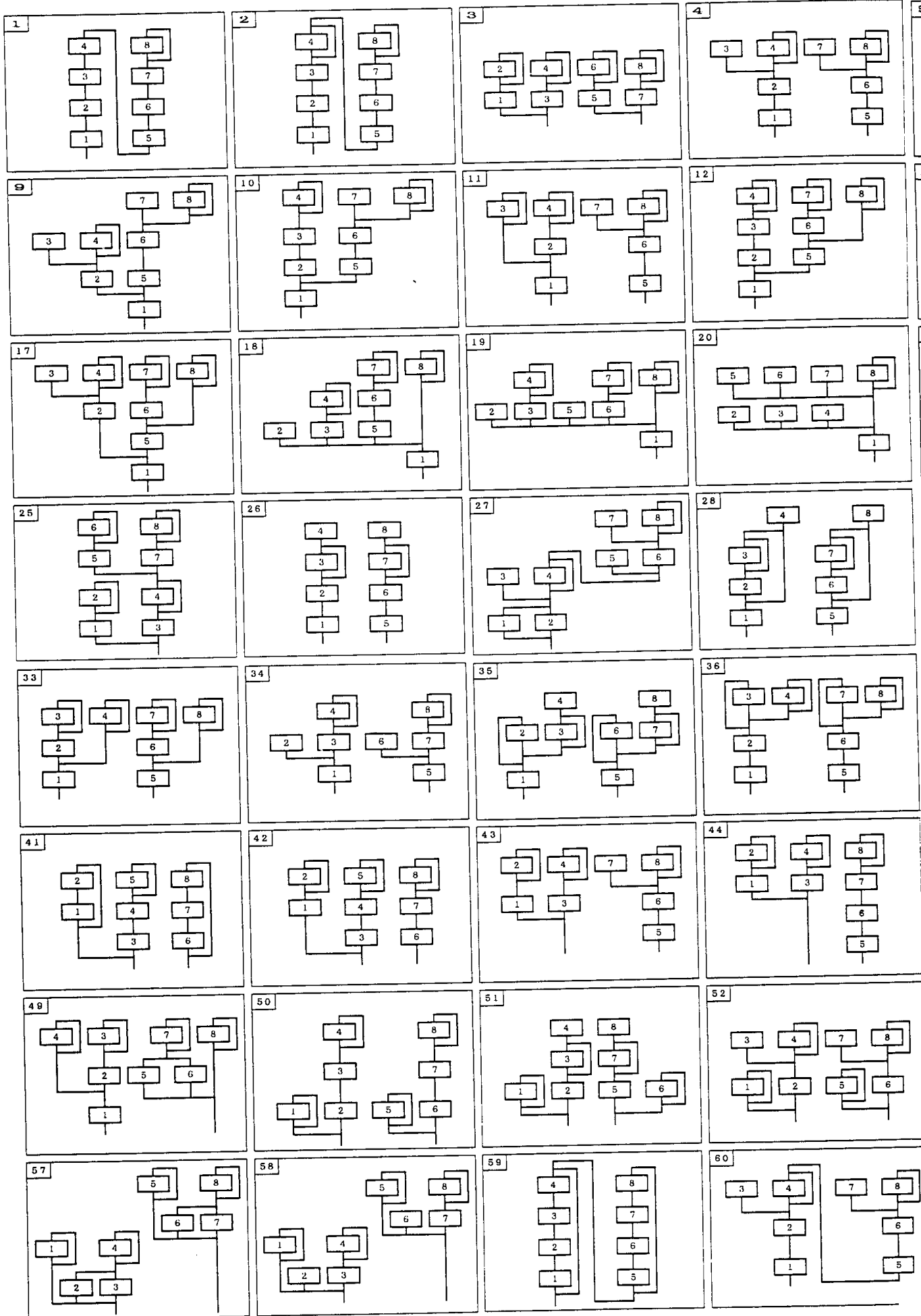

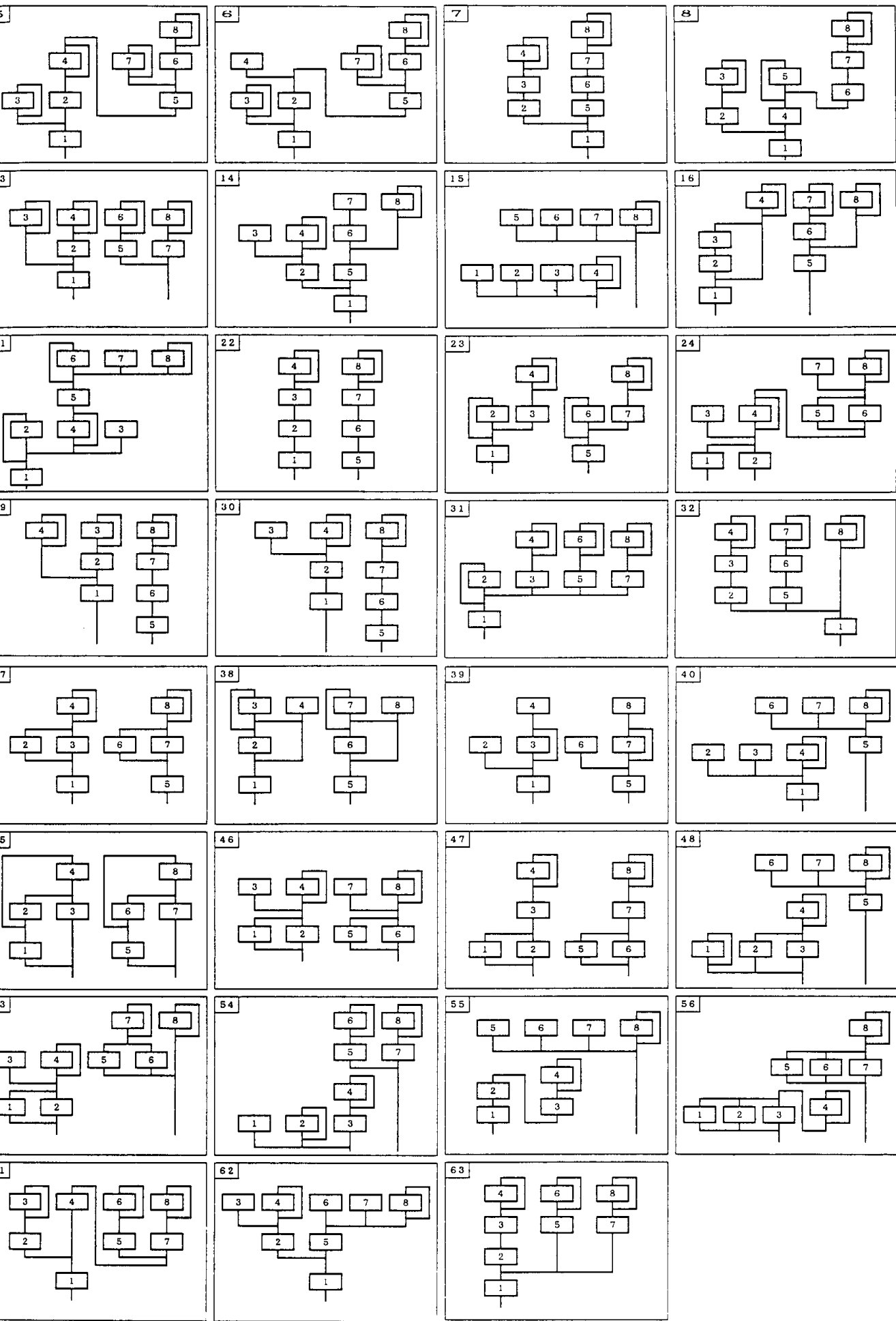

The Default Settings (The Status After the Unit is Reset)

Data item		Tone Group 1	Tone Group 2	Tone Group 3 (FVX-1)	Tone Group 4 (FVX-1)
Initial Panel Status	Common Display (Regst. No.)	[00 1]			
	Selector switch	[MIDI] ON			
	MIDI ENABLE	ON	ON	ON	ON
	Tone Group Displays (MIDI Receiving Channel)	[00 1]	[002]	[003]	[004]
Registration Data (Common for Nos. 1 to 16)	VOICE	[00 1]	[00 1]	[00 1]	[00 1]
	LEVEL	[024]	[024]	[024]	[024]
	SUSTAIN	[000]	[000]	[000]	[000]
	EFFECTOR SELECT	[OFF]	[OFF]	[OFF]	[OFF]
	EFFECTOR DEPTH (see NOTE 1)	[---]	[---]	[---]	[---]
	OCTAVE SHIFT (AVX-1)	[000]	[000]	—	—
	FUNCTION ① BRILLIANCE	[000]	[000]	[000]	[000]
	② TOUCH TONE RANGE	[0 10]	[0 10]	[0 10]	[0 10]
	③ PAN MODE SELECT	[00 1]	[00 1]	[00 1]	[00 1]
	④ PAN PARAMETER SET (see NOTE 2)	[C]	[C]	[C]	[C]
	⑤ AUX. OUT LEVEL	[000]	[000]	[000]	[000]
	⑥ NOTE DOUBLER	[000]	[000]	[000]	[000]
	⑦ DETUNE	[000]	[000]	[000]	[000]
	⑧ KEY SHIFT	[000]	[000]	[000]	[000]
	⑭ GLIDE ENABLE	[OFF]	[OFF]	[OFF]	[OFF]
	⑮ PITCH BEND RANGE (FVX-1)	[000]	[000]	[000]	[000]
⑯ VIBRATO CONTROL SELECT (FVX-1)	[OFF]	[OFF]	[OFF]	[OFF]	
Tone Group Data	⑨ KEY LIMIT (HIGH)	[C 7]	[C 7]	[C 7]	[C 7]
	⑩ KEY LIMIT (LOW)	[R _ 1]	[R _ 1]	[R _ 1]	[R _ 1]
	⑪ REGIST. CHANGE ENABLE	[0 0]	[0 0]	[0 0]	[0 0]
Unit Data	⑫ TUNING	[440] [. 0]			
	⑬ BULK DATA SELECT	[R L L]			
	⑮ KEY MODE SELECT (AVX-1)	[8] [8]			
	⑰ VOICE BANK SELECT (FVX-1)	[R]			
	⑳ USER VOICE AREA SELECT (FVX-1)	[1] [_ _] [124]			
	User voices [00 1–248]	The Preset voices [00 1–248] are copied			
	Common User voices [00 1–008]	The Preset voices [00 1–008] are copied			
	VIBRATO (see NOTE 3)	The Parameters characteristic to each Preset voice are set			
Program Effectors [PE 1–PE 4]	Reverbs 1–4 are set				

NOTES:

- For information on the default settings of the Effector Parameters, see “The Effector Parameters” on page 50.
- [000] is set as the AUTO mode speed, and [C _ 1] (Modulation Wheel) is set as the MANUAL mode controller.
- Because the Preset voices are copied to the User Voices, the Vibrato data for all voices are returned to their default settings. (For details on the Vibrato defaults for each voice, see “The Preset Voices” on page 44.)

The Effector Parameters

Effectors	Parameter No.								
	Parameter		1	2	3	4	5	6	7
SYMPHONIC	Parameter	PRESET MODE	—	—	—	—	—	—	—
	Variable Range	001-002	---	---	---	---	---	---	---
	Default	001	---	---	---	---	---	---	---
CELESTE	Parameter	PRESET MODE	—	—	—	—	—	—	—
	Variable Range	001-002	---	---	---	---	---	---	---
	Default	001	---	---	---	---	---	---	---
PHASER	Parameters	STAGE	—	FREQUENCY	DEPTH	FEEDBACK	—	—	—
	Variable Range	001-003	000-100	000-100	000-100	000-100	---	---	---
	Default	003	005	006	022	---	---	---	---
FLANGER	Parameters	DELAY TIME	DEPTH	FREQUENCY	FEEDBACK	DIRECT LEVEL	DELAY LEVEL	—	—
	Variable Range	000-100	000-100	000-100	000-100	000-100	000-100	000-100	---
	Default	009	048	004	051	080	064	---	---
DELAY	Parameters	DELAY TIME	DEPTH	FREQUENCY	FEEDBACK	DIRECT LEVEL	DELAY LEVEL	MODULATION WAVE	—
	Variable Range	000-100	000-100	000-100	000-100	000-100	000-100	001-002	---
	Default	100	012	008	061	080	034	002	---
WAH	Parameters	AUTO SPEED	CENTER FREQUENCY	DEPTH	—	—	—	—	—
	Variable Range	001-100	000-100	000-100	---	---	---	---	---
	Default	015	064	040	---	---	---	---	---
TREMOLO	Parameter	SPEED	—	—	—	—	—	—	—
	Variable Range	000-100	---	---	---	---	---	---	---
	Default	064	---	---	---	---	---	---	---
CHORUS	Parameter	—	—	—	—	—	—	—	—
	Parameter	DEPTH	—	—	—	—	—	—	—
REVERB 1-4	Parameter	DEPTH	—	—	—	—	—	—	—
	Variable Range	000-100	---	---	---	---	---	---	---
	Default	066	---	---	---	---	---	---	---

The Functions

No.	Function	Setting Unit	Variable Range
F 1	BRILLIANCE	Regist.	FVX-1: [-12] - [000] - [012] AVX-1: [-06] - [000]
F 2	TOUCH TONE RANGE	Regist.	[-15] - [000] - [015]
F 3	PAN MODE SELECT	Regist.	[001] (FIXED), [002] (AUTO), [003] (MANUAL), [004] (PRESET; FVX-1 only)
F 4	PAN PARAMETER SET	Regist.	FIXED Mode : [LLL] - [L] - [JJJ] AUTO Mode : [000] - [100] MANUAL Mode: [c_1] - [c_4]
F 5	AUX. OUT LEVEL	Regist.	[000] - [024]
F 6	NOTE DOUBLER	Regist.	[-36] - [000] - [036] (in half-steps)
F 7	DETUNE	Regist.	FVX-1: [-15] - [000] - [015] AVX-1: [-05] - [000] - [005]
F 8	KEY SHIFT	Regist.	[-12] - [000] - [012] (in half-steps)
F 9	KEY LIMIT (HIGH)	Tone Group	[R_1] - [C_7]
F 10	KEY LIMIT (LOW)	Tone Group	[R_1] - [C_7]
F 11	REGIST. CHANGE ENABLE	Tone Group	[0n] / [OFF]
F 12	TUNING	Unit	[433.5] - [440.0] - [446.4]
F 13	BULK DATA SELECT	Unit	[ALL], [REG], [JOC], [EFF]
F 14	GLIDE ENABLE	Regist.	[OFF] / [0n]
F 15	KEY MODE SELECT [AVX-1]	Unit	[8] [8] / [16] [0]
	PITCH BEND RANGE [FVX-1]	Regist.	[000] - [012] (in half-steps)
F 16	VIBRATO CONTROL SELECT [FVX-1]	Regist.	[OFF], [c_1], [c_2], [c_3]
F 17	VOICE COPY [FVX-1]	Unit	Tone Group 1: [R] / [b] Tone Group 2: [001] - [248] + [001] - [008] Tone Group 3: [---] Tone Group 4: [001] - [248] + [001] - [008]
F 18	VOICE EDIT [FVX-1]	Unit	Tone Group 1: [001] - [248] + [001] - [008] Tone Group 2: [001] / [002] + [0P1] - [0P8] Tone Group 3: [F], [UF], [OL], [R†], [RL], [d1†], [d1L], [d2†], [d2L], [††], [†L] Tone Group 4: [032], [016], [008], [004], [000] - [007] [000] - [255] [000] - [100] (→see page 36)
F 19	VOICE BANK SELECT [FVX-1]	Unit	Tone Group 4: [R] / [b]
F 20	USER VOICE AREA SELECT [FVX-1]	Unit	[1] [_ _ _] [124] / [125] [_ _ _] [248]

The MIDI Codes

■ Channel Messages

Code	Function	Transmitted	Recognized
8nH, nnH (Note No.), 00H-7FH	Note OFF	×	CHs 1—16
9nH, nnH (Note No.), 01H-7FH (ON) 00H (OFF)	Note ON/OFF	×	CHs 1—16
BnH, 01H, 00H-7FH	Modulation Wheel	×	CHs 1—16
BnH, 02H, 00H-7FH	Breath Control (FVX-1 only)	×	CHs 1—16
BnH, 04H, 00H-7FH	2nd Expression Pedal	×	CHs 1—16
BnH, 07H, 00H-7FH	Volume (Tone Group Level Control)	×	CHs 1—16
BnH, 0AH, 00H-7FH	Pan Control	×	CHs 1—16
BnH, 0BH, 00H-7FH	Expression Pedal	×	CHs 1—16
BnH, 40H, 7FH (ON)/00H (OFF)	Sustain	×	CHs 1—16
BnH, 7BH, 00H	All Notes OFF	×	CHs 1—16
CnH, 00H-0FH (Regist. No.)	Program Change	×	CHs 1—16
DnH, 00H-7FH	After Touch	×	CHs 1—16
EnH, 00H-7FH, 00H-7FH	Pitch Bender	×	CHs 1—16

nH=0H-FH (1—16 ch)

■ System Realtime Messages

Code	Function	Transmitted	Recognized
FEH	Active Sensing	○	○
FFH	Reset	×	○

■ System Exclusive Messages

Code	Function	Transmitted	Recognized
F0H, 43H, 70H, 70H, 01H, , F7H	Request-to-Send FM Voice Data	×	○
F0H, 43H, 70H, 70H, 02H, , F7H	Request-to-Receive FM Voice Data	×	○
F0H, 43H, 70H, 70H, 10H, F7H	Request-to-Send All RAM Data	×	○
F0H, 43H, 70H, 70H, 11H, F7H	Request-to-Send Regist. Data	×	○
F0H, 43H, 70H, 70H, 15H, F7H	Request-to-Send Effector Data	×	○
F0H, 43H, 70H, 70H, 16H, F7H	Request-to-Send FM User Voice Data	×	○
F0H, 43H, 70H, 70H, 20H, F7H	Request-to-Receive All RAM Data	×	○
F0H, 43H, 70H, 70H, 21H, F7H	Request-to-Receive Regist. Data	×	○
F0H, 43H, 70H, 70H, 25H, F7H	Request-to-Receive Effector Data	×	○
F0H, 43H, 70H, 70H, 26H, F7H	Request-to-Receive FM User Voice Data	×	○
F0H, 43H, 70H, 70H, 30H, F7H	Request-to-Send Model ID Data	×	○
F0H, 43H, 70H, 70H, 38H, 7FH, F7H 00H	Bulk Dump Acknowledge Bulk Dump Unacknowledge	×	×
F0H, 43H, 70H, 70H, 40H, 45H, 7FH, F7H 00H	Foot Switch Left ON OFF	×	○
F0H, 43H, 70H, 70H, 40H, 4FH, 00H-7FH, F7H	Master Volume	×	○
F0H, 43H, 70H, 70H, 70H, 10H(+), nnH*, F7H 11H(-)	Master Volume (*Only 01H is sent from MDR-2P)	×	○
F0H, 43H, 70H, nnH**, 00H, , F7H	Bulk Dump Data	○	○
F0H, 43H, 70H, nnH**, 00H, F7H	Model ID Data	○	×

**FVX-1=0FH; AVX-1=10H

FM VOICE EXPANDER FVX-1

MIDI Implementation Chart

Date: 9/1, 1987

Version: 1.0

Function		Transmitted	Recognized	Remarks
Basic Channel	Default	X	1-16 *	* Memory
	Changes	X	1-16 *	
Mode	Default	X	Mode 3	
	Messages	X	X	
	Altered	*****	X	
Note Number	True Voice	X	0-127	
		*****	21-108	
Velocity	Note ON	X	○ 9nH, v = 1-127	
	Note OFF	X	○ 9nH, v = 0, 8nH	
After Touch	Key's	X	X	
	Ch's	X	○	
Pitch Bender		X	○ 0-12 semi	7 bit resolution
Control Change	1	X	○	Modulation wheel Breath control 2nd Expression pedal Volume Pan control Expression pedal
	2	X	○	
	4	X	○	
	7	X	○	
	10	X	○	
	11	X	○	
	64	X	○	Sustain
Program Change	True #	X	○ 0-127	** Registration Memory
		*****	0-15 **	
System Exclusive		○	○	
System Common	Song Pos	X	X	
	Song Sel	X	X	
	Tune	X	X	
System Real Time	Clock	X	X	
	Commands	X	X	
Aux Messages	Local ON/OFF	X	X	
	All Notes OFF	X	○	
	Active Sense	○	○	
	Reset	X	○	
Notes				

Mode 1: OMNI ON, POLY
Mode 3: OMNI OFF, POLY

Mode 2: OMNI ON, MONO
Mode 4: OMNI OFF, MONO

○: YES
X: NO

AWM VOICE EXPANDER AVX-1

MIDI Implementation Chart

Date: 9/1, 1987

Version: 1.0

Function		Transmitted	Recognized	Remarks
Basic Channel	Default	X	1-16 *	* Memory
	Changes	X	1-16 *	
Mode	Default	X	Mode 3	
	Messages	X	X	
	Altered	*****	X	
Note Number		X	0-127	
	True Voice	*****	21-108	
Velocity	Note ON	X	○ 9nH, v = 1-127	
	Note OFF	X	○ 9nH, v = 0, 8nH	
After Touch	Key's	X	X	
	Ch's	X	○	
Pitch Bender		X	○ 0-12 semi	7 bit resolution
Control Change	1	X	○	Modulation wheel
	4	X	○	2nd Expression pedal Volume
	7	X	○	
	10	X	○	
	11	X	○	Pan control Expression pedal
	64	X	○	Sustain
Program Change	True #	X	○ 0-127 0-15 **	** Registration Memory

System Exclusive		○	○	
System Common	Song Pos	X	X	
	Song Sel	X	X	
	Tune	X	X	
System Real Time	Clock	X	X	
	Commands	X	X	
Aux Messages	Local ON/OFF	X	X	
	All Notes OFF	X	○	
	Active Sense	○	○	
	Reset	X	○	
Notes				

Mode 1: OMNI ON, POLY
Mode 3: OMNI OFF, POLY

Mode 2: OMNI ON, MONO
Mode 4: OMNI OFF, MONO

○: YES
X: NO

The Status Codes

- During any type of operation (mainly during data transfer), one of the Status Codes listed below may be shown at the Common Display. If so, refer to the table below to remedy the problem.
- To clear the Status Code display, either press the SHIFT/CONFIRM switch or one of the eight selector switches, or rotate one of the Tone Group DATA ENTRY switches.

Display	Code Description and Remedy
C01	The internal processing could not keep up with the speed of reception because an abnormally large number of MIDI Channel Messages were simultaneously received. (The sound will be stopped momentarily, then normal reception will be resumed.)
C02	The Bulk data sent from MDX-1 or other external device could not be received. Or, during Bulk data reception, Bulk data was sent in through another MIDI jack. Transmit the Bulk data again.
C03	Your unit is not properly connected to MBS-10 or MBS-10 is not being supplied with power. Check the connection and power supply, then repeat the To Pack or From Pack operation.
C04	The inserted RAM Pack does not contain the Voice Expander data, is of incompatible type, or is otherwise defective. Check the RAM pack, then repeat the From Pack operation.
C05	An error occurred during data transfer with MBS-10. Check the RAM Pack, the connection, your procedure, etc., then repeat the To Pack or From Pack operation.
C06	The AWM ROM DRAWER is not properly installed in the unit or the DRAWER is mounted with incompatible AWM Voice Packs. Turn OFF the unit's POWER switch, then check the status of the DRAWER and the Voice Packs.
C07	Voice data from an external device was sent in during a Voice Edit operation. (The Voice data from the external device is disregarded and not received.)

Specifications

	FVX-1	AVX-1
Tone Generator	FM Tone Generator (8 operators)	AWM Tone Generator
Soundable Range	A ₋₁ to C ₇ (88 keys)	A ₋₁ to C ₇ (88 keys)
Tone Group/Key Modes	4 Tone Groups/8-note polyphonic	2 Tone Groups/8-note polyphonic (or 1 Tone Group/16-note polyphonic)
No. of Voices	Max. 504 voices	Max. 8 voices
Tone Group Section	Switches DATA ENTRY × 4, MIDI ENABLE × 4 Displays Tone Group Display × 4, MIDI RECEIVE × 4	DATA ENTRY × 2, MIDI ENABLE × 2 Tone Group Display × 2, MIDI RECEIVE × 2
Common Section	Switches MIDI/FROM PACK, VOICE, LEVEL, SUSTAIN/TO PACK, REGIST +/ -, EFF. SEL./EFF. DEP., VIBRATO, FUNCTION +/ -, SHIFT/CONFIRM, MEMORY, COARSE Displays Common Display	MIDI/FROM PACK, VOICE, LEVEL, SUSTAIN/TO PACK, REGIST +/ -, EFF. SEL./EFF. DEP., OCT. SHIFT, FUNCTION +/ -, SHIFT/CONFIRM, MEMORY, COARSE Common Display
Main Controls/Others	POWER, Level Meter, MASTER VOLUME, REMOTE, Master AUX. VOLUME, HEADPHONES VOLUME	POWER, Level Meter, MASTER VOLUME, REMOTE, Master AUX. VOLUME, HEADPHONES VOLUME, AWM ROM DRAWER
I/O Jacks	HEADPHONES (phone), MIDI IN/OUT (front), MIDI IN/OUT/THRU (rear), PACK PORT, MAIN IN L/R (pin), AUX. IN L/R (pin), MAIN OUT L/R (pin), MAIN OUT L/R (phone), AUX. OUT L/R (pin), AUX. OUT L/R (phone)	HEADPHONES (phone), MIDI IN/OUT (front), MIDI IN/OUT/THRU (rear), PACK PORT, MAIN IN L/R (pin), AUX. IN L/R (pin), MAIN OUT L/R (pin), MAIN OUT L/R (phone), AUX. OUT L/R (pin), AUX. OUT L/R (phone)
Size (W × D × H)	480 × 383.5 × 88 mm	480 × 383.5 × 88 mm
Weight	7.2 kg	9 kg

Blank Copy of Registration Chart [FVX-1] (1)

*Make additional copies of this chart for your own use.

SONG NAME		TERMINAL No.		DATE	
MEMO					

		1	2	3	4	
MIDI	ENABLE	ON / OFF	ON / OFF	ON / OFF	ON / OFF	
	CH					
KEY LIMIT	HIGH (F 9)	(C7)	(C7)	(C7)	(C7)	
	LOW (F10)	(A-1)	(A-1)	(A-1)	(A-1)	
REGIST. CHANGE ENABLE (F11)		ON / OFF	ON / OFF	ON / OFF	ON / OFF	
VOICE BANK SELECT (F19)		A (Preset) / B (User)				
REGIST NUMBER No.	VOICE	NUMBER				
		NAME				
		VIB. DELAY				
		VIB. SPEED				
		VIB. DEPTH				
	VIB. CONTROL SELECT (F16)					
	LEVEL	MAIN				
		AUX. OUT (F 5)				
	PAN	MODE SEL. (F 3)				
		PRM. SET (F 4)				
	SUSTAIN					
	EFFECTOR	SELECT				
		PRM. 1				
		2				
		3				
		4				
		5				
		6				
		7				
	BRILLIANCE (F 1)					
TOUCH TONE RANGE (F 2)						
NOTE DOUBLER (F 6)						
DETUNE (F 7)						
KEY SHIFT (F 8)						
GLIDE ENABLE (F14)		OFF / ON	OFF / ON	OFF / ON	OFF / ON	
PITCH BEND RANGE (F15)						

Blank Copy of Registration Chart [FVX-1] (2)

*Make additional copies of this chart for your own use.

SONG NAME		TERMINAL No.		VOICE BANK	A (Preset) / B (User)	DATE															
	1	2	3	4																	
MIDI ENABLE	ON / OFF	ON / OFF	ON / OFF	ON / OFF																	
MIDI CH																					
REGIST. No.	VOICE	LEVEL	SUS.	EFFECTOR	OTHERS	VOICE	LEVEL	SUS.	EFFECTOR	OTHERS	VOICE	LEVEL	SUS.	EFFECTOR	OTHERS	VOICE	LEVEL	SUS.	EFFECTOR	OTHERS	
1																					
2																					
3																					
4																					
5																					
6																					
7																					
8																					
9																					
10																					
11																					
12																					
13																					
14																					
15																					
16																					

USED VOICE No.							
VOICE NAME							
VIBRATO DELAY							
SPEED							
DEPTH							
PAN MODE / SET							

<ul style="list-style-type: none"> ① BRILLIANCE ② TOUCH TONE RANGE ③ AUX. OUT LEVEL ④ NOTE DOUBLER ⑤ DETUNE ⑥ KEY SHIFT ⑦ GLIDE ENABLE ⑧ PITCH BEND RANGE ⑨ VIBRATO CONTROL SELECT 	<ul style="list-style-type: none"> ⓐ KEY LIMIT (HIGH) ⓑ KEY LIMIT (LOW) ⓒ REGIST. CHANGE ENABLE
---------------------------------------------------------------------------------------------------------------------------------------------------------------------------------------------------------------------------------------------------------------------------	----------------------------------------------------------------------------------------------------------------------------------

Blank Copy of Registration Chart [AVX-1] (1)

***Make additional copies of this chart for your own use.**

SONG NAME		TERMINAL No.		DATE	
MEMO					

			1	2
MIDI	ENABLE		ON / OFF	ON / OFF
	CH			
KEY LIMIT	HIGH (F 9)		(C7)	(C7)
	LOW (F10)	(A-1)		(A-1)
REGIST. CHANGE ENABLE (F11)			ON / OFF	ON / OFF
KEY MODE SELECT (F15)			8 × 2 / 16 × 2	
REGIST NUMBER	VOICE	NUMBER		
		NAME		
No.	LEVEL	MAIN		
		AUX. OUT (F 5)		
	PAN	MODE SEL. (F 3)		
		PRM. SET (F 4)		
SUSTAIN				
	EFFECTOR	SELECT		
		PRM. 1		
		2		
		3		
		4		
		5		
		6		
		7		
BRILLIANCE (F 1)				
TOUCH TONE RANGE (F 2)				
NOTE DOUBLER (F 6)				
DETUNE (F 7)				
KEY SHIFT (F 8)				
OCTAVE SHIFT				
GLIDE ENABLE (F14)			OFF / ON	OFF / ON

AWM ROM DRAWER								
SLOT NUMBER	1	2	3	4	5	6	7	8
VOICE								

Blank Copy of Registration Chart [AVX-1] (2)

*Make additional copies of this chart for your own use.

SONG NAME	TERMINAL No.	KEY MODE SELECT	8 X 2 / 16 X 1	DATE
-----------	--------------	-----------------	----------------	------

		1				2							
		ON / OFF				ON / OFF							
MIDI ENABLE	MIDI CH	VOICE	LEVEL	SUS.	EFFECTOR	OCT. S.	FUNCTION	VOICE	LEVEL	SUS.	EFFECTOR	OCT. S.	FUNCTION
REGIST. No.	1												
	2												
	3												
	4												
	5												
	6												
	7												
	8												
	9												
	10												
	11												
	12												
	13												
	14												
	15												
	16												

USED VOICE No.			
VOICE NAME			
PAN MODE / SET			
	<ul style="list-style-type: none"> ① BRILLIANCE ② TOUCH TONE RANGE ③ ACX. OUT LEVEL ④ NOTE DOUBLER ⑤ DETUNE ⑥ KEY SHIFT ⑦ GLIDE ENABLE 	<ul style="list-style-type: none"> ⑧ KEY LIMIT HIGH ⑨ KEY LIMIT LOW ⑩ REGIST. CHANGE ENABLE 	

Blank Copy of Voice Editing Chart [FVX-1]

*Make additional copies of this chart for your own use.

VOICE NAME	ALGORITHM No.	VOICE No.
------------	---------------	-----------

OPERATOR	FEET	WAVE FORM	OUTPUT LEVEL	ENVELOPE GENERATOR								
				AR	AL	DIR	DIL	DZR	DZL	RR	RL	
OP 1												
OP 2												
OP 3												
OP 4												
OP 5												
OP 6												
OP 7												
OP 8												

VOICE NAME	ALGORITHM No.	VOICE No.
------------	---------------	-----------

OPERATOR	FEET	WAVE FORM	OUTPUT LEVEL	ENVELOPE GENERATOR								
				AR	AL	DIR	DIL	DZR	DZL	RR	RL	
OP 1												
OP 2												
OP 3												
OP 4												
OP 5												
OP 6												
OP 7												
OP 8												

VOICE NAME	ALGORITHM No.	VOICE No.
------------	---------------	-----------

OPERATOR	FEET	WAVE FORM	OUTPUT LEVEL	ENVELOPE GENERATOR								
				AR	AL	DIR	DIL	DZR	DZL	RR	RL	
OP 1												
OP 2												
OP 3												
OP 4												
OP 5												
OP 6												
OP 7												
OP 8												

FCC INFORMATION (USA)

While the following statements are provided to comply with FCC Regulations in the United States, the corrective measures listed are applicable worldwide.

This equipment use frequencies that appear in the radio frequency range, and if installed in the immediate proximity of some types of audio or video devices within three meters (approximately ten feet), interference may occur.

This equipment has been type-tested and found to comply with the specifications set for a class B computer in accordance with those specifications listed in sub-part J, part 15 of the FCC rules. These rules are designed to provide a reasonable measure of protection against such interference. However, this does not guarantee that interference will not occur.

If this equipment should be suspected of causing interference with other electronic devices, verification can be made by turning this equipment off and on. If the interference continues when this equipment is off, this equipment is not the source of the interference. If this equipment does appear to be the source of the interference, you should try to correct the situation by using one or more of the following measures:

- Relocate either this equipment or the electronic device that is being affected by the interference.
- Utilize power outlets for this equipment and the device being affected that are on different branch (circuit breaker or fuse) circuits, or install AC line filters.
- In the case of radio-TV interference, relocate the antenna or if the antenna lead-in is 300 ohm ribbon lead, change the lead-in to coaxial type cable.

If these corrective measures do not produce satisfactory results, please contact an authorized Yamaha Electone™ dealer for suggestions and/or corrective measures. If you can not locate an authorized Yamaha Electone™ dealer in your general area, please contact the Electone™ Service Department, YAMAHA MUSIC CORP, U.S.A. 6600 Orangethorpe Ave., Buena Park, CA 90620.

If for any reason, you should need additional information relating to radio or TV interference, you may find a booklet prepared by the Federal Communications Commission Helpful: "How to Identify and Resolve Radio-TV Interference Problems." This booklet, Stock #004-000-00345-4, is available from the US. Government Printing Office, Washington DC. 20402.

YAMAHA
YAMAHA CORPORATION
P.O.Box 1, Hamamatsu, Japan

This file has been downloaded from:

www.UsersManualGuide.com

User Manual and User Guide for many equipments like mobile phones, photo cameras, mother board, monitors, software, tv, dvd, and othes..

Manual users, user manuals, user guide manual, owners manual, instruction manual, manual owner, manual owner's, manual guide, manual operation, operating manual, user's manual, operating instructions, manual operators, manual operator, manual product, documentation manual, user maintenance, brochure, user reference, pdf manual