

OPERATING AND INSTALLATION MANUAL

**ZANUSSI**

**BUILT-IN OVEN  
MODEL  
ZBF 760**

# Important Safety Information



**These warnings are provided in the interest of safety. You MUST read them carefully before installing or using the appliance. Your safety is of paramount importance. If you are unsure about any of the meanings of these WARNINGS, contact the Customer Care Department**

## Installation

- The oven must be installed according to the instructions supplied. Any electrical work must be undertaken by a qualified electrician/competent person.
- This oven is heavy and care must be taken when moving it. Do not try to move the appliance by pulling the door handle.
- Remove **all packaging**, both inside and outside the oven, before using the appliance. After installation, please dispose of the packaging with due regard to safety and the environment.
- **It is dangerous** to alter the specifications or modify the appliance in any way.

## During Use

- This oven has been designed for cooking edible foodstuffs only and **must not** be used for any other purposes.
- Never line any part of the oven with **aluminium foil**. Do not allow heatproof cooking material, e.g. roasting bags, to come into contact with oven elements.
- **Never** place plastic or any other material which may melt in or on the oven.
- **Do not** place sealed cans or aerosols inside the oven. They may explode if they are heated.
- **Do not** hang towels, dishcloths or clothes from the oven or its handle. They are a **safety hazard**.
- **Do not** use this oven if it is in contact with water and never operate it with wet hands.
- **Always cook with the oven door closed.**
- Use any oven proof cookware which will withstand temperatures of 250°C.
- Take **great care** when heating fats and oils as they will ignite if they become too hot.
- **Always** use oven gloves to remove and replace food in the oven. Similarly always use oven gloves to remove and replace the grill pan handle, before and after grilling.
- **Always** remove the grill pan handle when grilling.
- Ensure that you **support** the grill pan when removing it from the oven.
- **Take care** to follow the recommendations given for tending the food when grilling.
- **Always** stand back from the oven when opening the oven door, to allow any build-up of steam or heat to release.
- Stand clear when opening the drop down oven door. **Do not** allow it to fall open - support the door using the door handle, until it is fully open.

- Ensure that the anti-tip oven shelves are installed in the correct way (see instructions).
- Ensure that all control knobs are in the **OFF** position when not in use.
- **Do not** leave cookware containing foodstuffs, e.g. fat or oil in or on the oven in case it is inadvertently switched **ON**.
- When using other electrical appliances, ensure the cable does not come into contact with the hot surfaces of the cooking appliance.

## Child Safety

- This appliance is designed to be operated by adults and children under supervision. Young children **must not** be allowed to tamper with the controls or play near or with the appliance.
- Accessible parts, especially around the grill area, become hot when the cooker is in use. Children should be **kept away** until it has cooled.

## Maintenance and Cleaning

- **Only** clean this oven in accordance with the instructions.
- The oven should be kept clean at all times. A build-up of fats or other foodstuffs could result in a fire, especially in the grill pan.
- Always allow the cooling fan to cool the oven down before switching off at the electrical supply prior to carrying out any cleaning or maintenance work.

## Service

- You must not attempt to repair the appliance yourself. Repairs carried out by inexperienced persons may cause injury or serious malfunctioning. Refer to your local Zanussi Service Force Centre. Always insist on genuine Zanussi spare parts.

## Disposal of an old appliance

- Make the appliance unusable, by cutting off the cable, and remove any door catches, to prevent small children being trapped inside

It is most important that this instruction book should be retained with the appliance for future reference. Should the appliance be sold or transferred, always ensure that the book is left with the appliance in order that the new owner can get to know the functions of the appliance and the relevant warnings.

# Contents

## For the User

<b>Important safety information</b>	<b>Page 3</b>
<b>Description of the appliance</b>	<b>Page 5</b>
<b>Controls</b>	<b>Page 6</b>
<b>The Electronic Timer</b>	<b>Page 7</b>
<b>Before the First Use</b>	<b>Page 9</b>
<b>Using the Fan Oven</b>	<b>Page 9</b>
<b>Cooking Chart</b>	<b>Page 11</b>
<b>Defrosting</b>	<b>Page 13</b>
<b>Grilling</b>	<b>Page 14</b>
<b>Cleaning the Oven</b>	<b>Page 15</b>
<b>What happens if something goes wrong</b>	<b>Page 18</b>
<b>Service and Spare Parts</b>	<b>Page 19</b>
<b>Peace of Mind for 24 months</b>	<b>Page 19</b>

## For the Installer

<b>Technical Data</b>	<b>Page 20</b>
<b>Electrical Connection</b>	<b>Page 20</b>
<b>Installation</b>	<b>Page 21</b>

## Guide to Use the instructions

The following symbols will be found in the text to guide you throughout the Instructions:



Safety Instructions



Step by step instructions for an operation



Hints and Tips



Environmental information

**CE** This appliance complies with the following E.E.C. Directives:



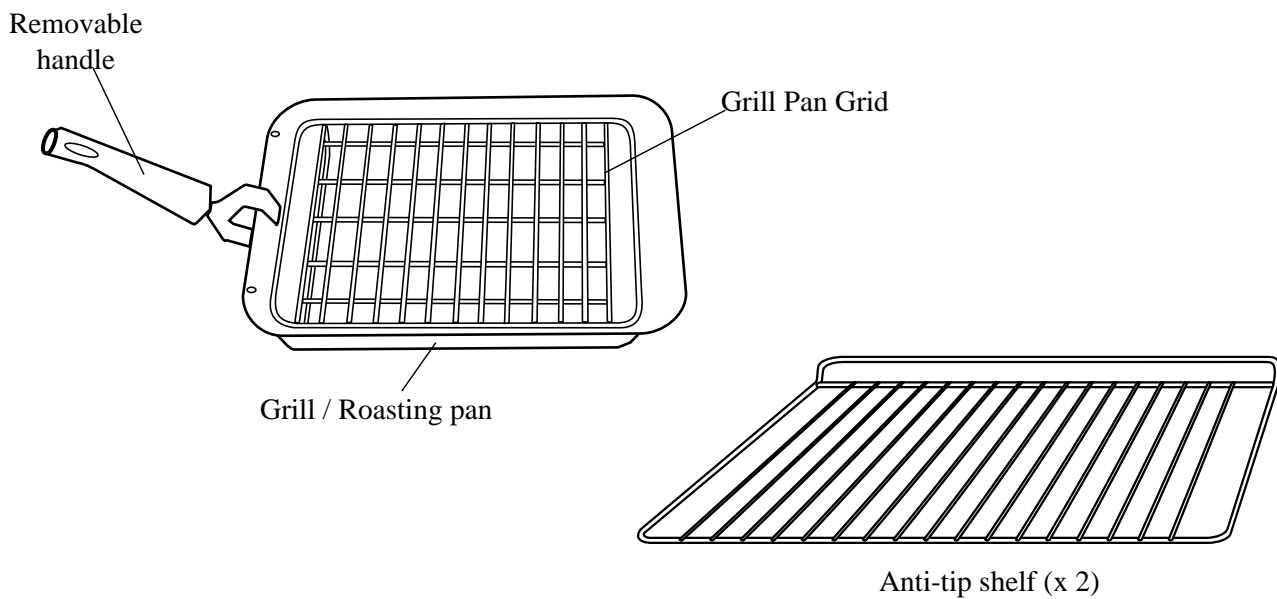
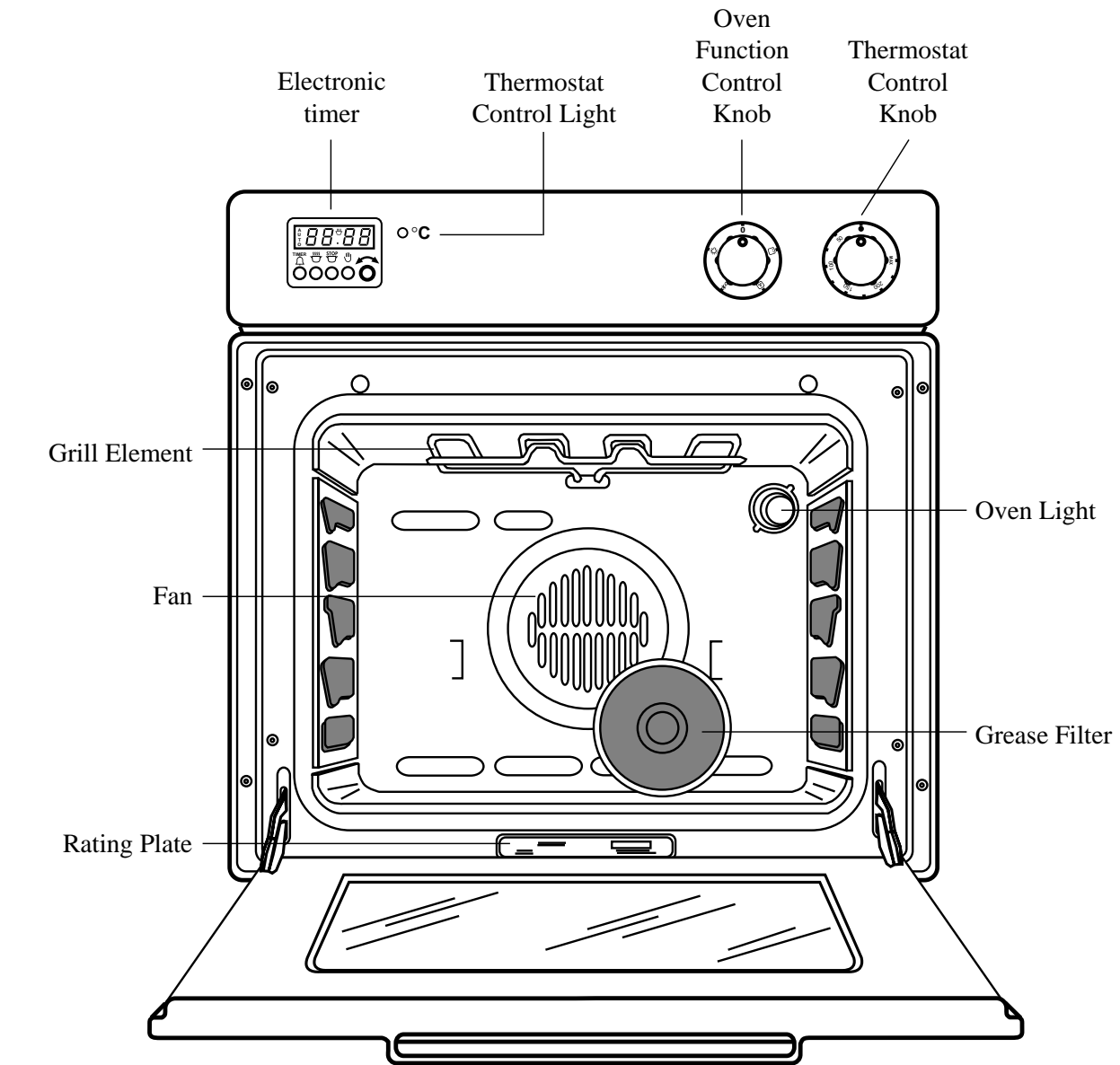

- \* **73/23 - 90/683**  
(Low Voltage Directive);
- \* **93/68** (General Directives);
- \* **89/336** (Electromagnetic Compatibility Directive) .  
and subsequent modifications

# Description of the Appliance



# Controls

## Oven Function Control Knob

-  Oven Light - The oven light will be on without any cooking function.
-  Defrost Setting - This setting is intended to assist in thawing of frozen food (see page 13).
-  Fan ducted cooking - This allows you to roast or roast and bake simultaneously using any shelf, without flavour transference.
-  Grill - The heat comes only from the top element.

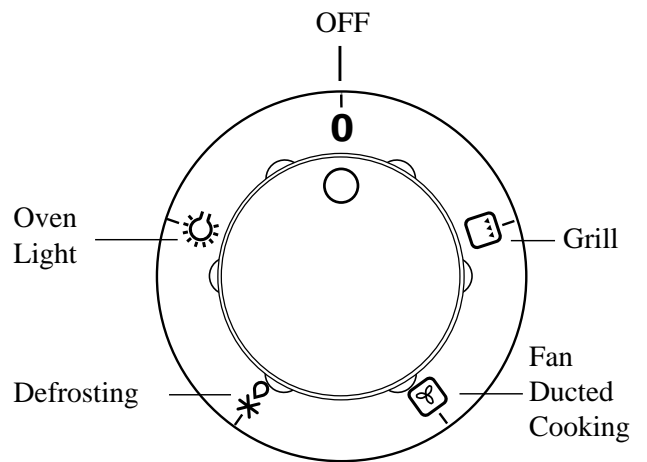





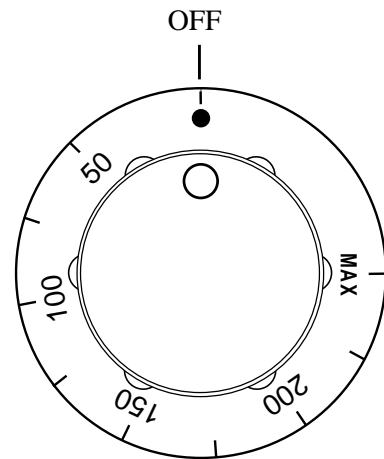

## Thermostat Control Knob

Turn the thermostat control knob clockwise to select temperatures between 50°C and 250°C (MAX).



## Electronic Timer

-  Minute minder
-  Cooking duration
-  End of cooking time
-  Manual function
-  Cookpot symbol - This will be displayed when a program is in operation.
-  Auto symbol - This will be displayed when the oven has been programmed for automatic operation.

 Time setting knob

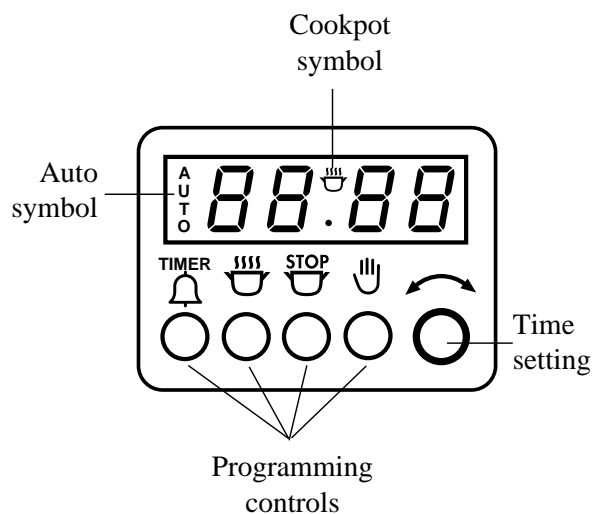

# The Electronic Timer



The electronic timer can indicate the time of day, operate as a minute minder and automatically operate the oven.

Before the oven can be operated, the time of day must be set on the electronic timer.

Please note that this is a 24 hour clock. For example, 2pm is shown as 14:00.

In case of loss of power, all the settings (time of day, set program or program in operation), will be cancelled. When the power is restored, the numbers on the display will flash, and the timer has to be reset.

## **TO SET THE TIME OF DAY**

Press buttons  and , and at the same time turn the time setting knob until the correct time of day is displayed.

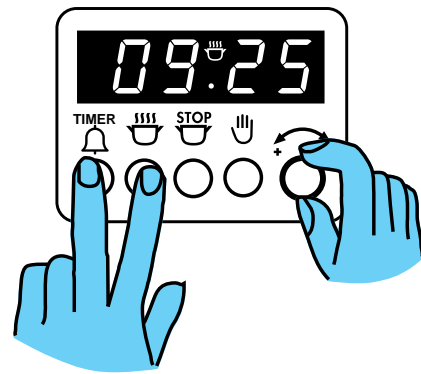



## **TO SET THE MINUTE MINDER**

Press button  and at the same time turn the setting time knob until the duration time is displayed (maximum 23 hours, 59 minutes).

Our diagram shows the timer set for 45 minutes.

After a few seconds the time of day will show in the display.

To check the number of minutes remaining, press the  button. At the end of the timed period an alarm will sound. To switch off the alarm press button .

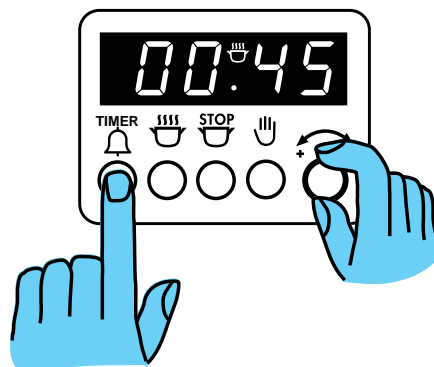

## **MANUAL FUNCTION**

Press button  to set the oven for manual function.

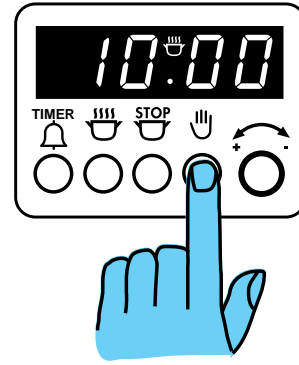

## **TO SET THE TIMER TO SWITCH OFF ONLY**

This is useful if you want to begin cooking immediately but have the oven switch off automatically.

1. Set the oven function control knob and the thermostat control knob on the required settings.
2. Place food in the oven.
3. Press button  and, at the same time, turn the time setting knob until the required cooking duration is displayed.

Our diagram shows the timer set for 1 hour 10 minutes.

At the end of the cooking time the oven will switch off, an alarm will sound. To switch off the alarm press button .

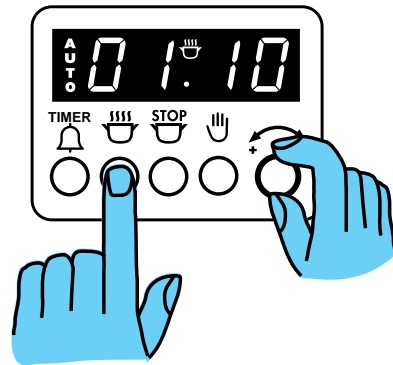



## **TO SET THE TIMER TO SWITCH THE OVEN ON AND OFF**

1. Ensure the clock is showing the right time of day.
2. Carry out steps 1, 2 and 3 as explained in "To set the timer to switch off only".
3. Press button  and at the same time turn the time setting knob until the end cooking time is displayed.

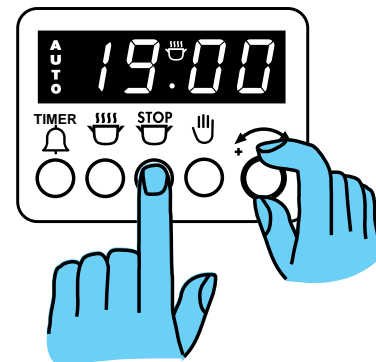
Our diagram show the end cooking time set for 7pm.



## **TO CANCEL A PROGRAMME**

1. Press button  and, at the same time, turn the time setting knob until the cooking duration is set on "zero".
3. If the end cooking time has been set too, press button  and at the same time turn the time setting knob until the end cooking time is set on "zero".

# Before the First Use



Remove **all packaging**, both inside and outside the oven, before using the appliance.

Before first use, the oven should be heated without food. During this time, an unpleasant odour may be emitted. This is quite normal.



1. Set the electronic timer to manual function.
2. Switch the oven function control knob to fan cooking .
3. Set the thermostat control knob to MAX.
4. Open a window for ventilation.
5. Allow the oven to run empty for approximately 45 minutes.

This procedure should be repeated with the grill  function for approximately 5-10 minutes.

## Using the Fan Oven

The air inside the oven is heated by the element around the fan situated behind the back panel. The fan circulates hot air to maintain an even temperature inside the oven.

**The advantages of cooking with this function are:**

### ✓Faster Preheating

As the fan oven quickly reaches temperature, it is not usually necessary to preheat the oven although you may find that you need to allow an extra 5-7 minutes on cooking times. For recipes which require higher temperatures, best results are achieved if the oven is preheated first, e.g. bread, pastries, scones, souffles, etc.

### ✓Lower Temperatures

Fan oven cooking generally requires lower temperatures than conventional cooking. Follow the temperatures recommended in the chart at page. 11 or remember to reduce temperatures by about 20-25°C for your own recipes which use conventional cooking.

### ✓Even Heating for Baking

The fan oven has uniform heating on all runner positions. This means that batches of the same food can be cooked in the oven at the same time. However, the top shelf may brown slightly quicker than the lower one.

This is quite usual. There is no mixing of flavours between dishes.

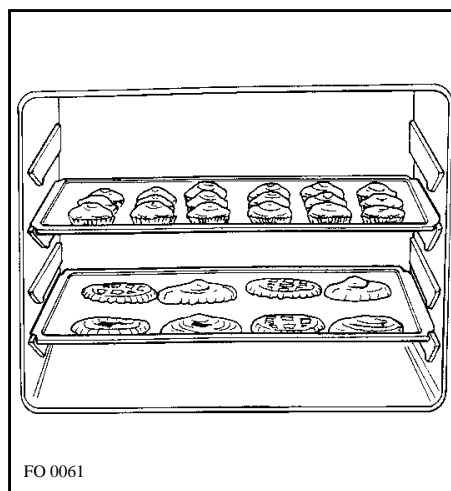

FO 0061



The oven has four shelf levels, and is supplied with two anti-tip shelves.

It is important that these shelves are correctly positioned as shown in the diagram.

## How to Use the Fan Oven

1. Turn the oven function control knob to .
2. Turn the thermostat control to the required temperature.

### THINGS TO NOTE

- The oven light will come on when the oven function control knob is set.
- The oven fan will operate continually during cooking.
- The thermostat control light will remain on until the correct temperature is reached. It will then cycle on and off to show the temperature is being maintained.

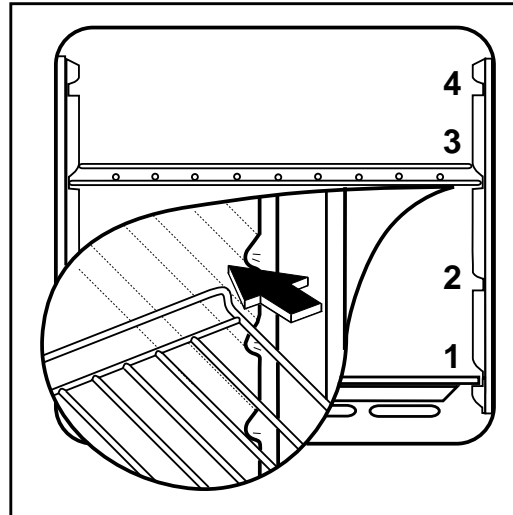

### Condensation and steam

When food is heated it produces steam in the same way as a boiling kettle. The oven is vented to allow some of this steam to escape. However, always stand back from the cooker when opening the oven door to allow any build up of steam or heat to release.

If the steam comes into contact with a cool surface on the outside of the oven, e.g. a trim, it will condense and produce water droplets. This is quite normal and is not caused by a fault on the oven.

To prevent discolouration, regularly wipe away condensation and also soilage from surfaces.

### The cooling fan

During cooking the cooling fan will cycle ON and OFF. This is quite normal.

It may run on after the oven is switched off to keep the controls cool.

### NOTE

The action of the cooling fan will depend on how long the oven has been used and at what temperature. It may not switch in at all at lower temperature settings nor run on where the oven has only been used for a short time.

# Cooking Chart

This chart is intended as a guide only. It may be necessary to increase or decrease the temperature to suit your individual requirements. Only experience will enable you to determine the correct setting for your personal requirements.

Food	Shelf Position	Cooking Temp (°C)
Biscuits		180-190
Bread		210-220
Casseroles		130-140
Cakes: Small and queen	Shelf positions are not critical but ensure that oven shelves are evenly spaced when more than one is used.	160-170
Sponges		160-170
Madeira		140-150
Rich Fruit		130-140
Christmas		130-140
Meringues		90-100
Fish		170-190
Fruit Pies and Crumbles		190-200
Milk Puddings		130-140
Pastry: Choux } Shortcrust } Flaky } Puff }		190-200
Plate Tarts		180
Quiches/Flans		170-180
Scones		210-220
Roasting: Meat & Poultry		160-180

When roasting, ensure the meat is cooked thoroughly, use a meat thermometer if preferred to check the centre temperature has reached the required temperature (see table below).

MEAT	TEMPERATURES
Beef	Rare - 60°C Medium - 70°C Well Done - 80°C
Pork	Well Done - 80°C
Lamb	Medium - 70°C Well Done - 80°C

## Cookware

Baking trays, oven dishes, etc. should not be placed directly against the grid covering the fan at the back of the oven, or placed on the oven base.

Do not use baking trays larger than 30 cm x 35 cm (12 in x 14 in) as they will restrict the circulation of heat and may affect performance.

## The effects of dishes on cooking results

Dishes and tins vary in their thickness, conductivity, colour, etc. which affects the way they transmit heat to the food inside them:

- A** Aluminium, earthenware, oven glassware and bright shiny utensils reduce cooking and underneath browning.
- B** Enamelled cast iron, anodized aluminium, aluminium with non-stick interior and coloured exterior and dark, heavy utensils increase cooking and underneath browning.

## **i** Hints and Tips

Runner positions are not critical, but make sure the shelves are evenly spread.

When cooking more than one dish in the fan oven, place dishes centrally on the shelves rather than several dishes on one shelf.

When the oven is full, you may need to allow slightly longer cooking time.

A shelf may be placed on the floor of the oven. Place dishes on a shelf in this position rather than on the oven base, to allow air circulation around the food.

When the oven is full of the same food, e.g. equal trays of small cakes or equal size victoria sandwich cakes, then they will be cooked in the same time and removed from the oven together. When different sizes of trays or types of food, e.g. biscuits and cakes are cooked, they will not necessarily be ready together.

The fan oven can be used to heat foods through without thawing first, e.g. fruit tarts, mince pies, sausage rolls, and other small pastry items. Use a temperature of 190-200°C and allow 20-40 minutes (depending on the quantity of food in the oven).

The use of too high temperatures can cause uneven browning. Check with the recommendations for oven temperatures given in the cooking charts, but be prepared to adjust the temperature by 10°C if necessary. Remember to reduce temperatures by about 20-25°C for your own conventional recipes.

When roasting do use the trivet in the meat tin. Fat and meat juices will drain into the meat tin below and can be used to make gravy. The trivet also prevents splashes of fat from soiling the oven interior.

The meat tin **should not** be placed on a heated hotplate as this may cause the enamel to crack.

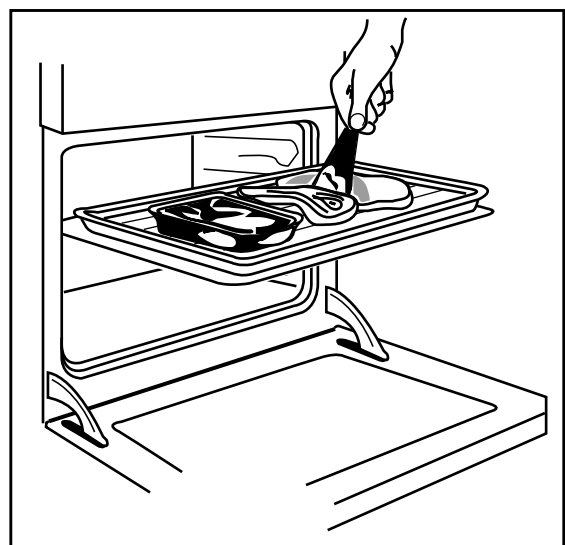
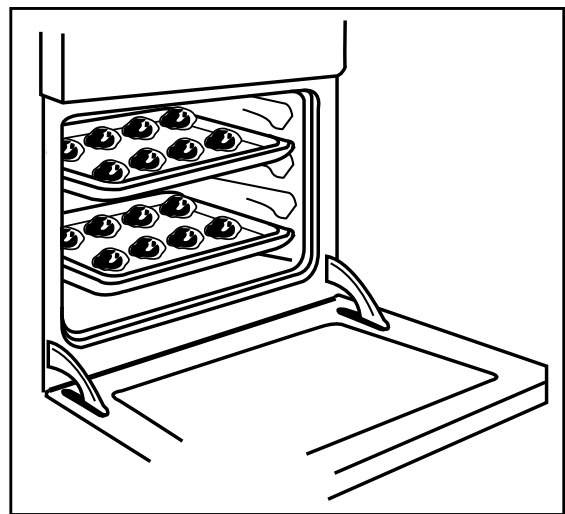

# Defrosting

The oven fan operates without heat and circulates the air, at room temperature, inside the oven. This increases the speed of defrosting. However, please note that the temperature of the kitchen will influence the speed of defrosting.

This function is particularly suitable for delicate food which could be damaged by heat, e.g. cream filled gateaux, iced cakes, pastries, bread and other yeast products.

## How to Use Defrosting

1. Turn the oven function control knob to .
2. Ensure the thermostat control knob is in the OFF position.

## Hints and Tips

- Cover food with a lid, aluminium foil or plastic film to prevent drying out during defrosting.
- ALWAYS COOK THOROUGHLY IMMEDIATELY AFTER THAWING.
- Frozen food should be placed in a single layer when ever possible and turned over half way through the defrosting process.
- Only joints of meat and poultry up to 2 kg. (4 lb.) are suitable for defrosting in this way.

Refer to the following table for approximate defrosting times.

Food	Defrosting time (Mins)	Standing time (Mins)	Notes
Chicken 1000 g.	100-140	20-30	Place the chicken on an inverted saucer on a large plate. Defrost open and turn at half time or defrost covered with foil. Remove giblets as soon as possible.
Meat 1000 g.	100-140	20-30	Defrost open and turn at half time or cover with foil
Meat 500 g.	90-120	20-30	As above
Trout 150 g.	23-35	10-15	Defrost open
Strawberries 300 g.	30-40	10-20	Defrost open
Butter 250 g.	30-40	10-15	Defrost open
Cream 2 x 200 g.	80-100	10-15	Defrost open (cream is easy to whip even if parts of it are still slightly frozen)
Cake 1400 g.	60	60	Defrost open

The times quoted in the chart should be used as a guide only, as the speed of defrosting will depend on the kitchen temperature. For example, the colder the ambient temperature, the longer the defrosting time.

# Grilling



Grilling must be carried out with the oven door closed. The grill pan handle must be removed from the pan.

## How to Use the Grill

1. Turn the oven control function knob on .
2. Turn the thermostat control knob on the required temperature.
3. Adjust the grid and grill pan runner position to allow for different thicknesses of food. Position the food close to the element for faster cooking and further away for more gentle cooking.

Preheat the grill on a full setting for a few minutes before sealing steaks or toasting. Adjust the heat setting and the shelf as necessary, during cooking

During cooking, the cooling fan and the thermostat control light will operate in the same way as described for the fan oven function.

## Hints and Tips

- Most foods should be placed on the grid in the grill pan to allow maximum circulation of air to lift the food out of the fats and juices. Food such as fish, liver and kidneys may be placed directly on the grill pan, if preferred
- Food should be thoroughly dried before grilling to minimise splashing. Brush lean meats and fish lightly with a little oil or melted butter to keep them moist during cooking
- Accompaniments such as tomatoes and mushrooms may be placed underneath the grid when grilling meats
- When toasting bread, we suggest that the top runner position is used with the grid in its 'high' position
- The food should be turned over during cooking, as required.

The grill element is controlled by the thermostat. During cooking, the grill cycles on and off to prevent overheating.

## COOKING CHART

Cooking time depends on the thickness of the meat and not on its weight.

Type of food	Mins per side	
Bacon rashers	2 - 5	
Chicken joints	15 - 20	
Gammon rashers	5 - 8	
Lamb chops	6 - 12	
Pork chops	10 - 15	
Sausages (turning as required)	10 - 12	
Steaks (average thickness)	Rare	3 - 6
	Medium	6 - 10
	Well done	8 - 12
Toast	1 - 1½	

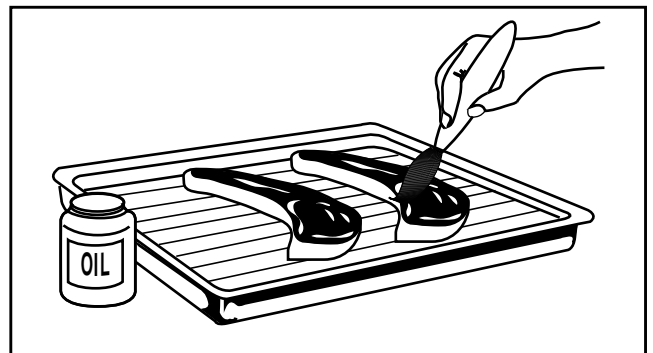

# Cleaning the Oven



Before cleaning always allow the cooling fan to cool the cooker down before switching off at the electricity supply.

The oven should be kept clean at all times. A build-up of fats or other foodstuffs could result in a fire, especially in the grill pan.

## Cleaning materials

Before using any cleaning materials on your oven, check that they are suitable and that their use is recommended by the manufacturer.

Cleaners that contain bleach should NOT be used as they may dull the surface finishes. Harsh abrasives should also be avoided.

## External cleaning

Regularly wipe over the control panel, oven door and door seal using a soft cloth well wrung out in warm water to which a little liquid detergent has been added.



To prevent damaging or weakening the door glass panels avoid the use of the following:

- Household detergent and bleaches
- Impregnated pads unsuitable for non-stick saucepans
- Brillo/Ajax pads or steel wool pads
- Chemical oven pads or aerosols
- Rust removers
- Bath/Sink stain removers

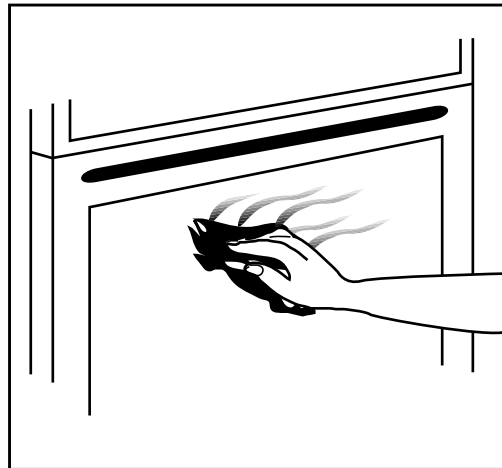

Clean the outer and inner door glass using warm soapy water. Should the inner door glass become heavily soiled it is recommended that a cleaning product such as Hob Brite is used.



DO NOT clean the oven door while the glass panels are warm. If this precaution is not observed the glass panel may shatter.



If the door glass panel becomes chipped or has deep scratches, the glass will be weakened and must be replaced to prevent the possibility of the panel shattering. Contact your local Service Centre who will be pleased to advise further.

## Oven Cavity

The enamelled oven cavity is best cleaned whilst the oven is still warm.

Wipe the oven over with a soft cloth soaked in warm soapy water after each use. From time to time it will be necessary to do a more thorough cleaning, using a proprietary oven cleaner.

If the soilage has become set, after the oven has cooled down, the following process will help to soften the splatters to help make cleaning easier.

-  1. Place the grill/ meat pan on the oven shelf positioned in the lowest runner.
2. Add a few drops of washing-up liquid to the pan and fill to about 12 mm. with boiling water from the kettle.
3. Close the oven door, turn the oven function knob on fan oven  and set the thermostat knob on 50°C.
4. After 15 minutes, turn off the thermostat and allow the fan oven to continue without heat for a further 5 minutes, when the temperature of the water will have cooled down.
5. Carefully remove the pan of water from the oven and use normal oven cleaners to clean away soil residues.
6. Leave a little of soapy water to soak into any burned on spillage on the floor of the oven for a longer time if necessary.

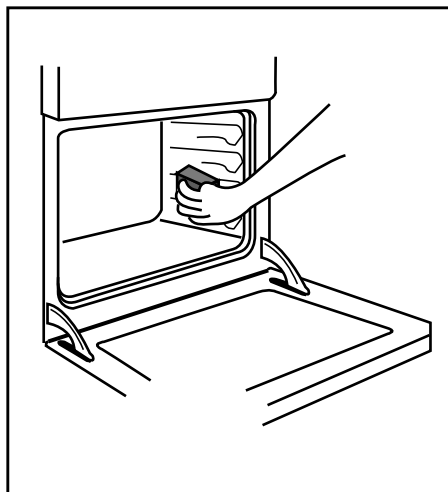

## Oven Shelves

To clean the oven shelves, soak in warm soapy water and remove stubborn marks with a well wetted soap impregnated pad. Rinse well and dry with a soft cloth.

## Grease Filter

To prevent a build-up of fats on the fan impellor, the grease filter must be fitted by clipping it over the vents in the back panel. Do not use abrasive materials to clean the seal. The grease filter is dishwasher proof.

### To clean the grease filter

When cooking is completed and the oven has cooled down, remove the filter by pushing the protruding tongue on the filter upward, and wash carefully. Remember to refit the filter before using the oven again.

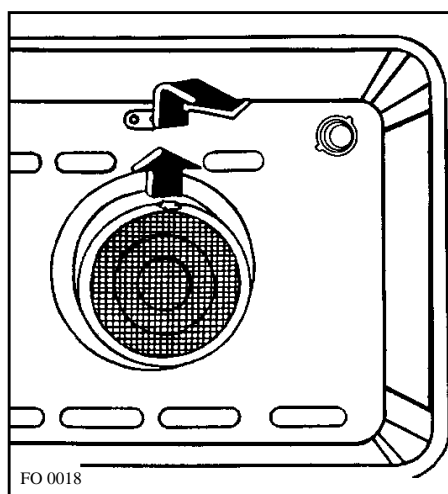

## Replacing The Oven Light

If the oven bulb needs replacing, it must comply with the following specifications:

- Electric power: 15W,
- Electric rate: 220-240 V (50 Hz),
- Resistant to temperatures of 300°C,
- Connection type: E14.

These bulbs are available from your local Zanussi Force Service Centre.

To replace the faulty bulb:

1. Ensure the oven is isolated from the electrical supply.
2. Push in and turn the glass cover anticlockwise.
3. Remove the faulty bulb and replace with the new one.
4. Refit the glass cover.
5. Restore the electrical supply.

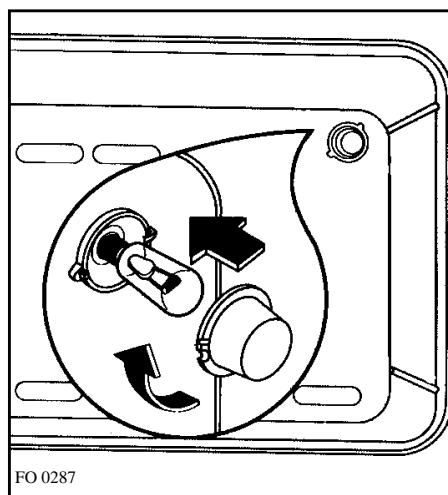



# If something goes wrong

If the appliance is not working correctly, please carry out the following checks, before contacting your local Zanussi Service Centre.

SYMPTOM	SOLUTION
<ul style="list-style-type: none"> <li>■ The oven does not come on</li> </ul>	<ul style="list-style-type: none"> <li>◆ Check the oven is in manual operation and that both a cooking function and temperature have been selected.</li> <li>◆ Check the appliance is wired in properly, and the socket switch or the switch from the mains supply to the oven are ON.</li> </ul>
<ul style="list-style-type: none"> <li>■ The oven temperature light does not come on</li> </ul>	<ul style="list-style-type: none"> <li>◆ Select a temperature with the thermostat control knob</li> <li>◆ Select a function with the oven function control knob.</li> </ul>
<ul style="list-style-type: none"> <li>■ The oven light does not come on</li> </ul>	<ul style="list-style-type: none"> <li>◆ Select a function with the oven function control knob</li> <li>◆ Check the light bulb, and replace it if necessary (see "Cleaning the Oven")</li> </ul>
<ul style="list-style-type: none"> <li>■ It takes too much time to finish the dishes, or they are cooked too fast.</li> </ul>	<ul style="list-style-type: none"> <li>◆ The temperature may need adjusting</li> <li>◆ Refer to the contents of this booklet, especially to the chapter "Using the Oven".</li> </ul>
<ul style="list-style-type: none"> <li>■ Steam and condensation settle on the food and the oven cavity.</li> </ul>	<ul style="list-style-type: none"> <li>◆ Leave dishes inside the oven no longer than 15-20 minutes after the cooking is completed. See page 10</li> </ul>
<ul style="list-style-type: none"> <li>■ The timer does not work</li> </ul>	<ul style="list-style-type: none"> <li>◆ Check the instructions for the timer.</li> </ul>
<ul style="list-style-type: none"> <li>■ The oven fan is noisy</li> </ul>	<ul style="list-style-type: none"> <li>◆ Check the grease filter is correctly fitted.</li> <li>◆ Check that shelves and bakeware are not vibrating in contact with the oven back panel.</li> </ul>

If after all these checks, the oven still does not work, contact your local Zanussi Service Force Centre quoting your model and serial number, which can be found on the rating plate.

Please note that it will be necessary to provide proof of purchase for any in-guarantee service calls.

**In-guarantee customers should ensure that the above checks have been made as the engineer will make a charge if the fault is not a mechanical or electrical breakdown.**

# Service and Spare Parts

If you require spare parts or an engineer contact your local Service Force Centre by telephoning:

**0990-929929**

For further details, please see the accompanying Customer Care Booklet.

## **CUSTOMER CARE DEPARTMENT**

For general enquiries concerning your Zanussi appliance, contact our Customer Relations Department by letter or telephone as follows:

Customer Care Department  
Zanussi House  
Hambridge Rd.  
Newbury  
Berks RG14 5EP  
Tel: 01635 - 521313

# Peace of Mind for Twenty Four Months

## **ZANUSSI GUARANTEE CONDITIONS**

This guarantee is in addition to your statutory and other legal rights

We, Zanussi Ltd., undertake that, if, within twenty four months of the date of the purchase, this ZANUSSI appliance or any part thereof is proved to be defective by reason only of faulty workmanship or materials, we will, at our option, repair or replace the same **FREE OF ANY CHARGE** for labour, materials or carriage on condition that:

- \* The appliance has been correctly installed and used on the electricity supply stated on the rating plate.
- \* The appliance has been used for normal domestic purposes only, and in accordance with the manufacturer's operating and maintenance instructions.
- \* The appliance has not been serviced, maintained, repaired, taken apart or tampered with by any person not authorised by us.

All service work under this guarantee must be undertaken by a Zanussi Service Force Centre.

Home visits are made between 8.30 am and 5.30 pm Monday to Friday.

Visits may be available outside these hours in which case a premium will be charged.

Any appliance or defective part replaced shall become our property.

## **EXCLUSIONS**

**This guarantee does not cover:**

- \* Damage or calls resulting from transportation, improper use or neglect, the replacement of any light bulbs or removable parts of glass or plastic.
- \* Costs incurred for calls to put right machines improperly installed or calls to machines outside the UK and the Republic of Ireland.
- \* Appliances found to be in use within a commercial or similar environment, plus those which are subject to rental agreements.
- \* Products of Zanussi manufacture which are **NOT** marketed by Zanussi Ltd.
- \* EEC Countries - The standard guarantee is applicable but subject to the owner's responsibility and cost to ensure the appliance meets the standards set by the country to which the product is taken. The Zanussi Company in the country concerned will be pleased to advise further. Sight of your purchase receipt will be required by them.

# Technical Data

<b>DIMENSIONS OF RECESS</b>	Height	580 mm.
	Width	560-570 mm.
	Depth	550 mm.

<b>DIMENSIONS OF THE OVEN CAVITY</b>	Height	320 mm.
	Width	420 mm.
	Depth	390 mm.
	Oven capacity	53.2 litres

## Heating elements rating

Oven element	2.5 kW
Grill element	1.8 kW
Convection Fan	30 W
Oven Light	15 W
Cooling Fan	25 W
<b>Total Rating</b>	<b>2.570 kW</b>

# Electrical Connection



We strongly recommend that all operations for the installation of your cooker be carried out by **QUALIFIED PERSONNEL** to the relevant British Standards.

The oven is designed to be connected to 240V (50Hz) electricity supply.

The oven has an easily accessible terminal block which is marked as follows:

- Letter L - Live terminal
- Letter N - Neutral terminal
-  - Earth terminal

### THIS APPLIANCE MUST BE EARTHED

The cable used to connect the oven to the electrical supply must comply to the specifications given below.

### For Uk use only

Models	Rating	Cable cross section mm <sup>2</sup> and Type of the cable	Fuse min.
ZBF 760	2570 W	6 mm <sup>2</sup> 6242 Y	15 A

### For Europe use only

Models	Rating	Cable cross section mm <sup>2</sup> and Type of the cable	Fuse min.
ZBF 760	2570 W	2,5 mm <sup>2</sup> Ho5 RR-F	13 A

It is necessary that you install a double pole switch between the appliance and the electricity supply (mains), with a minimum gap of 3mm between the switch contacts and of a type suitable for the required load in compliance with the current rules.

The switch must not break the yellow and green earth cable at any point.

### Important

After installation and connecting, the cable must be placed so that it cannot at any point reach a temperature of more than 50°C above the ambient temperature.

Before the appliance is connected, check that the main fuse and the domestic installation can support the load; and that the power supply is properly earthed.

The manufacturer disclaims any responsibility should these safety measures not be carried out.

# Installation



The oven must be installed according to the instructions supplied. Any electrical work must be undertaken by a qualified electrician/competent person, in accordance with existing rules and regulations.

**It is dangerous** to alter the specifications or modify the appliance in any way.

Please ensure that when the appliance is installed it is easily accessible for the engineer in the event of a breakdown.

## BUILDING IN

The surround or cabinet into which the oven will be built must comply with these specifications:

- the dimensions must be as shown in the relevant diagrams;
- the materials must withstand a temperature increase of at least 60°C above ambient;
- proper arrangements must be made of a continuous supply of air to the oven to prevent the oven overheating.

Dimensions of the appliance and recess required are given in the relevant diagrams.

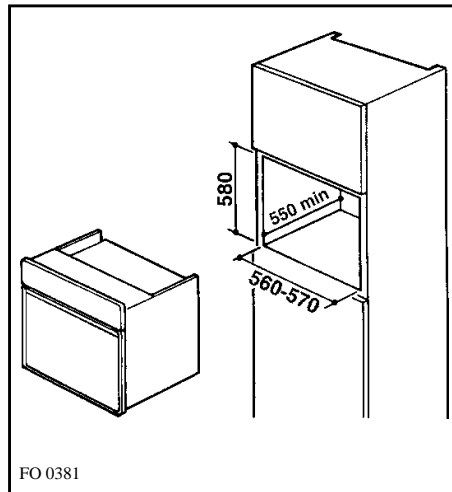
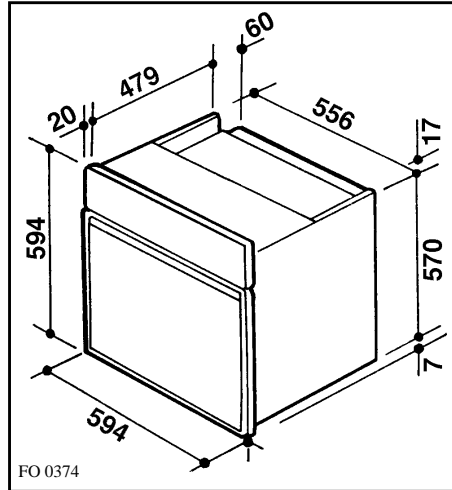

## Securing The Oven To The Cabinet

1. Fit the appliance into the cabinet recess,
2. Open the oven door
3. Secure the oven to the kitchen cabinet with four wood screws, which fit the holes provided in the oven frame.

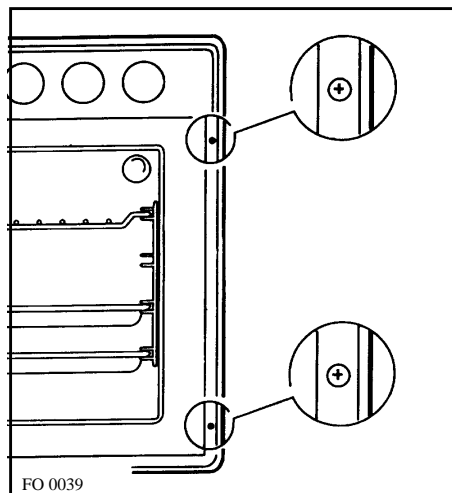

**This file has been downloaded from:**

[www.UsersManualGuide.com](http://www.UsersManualGuide.com)

User Manual and User Guide for many equipments like mobile phones, photo cameras, mother board, monitors, software, tv, dvd, and othes..

Manual users, user manuals, user guide manual, owners manual, instruction manual, manual owner, manual owner's, manual guide, manual operation, operating manual, user's manual, operating instructions, manual operators, manual operator, manual product, documentation manual, user maintenance, brochure, user reference, pdf manual