

LAVATHERM 56600

Condenser Dryer

Operating Instructions

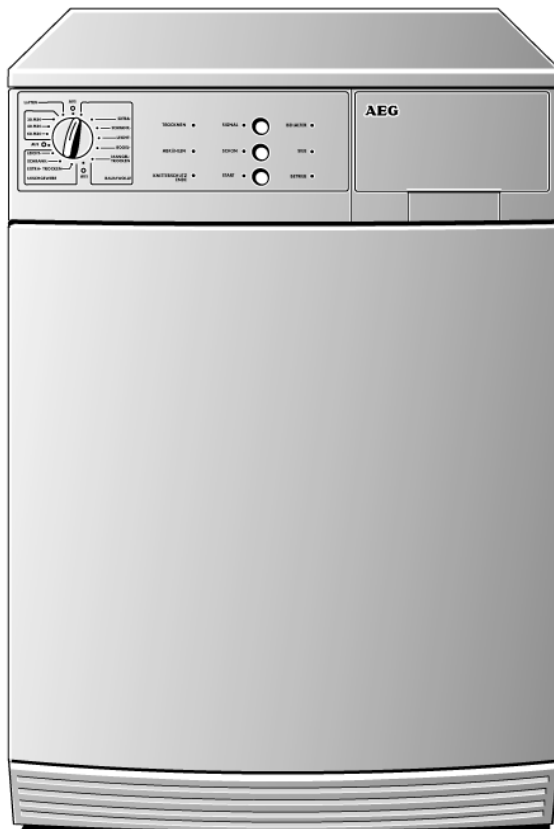

Dear customer,

Please read these operating instructions through carefully, before using the appliance.

Please ensure you fully understand the safety instructions on the first pages of these operating instructions! Retain this instruction book for future reference, and pass on to any future owners.



The warning triangle and/or the key words (**Warning!**, **Caution!**, **Important!**), emphasize information which is important for your safety or the correct functioning of the appliance. It is essential that this information is observed.



This symbol guides you step by step when operating the appliance.



This symbol gives additional information and practical tips on using the appliance.



Tips and information about the economical and environmentally friendly use of the machine are marked with the clover symbol.

If you require assistance or advice on your appliance, please contact our Customer Care Department by letter or telephone:

AEG Domestic Appliances Limited
55-77 High Street
Slough
Berkshire SL 1 1DZ
Tel: 08705 350350

Printed on environmentally friendly paper ...
Whoever thinks ecologically also acts ecologically.

Content

Important Safety Information	5
General Safety	5
Installation	6
Child Safety	6
General Information	7
Disposal	8
Packaging	8
Tumble Dryer	8
Environmental protection tips	9
Description of the appliance	11
Front view	11
Control panel	12
The program selector positions	13
Before using the appliance for the first time	13
Brief operating instructions	14
Drying	15
Prepare the laundry	15
Open the door	15
Load the laundry	15
Select the drying program	15
Start the drying program	16
Removing laundry or loading laundry when necessary	17
End of the drying process	17
Removing the laundry	17
Switch-off the dryer	17
Empty the water reservoir	18
Clean the fluff filter	19
Cleaning the condenser	19
Program tables	20
A small glossary of textile information	22
Care symbols	22
Cleaning and maintenance	23
Cleaning the filter area	23

Cleaning the drum 23

Cleaning the panel and operating parts 23

Cleaning the condenser 24

Something not working? 25

 Replace the interior light 27

Door Reversal Instructions 28

Technical data 30

Electrical Connection 31

Special accessories 33

 Drainage kit 33

 Stacking kit 33

Guarantee Conditions 34

Service & Spare Parts 36

Index 37

Important Safety Information

Your safety is of paramount importance, please ensure you read these warnings before installing or using the appliance. If you are unsure about any of the meanings of these warnings, contact the Customer Care Department.

General Safety

- This appliance is designed to dry normal domestic laundry. If the appliance is used for any other purpose or is incorrectly used, the manufacturer accepts no liability for any damages which may result.
- Switch off the appliance and isolate from the mains supply before carrying out any maintenance or cleaning work.
- Never operate the appliance if the mains cable is damaged or if the control panel, work top or base area are damaged allowing internal components to be accessible.
- Do not spray the tumble dryer with water.
- Do not dry textiles which have been treated with flammable cleaning agents and solvents.
- Clothes or articles of laundry which are dripping wet should not be placed in the dryer. Only load well-spun laundry.
- Laundry items containing sponge rubber or rubber-like materials must not be dried in the tumble dryer.
- If the drying cycle is interrupted, the laundry or drum may be hot.
- Do not use the tumble dryer without the bulb cover in position.
- Do not operate the appliance with a damaged filter or with no filter at all.
- Do not overload the appliance.
- It is dangerous to alter the specifications or attempt to modify this product in any way.
- Do not use the mains cable to pull the plug out of the socket.
- Repairs to the appliance should only be carried out by qualified personnel. Repairs carried out by inexperienced persons may cause injury or serious malfunction. Contact your local AEG Service Force Centre for repair.
- Adaptors and extension cables must not be used. There is risk of fire because of overheating!

- Washing that is in poor condition (heavily worn) and items with loose fillings (cushions) that could break open must not be dried or aired. There is a risk of fire!
- Washing with rigid components (foot mats) will cover the air slots; the slots will also be covered if the drum is overfilled. Observe the maximum load of 5 kg. There is a risk of overheating which could cause a fire!
- Only dry washing that does not contain any explosive objects (fire lighters, spray cans). There is a risk of fire or an explosion!

Installation

- Check the appliance for transportation damage before installation.
- Any electrical work required to install this appliance should be carried out by a qualified electrician or competent person.
- Do not install the appliance on deep pile carpet.
- Ensure the appliance is level.
- If the tumble dryer is installed next to a fuel burning stove, a heat insulation non-flammable pad must be inserted between the fuel burning stove and the tumble dryer; (dimensions 85 x 57.5 cm).

Child Safety

- The appliance is designed to be operated by adults. Children should not be allowed to tamper with the controls or play with the appliance.
- Pets and children have been known to climb into tumble dryers. Please check the drum before use.
- Keep all packaging away from children.
- When disposing of the appliance, cut off the mains cable and destroy the plug. Disable the door catch to prevent young children being trapped inside.

i General Information

- To prevent creasing do not exceed the maximum load stated in the program table.
- If using fabric conditioning sheets, we recommend the conditioning sheet is pinned (using a safety pin) to an article of laundry and placed in the tumble dryer.
- When using fabric conditioning sheets or drying starched washing in the tumble dryer, it is important to clean the drum to prevent a build up of any residues/deposits on the sensors. See maintenance and cleaning section.
- Please ensure the appliance is easily accessible to an engineer after installation.
- In the case of washer / dryer tower combinations, do not place any objects on the dryer during use as they could drop down.



Disposal

Packaging

- Dispose of the packaging material correctly. All packaging materials are environmentally friendly and can be disposed of without any danger to the environment.
- The external plastic covering and bags inside are made of Polyethylen (marking >PE<).
- The padding is made of CFC free expanded polystyrene (marking >PS<).

Tumble Dryer

When disposing of the tumble dryer.

- Cut off the mains cable and destroy the plug.
- Disable the door catch to prevent young children becoming trapped inside.
- Use an authorised disposal site.

The materials can be recycled in accordance with their markings. Standard tools (crosshead screwdriver, hammer) are sufficient to dismantle the old appliance.



Environmental protection tips

- Your laundry will become light and soft in the laundry dryer even without a soft rinsing agent.
- Loosen your laundry before loading it into the dryer. This helps to prevent lengthy running times and creasing. Ensure your laundry is well spun.

In the following table we give an overview of specific electric consumption data depending on the spinning speed. This information is valid for 5kg laundry dried with the program COTTONS CUPBOARD DRY:

Pre-drying:			Drying process:	
Revolutions per minute	Residual moisture		Required time in minutes	Power consumption in kWh
	in Litres	in %		
800	3.5	70	90	3.5
1000	3.0	59	85	3.0
1200	2.7	53	75	2.7
1400	2.5	50	70	2.6
1600	2.2	44	65	2.5

- Observe the maximum load instructions. Whenever possible, dry full loads.
- Choose the right drying program for the type and quantity of laundry. The dryer will then operate as economically as possible. Some typical consumption values:

Drying program	Fill weight in kg	Duration in Minutes	Power consumption in kWh
COTTONS CUPBOARD DRY ¹	5	90	3.5
COTTONS HAND IRON ¹	5	70	2.8
EASY CARES CUPBOARD DRY ²	2.5	35	1.3

1) spun at 800 revolutions per minute

2) spun at 1000 revolutions per minute

If the amount of laundry is not enough for a particular degree of drying (e.g. HAND IRON), you should dry it in stages for best economy: Fill the dryer and select the program HAND IRON; after the end of this program take out your laundry for ironing. Finally dry the remaining laundry with the program CUPBOARD DRY.

- Only use the SPECIAL CARE button for loads up to 2.5kg!
- Clean the fluff filter after every drying program!
- Empty the water reservoir after every drying program!



Caution! The condensed water is not suitable for drinking or for use with foodstuffs.

You can use the collected condensed water as distilled water in the household, but first pour it through a paper filter bag.

- Clean the condenser regularly. The dryer will operate more economically if you clean the condenser regularly.

Description of the appliance

Front view

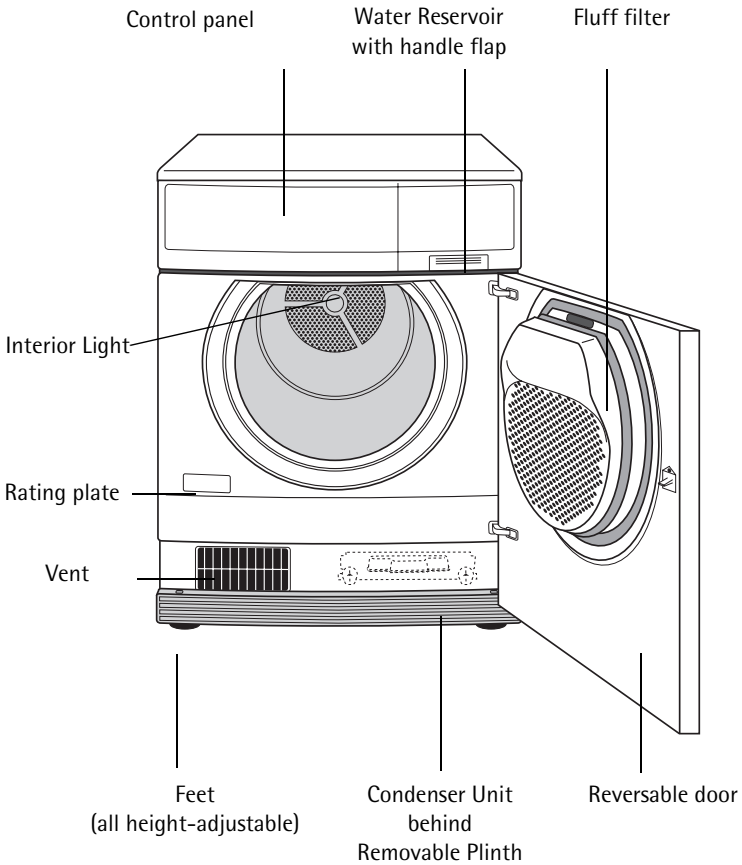

Control panel

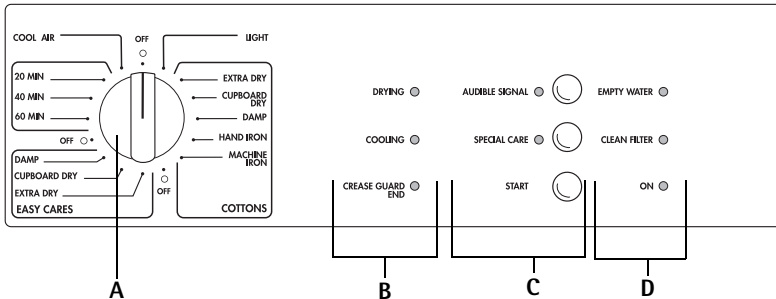

A Program selector: To select the drying program

B Program phase display: The current phase of the drying process is indicated.

C Pushbuttons

- AUDIBLE SIGNAL button: When switched-on, an audible signal is sounded at the end of the drying program
- SPECIAL CARE button: For delicate fabrics
- START button: Starts the program

D Display light:

- EMPTY WATER light: Empty the water reservoir!
- FILTER light: Clean the fluff filter
- OPERATING light: Illuminates when the appliance is switched on.

Note:

The indicators are extinguished only after the programme is switched off.

The program selector positions

- **OFF:**
The tumble dryer is switched off.
- **LIGHT:**
The drum light switches on when the door is opened.
- **Program group COTTON:**
Programs for drying cotton and linen fabrics;
maximum load 5 kg.
- **Program group EASY CARES:**
Programs for drying mixed fabrics and synthetics;
maximum load 2.5 kg.
- **Time programs:**
For additional drying or for drying loads of less than 1 kg.
- **COOL AIR Program:**
For smoothing creases in cold air;
Slightly moisten the creased articles;
Program duration: 10 minutes.

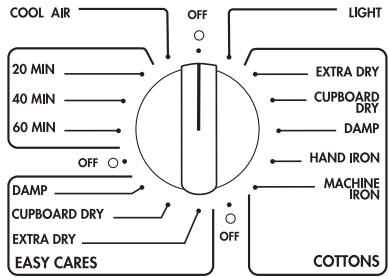

Before using the appliance for the first time

- ☞ Wipe the drum of the dryer with a moist cloth.

Brief operating instructions

- Ensure the laundry is well spun before tumble drying.
- Prepare the laundry.
- Load the laundry.
- Select the drying program on the program selector.
 - Press the SPECIAL CARE or AUDIBLE SIGNAL button if required?
- Start the program.

While the program is running you can open the door to take-out laundry or add more laundry.

At the end of the program :

- Remove the laundry.
- Clean the fluff filter.
- Switch-off the dryer.
- Empty the water reservoir.
- Check to see if the condenser needs cleaning.

Drying

Prepare the laundry

- To prevent tangled bundles of laundry: Close zip fasteners; button-up bed linen and pillow cases; tie-together loose tapes, e.g. aprons.
- Empty all pockets.
- Remove all metal objects (i.e. paper clips, pins, etc.).
- Turn clothing consisting of double-layer fabric inside out (such as cotton-lined anoraks with the cotton layer facing outwards). The fabrics will dry better.
- Loosen the laundry.

Open the door

To open the door:

- Press firmly against the door (Press position ).

Load the laundry



Caution! Ensure the laundry does not get caught in the door when the door is closed! This could damage the laundry!

- Load the prepared laundry into the dryer.

Select the drying program



Select the suitable drying program using the program selector (see "Program tables").

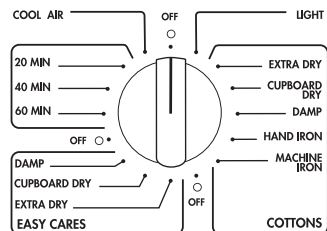

If required, select the buttons AUDIBLE SIGNAL or SPECIAL CARE.



- **AUDIBLE SIGNAL** button
During the crease-protection phase (immediately after the drying phase), an acoustic signal is sounded at intervals (see "End of drying process").
- **SPECIAL CARE** button
This program operates with reduced heat. Press the SPECIAL CARE button for fabrics bearing the care symbol . Gentle drying is advisable for heat-sensitive fabrics (such as acrylic and viscose).

Start the drying program

 Press the START button.

The drying program starts.
The program progress is indicated on program phase display.





Removing laundry or loading laundry when necessary

You can interrupt the drying process at any time to remove some of the laundry or to add more laundry.

 Open the door.

 **Caution!** The laundry and the drum may be hot.

 Remove or add more laundry.

 Close the door.

 Press the START button to resume the drying process.

End of the drying process

The **cooling phase** starts shortly before the end of the drying process: The heater is switched-off during this phase.

After the cooling phase you can remove the laundry from the dryer.

The **crease guard phase** follows automatically after the drying process. The drum rotates intermittently. This keeps your laundry loose and crease-free.

If you have pressed the AUDIBLE SIGNAL button, an acoustic signal is sounded intermittently during this phase.

Removing the laundry

 Open the door and remove the laundry.

Switch-off the dryer

 Turn the program selector to the OFF position.

Empty the water reservoir



Caution! The condensed water is not suitable for drinking or for use with foodstuffs.

The water reservoir should be emptied after every drying programme. This avoids interruption of a programme when the water reservoir is full.



Grasp the handle flap of the water reservoir and pull-out completely.

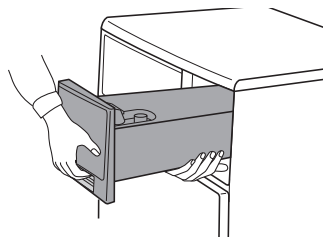

Push the cover of the water reservoir to the side and pour-out the condensed water.

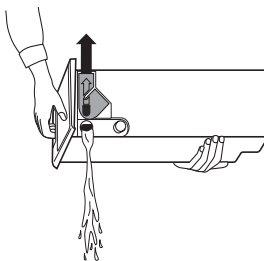

Re-insert the water reservoir into the control panel.

Information on illumination of the EMPTY WATER display:

The EMPTY WATER display remains illuminated for a few seconds more after the condensation container is emptied.



If the drying cycle has not yet ended:

Press the START button to continue the drying cycle.



The water reservoir has a capacity of approx. 3.8 litres. This is sufficient for a laundry load of 5 kg which has been machine spun at 800 revolutions per minute.

Clean the fluff filter

To ensure efficient operation of the tumble dryer, clean the fluff filter after each drying program. Also check whether there are any remnants or fluff from the washing in the drum; remove immediately.

- ✎ Press the catch of the filter lid downwards.

The filter lid will open.

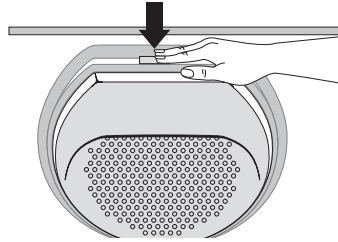

- ✎ Take-out the fluff filter.

- ✎ Remove fluff out of the fluff filter, with a moistened hand.

- ✎ Re-insert the fluff filter.

- ✎ Press against the filter lid until it catches into the locking device.

- ⓘ The filter lid cannot catch shut without the fluff filter in place and the door cannot be closed.

- ⚠ **Warning!** The dryer must not be operated with a damaged or blocked fluff filter!

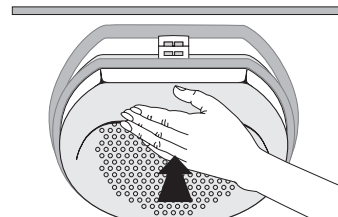
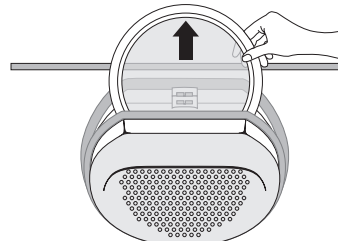



Cleaning the condenser

- ⚠ **Important!** It is essential to clean the condenser unit approx. after thirty drying programs. Otherwise your dryer might suffer damage. In addition, energy consumption is increased when the condenser unit is covered with fluff.

- ✎ See the section "Cleaning and maintenance, cleaning the condenser".

Program tables

Program group COTTONS

care symbols , ; maximum load 5 kg

Program	Laundry Type	Examples for
EXTRA DRY	Heavy weight or mult-layered fabrics	Towelling material, bath robes
CUPBOARD DRY	Fabrics of medium weight, articles not made up of mult-layers	Towel laundry, hand towels
DAMP	Lightweight materials requiring ironing	Cotton shirt and underwear
HAND IRON	Normal cotton and linen articles	Sheets and pillowcases, tablecloths
MACHINE IRON	Cotton and linen articles, to be ironed by rotary ironer or starched laundry	Cotton sheets and pillowcases, tablecloths

Program group EASY CARES

care symbols , ¹, ; maximum load 2.5 kg

Program	Laundry Type	Examples for
EXTRA DRY	Heavy weight or mult-layered fabrics	Sweatshirts, bed linen and table linen
CUPBOARD DRY	Lightweight materials which do not require ironing	Easycare fabric shirts, table linen, baby clothes, socks and underwear
DAMP	Lightweight synthetics and cotton/polyester mixtures requiring ironing	Bed and table linen, easycare fabric shirts and blouses

1) Press the SPECIAL CARE button!

TIME programs**care symbols , ¹, ; loads less than 1 kg**

You can select 20, 40 and 60 minutes program duration for additional drying of individual pieces of laundry or to dry small quantities.

1) Press the SPECIAL CARE button!





COOL AIR Program

The laundry is treated for 10 minutes in cold air; for smoothing creased clothing.

A small glossary of textile information

Care symbols

Ensure articles to be dried are suitable for tumble drying. If they are one of the following symbols should be present on the care label:

-  Normal drying
-  Drying with special care (press the SPECIAL CARE button!)
-  This fabric can be tumble dried. The fabric manufacturer does not stipulate if the piece of laundry should be dried on a normal or gentle program.
-  Do not tumble dry

If you do not find any of these care symbols:

Dry whites and coloureds as well as mixed fabrics at normal temperature. Press the SPECIAL CARE button if you are drying delicate fabrics.

- Wool
Do not dry any woollen items in the dryer.
- Fabrics sensitive to temperatures
Dry fabrics sensitive to temperatures (such as acrylic or viscose) and textiles with the care label  with the SPECIAL CARE button selected.
- Cotton jersey and hosiery have a tendency to shrink! Do not dry these fabrics excessively.
- New coloured textiles
To avoid the possibility of dye transference do not dry new coloured textiles together with light-coloured laundry.

Cleaning and maintenance

Cleaning the filter area

! **Important!** When the FILTER display lights, it is essential to clean the fluff filter. Otherwise your dryer might suffer damage. A small amount of fluff may reach the area around the filter in spite of the fluff filter. Therefore you should clean the entire filter area from time to time, or at least every three months.

- ☞** Remove the fluff filter.
- ☞** Hold the filter lid by the top and pull it forwards until it is released from both holders.
- ☞** Remove the fluff from the entire filter area – preferably with a vacuum cleaner.
- ☞** Press both pins of the filter lid into the holders on the door until they click in.
- ☞** Reinsert the fluff filter.
- ☞** Press against the filter lid until it clicks into the lock.

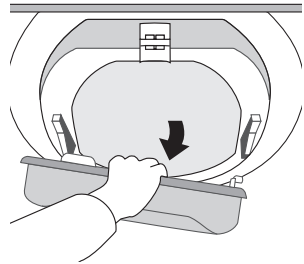

Cleaning the drum

- !** **Warning!** Do not clean the stainless steel drum with abrasive detergents or steel wool!
- ☞** Wipe the inside of the drum and the drum fins with white vinegar to avoid any residues/deposits effecting the sensors. This is particularly important if you regularly use fabric conditioning sheets or dry starched items in the dryer.

Cleaning the panel and operating parts

- !** **Warning!** Do not use household furniture polish or aggressive detergents.
- ☞** Wipe over the panel and operating parts with a damp cloth. Only use warm water.

Cleaning the condenser

 **Important!** The condenser unit must be cleaned after every thirty drying programs to ensure correct operation of the dryer and prevent any damage being caused. In addition energy consumption will be increased if the condenser unit is covered with fluff.

 Open the door.

 Press on the two tabs to unlatch and take off the removable plinth.

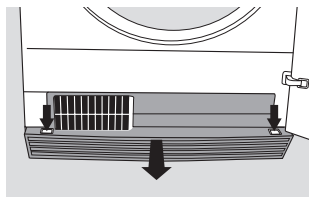

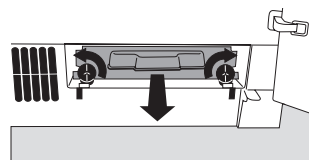

 Turn the two securing disks through a quarter turn each outwards.

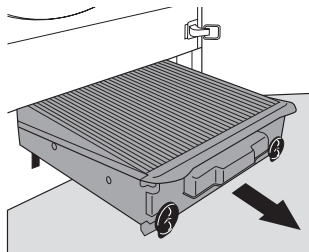

 Pull the condenser out of the base by the handle.

 Clean the condenser, best with a hand-held brush or by rinsing with a hand-held shower head. The water removal slits on the rear of the condenser must be free too.



 **Important!** Do not use any sharply pointed objects to clean the condenser. They could make it leak.

 Reinsert and push in and turn each one of the two securing disks through a quarter turn inwards. The words "top – oben – en haut" must be at the top.

 Re-mount the plinth.

 **Important!** The dryer must not be operated without condenser.

Something not working?

If the tumble dryer is not working correctly please carry out the following checks before calling out an engineer.

Symptom	Possible cause	Solution
The tumble dryer will not start	The appliance is not plugged in	Plug in the appliance
	The fuse has blown	Check the fuse
	The START button has not been pressed	Press the START button
	No program has been selected	Select the required program
	The door is not properly closed	Close the door
	The water reservoir is full	Empty the water reservoir
The result are unsatisfactory	The wrong program has been selected	Select a different program
	Fluff filter blocked	Clean the fluff filter
	Condenser unit covered with fluff	Clean the condenser unit
	The tumble dryer has been overloaded	Observe the maximum loads stated for each program
	Laundry not sufficiently spun prior to tumble drying	Ensure the wash load is well spun before tumble drying
	The vent in the base of the appliance is covered	Ensure the vent is clear
	A residue may have formed on the drum interior, blocking the sensors	Clean the inside of the drum with white vinegar

Something not working?

Symptom	Possible cause	Solution
The drum illumination does not work	Is the tumble dryer plugged in	Plug in the tumble dryer
	The program selector is in the OFF position	Turn the program selector dial to LIGHT
	The bulb needs replacing	Replace bulb
The drying process takes unusually long	The condenser unit is covered with fluff	Clean the condenser unit
	Fluff filter is clogged	Clean the fluff filter
The door cannot be closed	Fluff filter has not been inserted correctly and/or the filter lid not closed	Replace the fluff filter and ensure the filter lid is closed
Display EMPTY WATER is lit	Condensate container full	Empty the condensate container
EMPTY WATER indicator illuminated, even though the container has already been emptied	Foreign bodies, e. g. animal hairs, can block the inlet nozzle as well as the valve on the end of the EMPTY WATER container	With the container pulled out, switch on the appliance momentarily. The blockage can be removed from the container shaft or the hair cleaned out of the valve

If after these checks, the tumble dryer still does not work, contact your local AEG Service Force Centre.

Please note that it will be necessary to provide proof of purchase for any in-guarantee service calls.

In-guarantee customers should ensure that the above checks have been made as the engineer will make a charge if the fault is not a mechanical or electrical breakdown.

Replace the interior light

 A replacement bulb can be purchased through your local AEG Service Force Centre (Part No: 647072580).

 **Warning!** Never use standard light bulbs in your Lavatherm.

 Isolate the appliance from the mains supply.

 Screw-off the bulb cover. (The bulb is located at the top behind the door; see *Front view*).

 Replace the defective bulb.

 Screw-on the bulb cover.

 **Warning!** For safety reasons the bulb cover must be screwed-on. The dryer must not be operated, without the cover in place.

Door Reversal Instructions







The door opening direction can be changed if required.

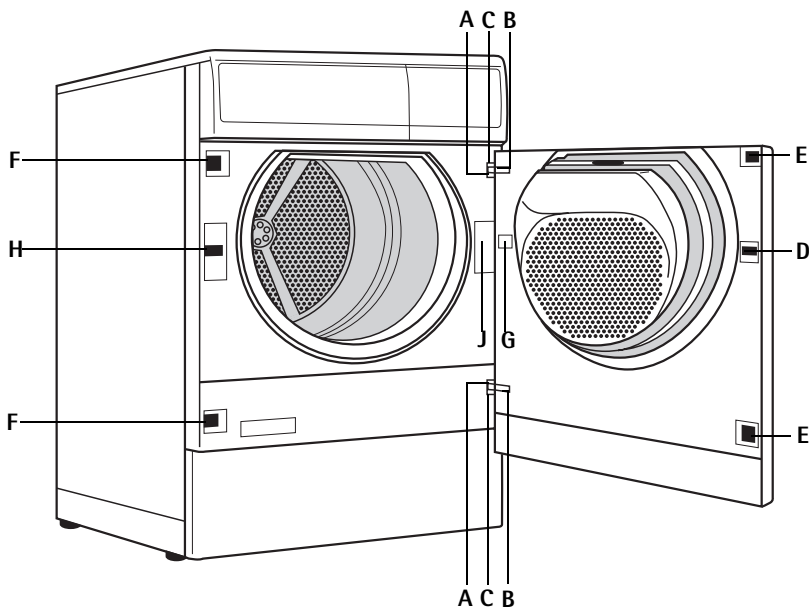





Warning! Before reversing the door, isolate the appliance from the mains supply.

Proceed as follows to reverse the door opening direction:



-  Un-screw the screws A on the front panel of the appliance.
-  Take-off the door by displacing it horizontally.
-  Un-screw the screws B on the inside of the door and take-off the hinges C.
-  Unscrew and take-off the locking block D.
-  Release the coverplates E, F and G with a thin screwdriver by pressing on the latching device, displace them to the side. Take them out and insert them again on the opposite side.
-  Screw-on the hinges C and the locking block D on the opposite side of the door.
-  Screw-off the door catch H, take it out and pull-off the plug.

-  Take-out the latched catch covering J and pull-off the plug.
-  Connect the door catch H and the catch covering J on the respective opposite side to the plug, insert into the break-out and screw-down or latch into position.
-  Push the door with the hinges into the breakouts provided for them in the front panel of the appliance and firmly attach it with the screws.
-  After changing-over the door, check that the DOOR button functions correctly.



Warning! The appliance is safe again for operation only when all plastic parts have been mounted.

Technical data

Height x Width x Depth	85x60x60cm
Depth with the door open	117cm
Height adjustable from	1.0/-0.4cm
Empty weight	approx. 46kg
Load (depending on the program)	max. 5kg
Power consumption in acc. with IEC 1121 s.e. (5 kg Cotton, spun at 800 revolutions per minute, program COTTON CUPBOARD DRY)	3.5kWh
Area of use	Household
Permissible ambient temperature	+5°C up to +35°C

- CE** This appliance complies with the following EC directives:
- 73/23/EEC of 19/2/1973 'Low voltage directive'
 - 89/336/EEC of 3/5/1989 'EMC directive' including the Modification directive 92/31/EEC

Electrical Connection

Any electrical work required to install this appliance should be carried out by a qualified electrician or competent person.



WARNING - THIS APPLIANCE MUST BE EARTHED.

The manufacturer declines any liability should these safety measures not be observed.

Before switching on, make sure the electricity supply voltage is the same as that indicated on the appliance rating plate. The rating plate is located inside the door.

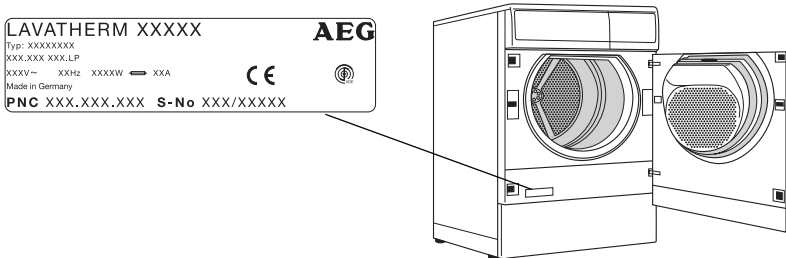



LAVATHERM XXXXX **AEG**
 Type: XXXXXXXX
 XXX.XXX.XXX.LP
 XXXV ~ XXHz XXXXW ← XXA
 Made in Germany
 PNC XXX.XXX.XXX S-No XXX/XXXXX

The appliance is supplied with a 13amp plug fitted. In the event of having to change the fuse in the plug supplied, a 13amp ASTA approved (BS 1362) fuse must be used.

Should the plug need to be replaced for any reason. The wires in the mains lead are coloured in accordance with the following code:

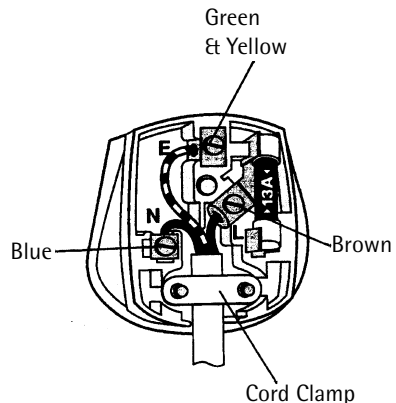
Green and Yellow	: Earth
Blue	: Neutral
Brown	: Live



- The wire coloured green and yellow must be connected to the terminal marked with the letter "E" or by the earth symbol  or coloured green and yellow
- The wire coloured blue must be connected to the terminal "N" or coloured black.
- The wire coloured brown must be connected to the terminal marked "L" or coloured red.
- Upon completion there must be no cut, or stray strands of wire present and the cord clamp must be secure over the outer sheath.



WARNING: A cut off plug inserted into a 13 amp socket is a serious safety (shock) hazard. Ensure that the cut off plug is disposed of safely.

Permanent connection

In the case of a permanent connection it is necessary that you install a double pole switch between the appliance and the electricity supply (mains), with a minimum gap of 3 mm between the switch contacts and of a type suitable for the required load in compliance with the current electrical regulations.

The switch must not break the yellow and green earth cable at any point.

Positioning

To ensure correct operation:

- The appliance must be level. Use a spirit level if necessary and adjust the feet to compensate for any unevenness in the floor.
- The surrounding area must be kept clean, free of dust and fluff.
- Do not install the appliance where the temperature may fall below freezing or rise above 35 °C.
- Do not install the appliance on deep pile carpets or obstruct the front ventilation grille, as this will affect the air circulation and could lead to a build-up of heat which would adversely affect the operation of the machine.

Special accessories

You can obtain the following special accessories from your retailer.

Drainage kit

A drainage kit (E-No. 916 019 000) can be purchased to adapt the dryer to drain the condensed water into an existing drain, sink etc. This eliminates having to empty the condensed water reservoir, although the reservoir must still be inserted into the control panel of the machine.

Stacking kit

With these kits you can combine your laundry dryer with any LAVAMAT automatic washing machine to a washing and drying column. The appliances are stacked in space-economising manner in this arrangement, the washing machine at the bottom and the laundry dryer at the top.

The following two kits are available:

- without plate E-No. 916 018 900
- with extendible deposit plate E-No. 916 018 901

Guarantee Conditions

AEG offer the following guarantee to the first purchaser of this appliance.

1. The guarantee is valid for 12 months commencing when the appliance is handed over to the first retail purchaser, which must be verified by purchase invoice or similar documentation. The guarantee does not cover commercial use.
2. The guarantee covers all parts or components which fail due to faulty workmanship or faulty materials. The guarantee does not cover appliances where defects or poor performance are due to misuse, accidental damage, neglect, faulty installation, unauthorised modification or attempted repair, commercial use or failure to observe requirements and recommendations set out in the instruction book.

This guarantee does not cover such parts as light bulbs, removable glassware or plastic, dust bags or filters.

3. Should guarantee repairs be necessary the purchaser must inform the nearest customer service office (manufacturer's service or authorised agent). AEG reserves the right to stipulate the place of the repair (i. e. the customer's home, place of installation or AEG workshop).
4. The guarantee or free replacement includes both labour and materials.
5. Repairs carried out under guarantee do not extend the guarantee period for the appliance. Parts removed during guarantee repairs become the property of AEG.
6. The purchaser's statutory rights are not affected by this guarantee.

European Guarantee

If you should move to another country within Europe then your guarantee moves with you to your new home subject to the following qualifications:

- The guarantee starts from the date you first purchased your product.
- The guarantee is for the same period and to the same extent for labour and parts as exist in the new country of use for this brand or range of products.
- This guarantee relates to you and cannot be transferred to another user.
- Your new home is within the European Community (EC) or European Free Trade Area.
- The product is installed and used in accordance with our instructions and is only used domestically, i. e. a normal household.
- The product is installed taking into account regulations in your new country.

Before you move please contact your nearest Customer Care Centre, listed below, to give them details of your new home. They will then ensure that the local Service Organisation is aware of your move and able to look after you and your appliances.

France	Senlis	+33 (0) 44 62 29 29
Germany	Nürnberg	+49 (0) 800 234 7378
Italy	Pordenone	+39 (0) 800 117511
Sweden	Stockholm	+46 (0) 8 672 5360
UK	Slough	+44 (0) 1753 219899

Service & Spare Parts

In the event of your appliance requiring service, or if you wish to purchase spare parts, please contact Service Force by telephoning:

08705 929 929

Your telephone call will be automatically routed to the Service Force Centre covering your post code area.

For the address of your local Service Force Centre and further information about Service Force, please visit the website at www.serviceforce.co.uk

Before calling out an engineer, please ensure you have read the details under the heading „What to do if....“

When you contact the Service Force Centre you will need to give the following details:

1. Your name, address and post code.
2. Your telephone number
3. Clear and concise details of the fault.
4. The model and serial number of the appliance (found on the rating plate)

PNC no.

S no.

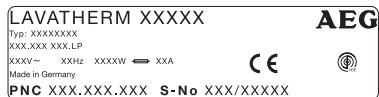

5. The purchase date

Please note that a valid purchase receipt or guarantee documentation is required for in-guarantee service calls.

Customer Care

For general enquiries concerning your AEG appliance or for further information on AEG products please contact our Customer Care Department by letter or telephone at the address below or visit our website at www.aeghome.co.uk.

Customer Care Department
AEG Domestic Appliances
55-77 High Street
Slough
Berkshire, SL1 1DZ

Tel. 08705 350350 (*)

(*) Calls may be recorded for training purposes

Index

A

- Acrylate 16
- Acrylic 22
- Anorak 15
- AUDIBLE SIGNAL 15
- AUDIBLE SIGNAL (button) 17

C

- Closing the fill-in door 19
- Condenser 19, 24
- Connection 31
- Control panel 12
- Cool-down phase 17
- Crease protection phase 17
- Customer care 36

D

- Door 28

E

- Easy-care fabrics 22

F

- Filter area 23
- Fluff filter 19
- Front view 11
- Furniture polish 23

G

- Glossary 22
- Guarantee 34, 35

I

- Installation 6
- Interior light 27
- Ironing 10

O

- Opening the door 15

P

- Packaging 8

R

- Rating plate 36

S

- Safety Information 5
- Service & Spare Parts 36
- SPECIAL CARE 15
- START 16

T

- Two-layer fabric 15

U

- Use condensate 10

V

- Viscose 22

W

- Water reservoir 18
- Wool 22

The Electrolux Group is the world's largest producer of powered appliances for kitchen, cleaning and outdoor use. More than 55 million Electrolux Group products (such as refrigerators, cookers, vacuum cleaners, chain saws and lawn mowers) are sold each year to a value of approx. 14 billion USD in more than 150 countries around the world.



From the Electrolux Group. The world's No.1 choice.

AEG Hausgeräte GmbH
Postfach 1036
D-90327 Nürnberg

<http://www.aeg.hausgeraete.de>

© Copyright by AEG

H 245 216 540 -00- 0202/PRO

Subject to change without notice

This file has been downloaded from:

www.UsersManualGuide.com

User Manual and User Guide for many equipments like mobile phones, photo cameras, mother board, monitors, software, tv, dvd, and othes..

Manual users, user manuals, user guide manual, owners manual, instruction manual, manual owner, manual owner's, manual guide, manual operation, operating manual, user's manual, operating instructions, manual operators, manual operator, manual product, documentation manual, user maintenance, brochure, user reference, pdf manual