

LAVATHERM 37700

Vented Tumble Dryer

Operating Instructions



Dear customer,

Please read these operating instructions through carefully, before using the appliance.

Please ensure you fully understand the safety instructions on the first pages of these operating instructions! Retain this instruction book for future reference, and pass on to any future owners.



The warning triangle and/or the key words (**Warning!**, **Caution!**, **Important!**), emphasize information which is important for your safety or the correct functioning of the appliance. It is essential that this information is observed.



This symbol guides you step by step when operating the appliance.



This symbol gives additional information and practical tips on using the appliance.



Tips and information about the economical and environmentally friendly use of the machine are marked with the clover symbol.

These operating instructions contain information about how to independently solve any problems which may arise. See "Troubleshooting".

Printed on environmentally friendly paper ...
Whoever thinks ecologically also acts ecologically.

Content

Important Safety Information	5
General Information	8
Disposal	9
Packaging	9
Environmental protection tips	10
The chief features of your appliance	12
Description of the appliance	13
Front view	13
The program selector positions	15
Before using the appliance for the first time	15
Brief operating instructions	16
Drying	17
Prepare the laundry	17
Open the door	17
Load the laundry	17
Select the drying program	17
Start time pre-selection	19
Start the drying program	19
Removing laundry or loading laundry when necessary	20
End of the drying process	20
Removing the laundry	20
Switch-off the dryer	20
Clean the fluff filter	21
Program tables	22
A small glossary of textile information	24
Care symbols	24
Cleaning and maintenance	25
Cleaning the filter area	25
Cleaning the drum	25
Cleaning the panel and operating parts	25
Something not working?	26
Replace the interior light	28

Door Reversal Instructions	29
Programming possibilities	31
Special accessories	32
Stacking kit	32
Technical data	33
Power supply	33
Information for the electrician	33
Index	34
Service	35



Important Safety Information

The safety of AEG electrical appliances complies with the established technical principles and statutory equipment safety regulations. Nevertheless, as manufacturer we have to draw your attention to the following safety instructions.

General safety

- Repairs of the dryer may be carried out only by trained personnel. Incompetently carried out repairs can entail considerable hazards for the user. Please get in touch with our customer service or with an authorised AEG dealer when repair is necessary.
- Before commencing operation please make sure that the nominal voltage and type of supply specified on the type plate of the appliance correspond to the actual nominal voltage and supply type at the place of utilisation. The fuse rating is also specified on the type plate.
- Never operate the dryer when the mains cable is damaged or when the operator control mask, work plate or base shrouding are damaged such that there is direct access to the interior of the appliance.
- Switch-off the dryer before carrying out any cleaning, care and maintenance tasks! You are quite safe if you disconnect the mains plug from the power outlet or – if the electrical connection is permanent – if you switch-off the circuit breaker in the fusebox or screw the fuse cartridge right out of its holder.
- Never pull on the cable to disconnect the mains plug from the power outlet. Always grasp and pull-out the plug.
- Don't lean on the opened door; this could make the appliance fall over.
- Don't use a water jet to spray-down the appliance. Danger of electric shock!
- The covering hood for the filament lamp bulb for drum illumination must be screwed-on.
- If you interrupt the drying process to take out laundry, bear in mind that the laundry and the drum could be hot.
- Adaptors and extension cables must not be used. There is risk of overheating!

Safety of children

- Children are often not aware of the dangers involved when handling electrical equipment. Therefore provide the necessary supervision of children when operating the appliance and do not let children play with the dryer – there is a danger that children could become trapped inside the appliance.
- Packaging parts (e.g. films, styropore) can be dangerous for children. Danger of suffocation! Keep packaging parts out of reach of children.
- Make sure that children or small animals do not climb into the drum of the dryer. For this purpose keep the door of the dryer closed when the appliance is not in use.

Utilisation in accordance with the intended purpose

- Conversions or modifications of the dryer are forbidden for safety reasons.
- Use the dryer only to dry ordinary household laundry! The manufacturer accepts no liability for any damage resulting from incorrect operation or utilisation for an unintended purpose.
- Dry only laundry which has been washed in water. In particular, textiles which have been treated with inflammable cleaning agents and solvents (petrol-ether, alcohol, stain remover and similar materials) must not be dried in the dryer. Danger of fire! Explosion hazard!
- Laundry items containing sponge rubber or rubber-like materials must not be dried in the dryer. Danger of fire!
- Washing that is in poor condition (heavily worn) and items with loose fillings (cushions) that could break open must not be dried. There is a risk of fire!
- Washing with rigid components (foot mats) will cover the air slots; the slots will also be covered if the drum is overfilled. Observe the maximum load of 5 kg. There is a risk of overheating which could cause a fire!
- Only dry washing that does not contain any explosive objects (fire lighters, spray cans). There is a risk of fire or an explosion!

Erection and connection

- Please follow the separate *Installation and connection instructions*. If necessary get some advice from your local chimney sweep or building authorities.
- If the tumble drier has to be carried, first remove the base strip!
- Check the tumble drier for transport damages. Under no circumstances should you connect a damaged appliance! Please contact your supplier in the event of damages.
- Do not install the tumble drier in rooms which are in danger of freezing!
- Install the tumble drier level!
- When installed next to a gas, coal or electric heater: a heat insulating, non-flammable board must be inserted (dimensions: 85x57.5 cm).
- The plug of the appliance must be freely accessible after installation.
- The outgoing air from the tumble drier may not be led into a smoke or chimney flute.
- Do not lead the outgoing air into a shaft which serves to ventilate rooms in which heating is installed.
- Do not install the tumble drier in a room in which heaters with coal and oil connected to a chimney are located in which the under pressure is 0.04 mbar or more.
- Provide sufficient ventilation to avoid underpressure from forming.
- In accordance with the technical connection conditions of the power utilities, a permanent connection to the power supply may only be made by an authorised electrician.
- The dryer sucks in air. You should therefore keep the area around the appliance clean and also not store any flammable items that may be sucked into the appliance (e.g. cat litter, shavings) in front of it. There is risk of fire!

i General Information

- Starched washing leaves traces of starch on the drum and therefore should not be placed in the tumble drier.
- If you exceed the maximum load stipulated in the program table your washing is more likely to get creased! For very delicate fabrics you should only fill in 1.5kg washing at the most.
- When using so-called "fabric conditioner sheets", a deposit on the fluff filter may result, which can cause a blockage. We therefore recommend not using fabric conditioner sheets.
- For your information: 70 per cent of fabric wear is caused by being worn, 20 per cent by washing and only 10 per cent by being dried in a tumble drier. As the fabric is worn down, fluff gathers in the fluff filter. When using a tumble drier, only approx. 0.03g fluff per kilogramme washing is produced.

 **Disposal****Packaging****Dispose of the packaging material!**

Dispose of the packaging material of your tumble drier correctly. All packaging materials are environmentally friendly and can be disposed of without any danger or burnt in the refuse incinerator.

The plastic parts can be reused:

- The external plastic cover and the bags inside are made of polyethylene (marking >PE<).
- The padding is made of CFC free expanded polystyrene (marking >PS<).

The boxes are made from recycled paper and should be returned to the old paper collection.

Disposal of the old appliance!

When you eventually stop using your tumble drier please bring it to the nearest recycling centre or to your dealer who will take it back for a small fee.



Warning! When disposing of the tumble drier, pull out the plug, cut off the flex, dispose of the plug and remaining flex and destroy the door lock. This hinders children from locking themselves in and endangering their lives.

The materials can be recycled in accordance with their markings. Standard tools (crosshead screwdriver, hammer) are sufficient to dismantle the old appliance.



Environmental protection tips

- Your laundry will become light and soft in the tumble dryer even without a fabric softening agent.
- Loosen your laundry before loading it into the dryer. This helps to prevent lengthy running times and creasing. Ensure your laundry is well spun.

In the following table we give an overview of specific electric consumption data depending on the spinning speed. This information is valid for 5kg laundry dried with the program COTTONS CUPBOARD DRY:

Spinning/wringing out:			Drying cycle:	
Revolutions per minute	Residual dampness		Time required in minutes	Energy requirement in kWh
	in litres	in %		
800	3.5	70	115	3.2
1000	3.0	59	100	2.7
1200	2.7	53	90	2.4
1400	2.5	50	90	2.3
1600	2.4	47	80	2.2

- Observe the maximum load instructions. Whenever possible, dry full loads.

- Select the appropriate drying program for the type and quantity of laundry. The dryer will then operate as economically as possible. Some typical consumption values:

Drying program	Fill weight in kg	Duration in Minutes	Power consumption in kWh
COTTONS CUPBOARD DRY ¹	5	115	3.2
COTTONS HAND IRON ¹	5	90	2.5
EASY CARES CUPBOARD DRY ²	2.5	50	1.2

1) spun at 800 revolutions per minute

2) spun at 1000 revolutions per minute

If the amount of laundry is not enough for a particular degree of drying (e.g. HAND IRON), you should dry it in stages for best economy: Fill the drier and select the program HAND IRON; after the end of this program take out your laundry for ironing. Finally dry the remaining laundry with the program CUPBOARD DRY.

- Only use the SPECIAL CARE button for loads up to 2.5kg.
- Clean the fluff filter after every drying program!

The chief features of your appliance

- Program or time setting via the program selector
- **Audible Signal** can be selected in addition; an intermittent audible signal is sounded after the end of the program.
- **SPECIAL CARE button** for gentle drying of sensitive fabrics
- **QUICK button** for quick drying
- **DELAY TIMER:** Program start delayed by 1 to 19 hours (e.g. for operation at times when electricity is cheaper)
- **Multi-display** for displaying
 - probable program duration and time remaining until program end,
 - Time preselection (start time postponement or time remaining until program start,
 - Error code.
- **Indication of degree of drying**
- **Program run display**
- **Programming facility** for permanent adaptation of the program sequence to your requirements.

Description of the appliance

Front view

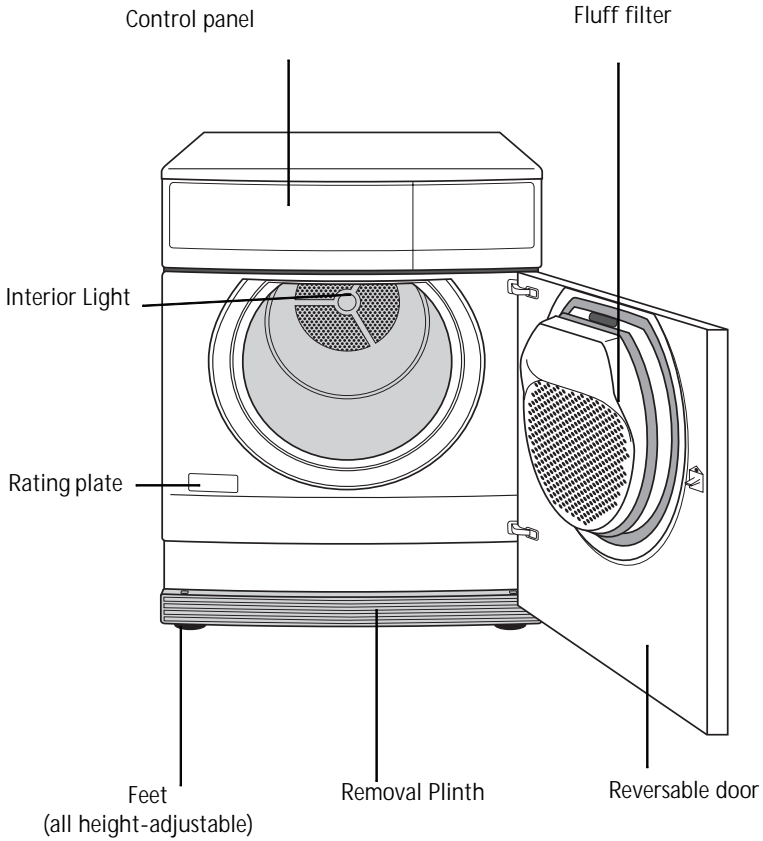

Control panel

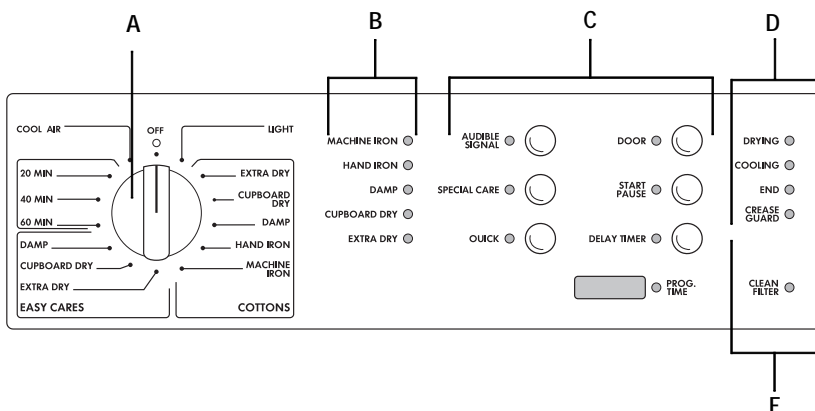

- A Program selector: for setting the drying program
- B Drying degree indicator: Shows the achieved extent of drying; this enables you to take-out individual pieces of laundry at the right time during the drying process.
- C Buttons and display block
- AUDIBLE SIGNAL button: When switched-on, an audible signal is sounded at the end of the drying program; then take-out the laundry
 - SPECIAL CARE button: For sensitive fabrics
 - QUICK button: Shortens the drying time.
 - DOOR button: For opening the fill-in door when the appliance is switched-on.
 - START/PAUSE button: To start or interrupt the program.
 - DELAY TIMER button: For pre-setting the start time in the range from 1 to 19 hours; indication in the PROG. TIME display field
 - Multi-display/Display PROG.PROG. TIME TIME: Indicates the probable program duration or the time remaining of the currently set drying program; with postponed start time (DELAY TIMER button) indication of the number of hours left until the drying program starts; an error code is displayed in the case of a disturbance (E and a number).
- D Program run display: The currently running phase of the drying process is indicated.
- E Instructions for the user:
- FILTER display: Clean the fluff filter!

The program selector positions

- **OFF:**
The tumble dryer is switched off.
- **LIGHT:**
The drum light switches on when the door is opened.
- **Program group COTTON:**
Programs for drying cotton and linen fabrics;
maximum load 5 kg.
- **Program group EASY CARES:**
Programs for drying mixed fabrics and synthetics;
maximum load 2.5 kg.
- **Time programs:**
For additional drying or for drying loads of less than 1 kg.
- **COOL AIR Program:**
For smoothing creases in cold air;
Slightly moisten the creased articles;
Program duration: 10 minutes.

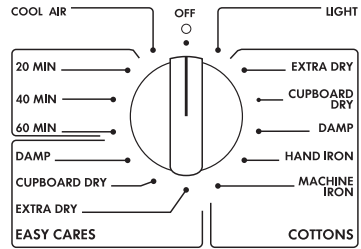

Before using the appliance for the first time

-  Wipe the drum of the dryer with a moist cloth.

Brief operating instructions

- Ensure the laundry is well spun before tumble drying.
- Prepare the laundry.
- Load the laundry.
- Select the drying program
 - on the program selector.
 - If required press the buttons AUDIBLE SIGNAL, SPECIAL CARE, QUICK.
- Pre-select the start time
- Start the program.

While the program is running you can open the door to take-out laundry or add more laundry.

At the end of the program:

- Remove the laundry.
- Clean the fluff filter.
- Switch-off the dryer.

Drying

Prepare the laundry

- To prevent tangled bundles of laundry: Close zip fasteners; button-up bed linen and pillow cases; tie-together loose tapes, e.g. aprons.
- Empty all pockets.
- Remove all metal objects (paper clips, pins, etc.).
- Turn clothing consisting of double-layer fabric inside out (such as cotton-lined anoraks with the cotton layer facing outwards). The fabrics will dry better.
- Loosen the laundry.

Open the door

To open the door:

- Press firmly against the door (Press position )

or

- while the drier is switched-on: Press the DOOR button.

Load the laundry

- Load the prepared laundry into the dryer.



Caution! Ensure the laundry does not get caught in the door when the door is closed! This could damage the laundry!

Select the drying program



Select the suitable drying program using the program selector (see "Program tables").

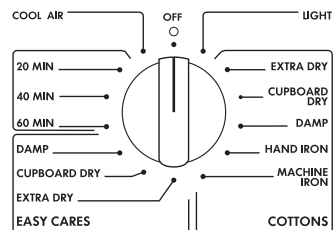



If required, select the button AUDIBLE SIGNAL, SPECIAL CARE, QUICK.

AUDIBLE SIGNAL 

SPECIAL CARE 

QUICK 

- AUDIBLE SIGNAL button
During the crease-protection phase (immediately after the drying process), an acoustic signal is sounded at certain intervals (see "End of drying process").
- SPECIAL CARE button
This program operates with reduced heat. Press the SPECIAL CARE button for fabrics bearing the care symbol . Gentle drying is advisable for heat-sensitive fabrics (such as acrylic and viscose).
- QUICK button
The selected program runs with shortened program duration for the same degree of drying.

Start time pre-selection

With the start time pre-selection you can program the start delay of the drying program in the range from 1 to 19 hours.

 Setting the program.

 Hold the DELAY TIMER button depressed until the desired number of hours of delay of the program start appears in the display field for PROG. TIME.

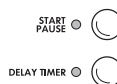

 Press the START/PAUSE button.

After elapse of the set number of hours the drier automatically starts the set drying program. The PROG. TIME display field shows the number of hours after which the drying program will start.

You can correct the pre-selected start delay time at any time.

Start the drying program

 Press the button START/PAUSE.

The drying program starts.

You can see the progress of the drying process by looking at the drying degree and program run displays.





Removing laundry or loading laundry when necessary

You can interrupt the drying process at any time to remove some of the laundry or to add more laundry.

 You can see by looking at the display field PROG. TIME, how long the drying program will probably still take. This display becomes increasingly accurate, the longer the drying process has already been running.

 Open the door.

 **Caution!** The laundry and the drum may be hot.

 Remove or add more laundry.

 Close the door.

 Press the START/PAUSE button to resume the drying process.

End of the drying process

The **cooling phase** starts shortly before the end of the drying process: The heater is switched-off during this phase.

After the cooling phase you can remove the laundry from the dryer.

The **crease guard phase** follows automatically after the drying process. The drum rotates intermittently. This keeps your laundry loose and crease-free.

If you have pressed the AUDIBLE SIGNAL button, an acoustic signal is sounded intermittently during this phase.

Removing the laundry

 Open the door and remove the laundry.

Switch-off the dryer

 Turn the program selector to the OFF position.

Clean the fluff filter

To ensure efficient operation of the tumble dryer, clean the fluff filter after each drying program.

Also check whether there are any remnants or fluff from the washing in the drum; remove immediately.

-  Press the catch of the filter lid downwards.

The filter lid will open.

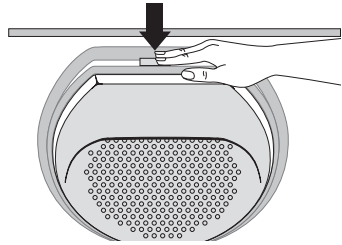



-  Take-out the fluff filter.

-  Remove fluff out of the fluff filter, with a moistened hand.

-  Re-insert the fluff filter.

-  Press against the filter lid until it catches into the locking device.

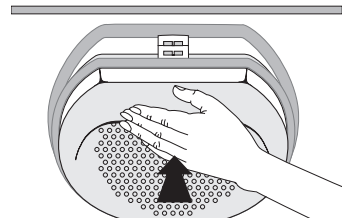
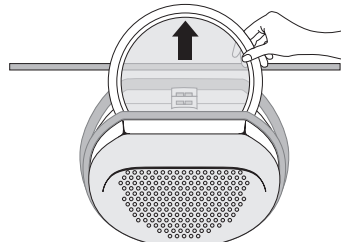

-  The filter lid cannot catch shut without the fluff filter in place and the door cannot be closed.

-  **Warning!** The dryer must not be operated with a damaged or blocked fluff filter!



Program tables

Program group COTTONS

care symbols , ; maximum load 5 kg

Program	Laundry Type	Examples for
EXTRA DRY	Heavy weight or mult-layered fabrics	Towelling material, bath robes
CUPBOARD DRY	Fabrics of medium weight, articles not made up of mult-layers	Towel laundry, hand towels
DAMP	Lightweight materials requiring ironing	Cotton shirt and underwear
HAND IRON	Normal cotton and linen articles	Sheets and pillowcases, tablecloths
MACHINE IRON	Cotton and linen articles, to be ironed by rotary ironer or starched laundry	Cotton sheets and pillowcases, tablecloths

Program group EASY CARES

care symbols , ¹, ; maximum load 2.5 kg

Program	Laundry Type	Examples for
EXTRA DRY	Heavy weight or mult-layered fabrics	Sweatshirts, bed linen and table linen
CUPBOARD DRY	Lightweight materials which do not require ironing	Easycare fabric shirts, table linen, baby clothes, socks and underwear
DAMP	Lightweight synthetics and cotton/polyester mixtures requiring ironing	Bed and table linen, easycare fabric shirts and blouses

1) Press the SPECIAL CARE button!

TIME programs

care symbols , ¹, ; loads less than 1 kg

You can select 20, 40 and 60 minutes program duration for additional drying of individual pieces of laundry or to dry small quantities.

1) Press the SPECIAL CARE button!

COOL AIR Program

The laundry is treated for 10 minutes in cold air; for smoothing creased clothing.

A small glossary of textile information

Care symbols

Ensure articles to be dried are suitable for tumble drying. If they are one of the following symbols should be present on the care label:

 This fabric can be tumble dried. The fabric manufacturer does not stipulate if the piece of laundry should be dried on a normal or gentle program.

 Normal drying

 Drying with special care (press the SPECIAL CARE button!)

 Do not tumble dry

If you do not find any of these care symbols:







Dry whites and coloureds as well as mixed fabrics at normal temperature. Press the SPECIAL CARE button if you are drying delicate fabrics.

- Wool
Do not dry any woollen items in the dryer.
- Fabrics sensitive to temperatures
Dry fabrics sensitive to temperatures (such as acrylic or viscose) and textiles with the care label  with the SPECIAL CARE button selected.
- Cotton jersey and hosiery have a tendency to shrink! Do not dry these fabrics excessively.
- New coloured textiles
To avoid the possibility of dye transference do not dry new coloured textiles together with light-coloured laundry.

Cleaning and maintenance

Cleaning the filter area

 **Important!** A small amount of fluff may reach the area around the filter in spite of the fluff filter. Therefore you should clean the entire filter area from time to time, or at least every three months.

-  Remove the fluff filter.
-  Hold the filter lid by the top and pull it forwards until it is released from both holders.
-  Remove the fluff from the entire filter area – preferably with a vacuum cleaner.
-  Press both pins of the filter lid into the holders on the door until they click in.
-  Reinsert the fluff filter.
-  Press against the filter lid until it clicks into the lock.

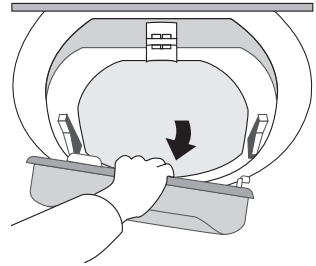



Cleaning the drum

 **Warning!** Do not clean the stainless steel drum with abrasive detergents or steel wool!

-  Wipe the inside of the drum and the drum fins with white vinegar to avoid a build up of residues/deposits effecting the sensors. This is particularly important if you regularly use fabric conditioning sheets or dry starched items in the dryer.

Cleaning the panel and operating parts

 **Warning!** Do not use household furniture polish or aggressive detergents.

-  Wipe over the panel and operating parts with a damp cloth. Only use warm water.

Something not working?

If the tumble dryer is not working correctly please carry out the following checks before calling an engineer.

Symptom	Possible cause	Solution
The tumble dryer will not start	The appliance is not plugged in	Plug in the appliance
	The fuse has blown	Check the fuse
	The START/PAUSE button has not been pressed	Press the START/PAUSE button
	No program has been selected	Select the required program
	The door is not properly closed	Close the door
The results are unsatisfactory	The wrong program has been selected	Select a different program
	Fluff filter blocked	Clean the fluff filter
	The tumble dryer has been overloaded	Observe the maximum loads stated for each program
	Laundry not sufficiently spun prior to tumble drying	Ensure the wash load is well spun before tumble drying
	A residue may have formed on the drum interior, blocking the sensors	Clean the inside of the drum with white vinegar
The drum illumination does not work	Is the tumble dryer plugged in	Plug in the tumble dryer
	The program selector is in the OFF position	Turn the program selector dial to LIGHT
	The bulb needs replacing	Replace bulb

Symptom	Possible cause	Solution
The drying process takes unusually long	Spent air removal disturbed	Make sure that there are no kinks in the spent air hose and/or clean the spent air removal ducts
	Fluff filter is clogged	Clean the fluff filter
The door cannot be closed	Fluff filter has not been inserted correctly and/or the filter lid not closed	Replace the fluff filter and ensure the filter lid is closed
The door cannot be opened with the DOOR button	Electric mains plug not connected	Connect the mains plug
	Program selector set to OFF	Set a program. The fill-in door can be opened at any time by pressing firmly against the door (pressing location )
The dryer terminates the drying process automatically: END is displayed shortly after program start; no display of the extent of drying	Too dry or too little laundry filled-in for the selected program	Select time program or higher drying stage (e.g. EXTRA DRY instead of CUPBOARD DRY)
The drying process takes unusually long. 4.5 hours after the beginning of the drying process: - END display flashes - acoustic signal sounds - discontinuation of the drying process - error code E5 is displayed	SPECIAL CARE button pressed and too much laundry filled-in	Check the program selection: SPECIAL CARE button appropriate only for laundry amounts up to 2.5kg
	Too much laundry filled-in	Reduce the amount of laundry filled-in
	Laundry too damp	Pre-dry the laundry more thoroughly

If you do not find the required information in this manual to remedy a disturbance, please call the customer service.

Replace the interior light

 A replacement bulb can be purchased through your local AEG Service Force Centre (Part No: 647072580).

 **Warning!** Never use standard light bulbs in your Lavatherm.

 Isolate the appliance from the mains supply.

 Screw-off the bulb cover. (The bulb is located at the top behind the door; see *Front view*).

 Replace the defective bulb.

 Screw-on the bulb cover.

 **Warning!** For safety reasons the bulb cover must be screwed-on. The dryer must not be operated, without the cover in place.

Door Reversal Instructions







The door opening direction can be changed if required.

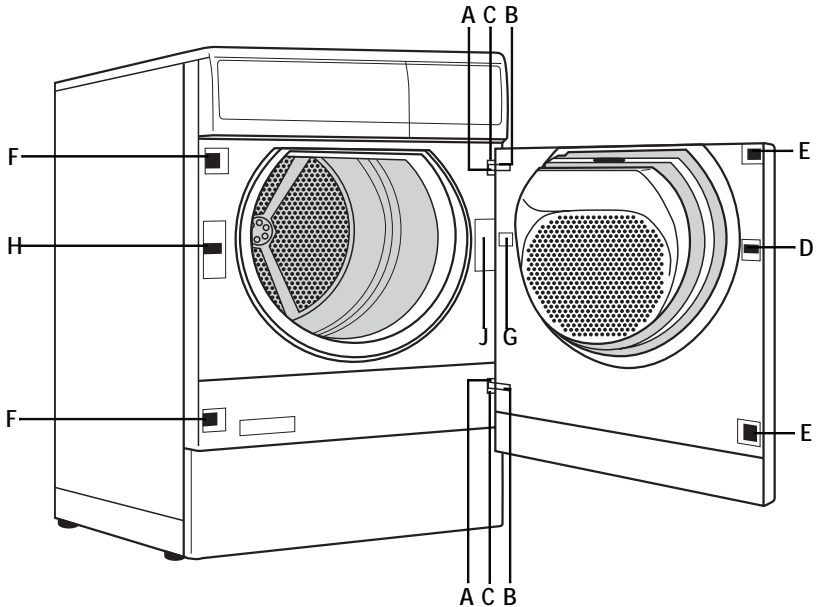





Warning! Before reversing the door, isolate the appliance from the mains supply.

Proceed as follows to reverse the door opening direction:



-  Un-screw the screws A on the front panel of the appliance.
-  Take-off the door by displacing it horizontally.
-  Un-screw the screws B on the inside of the door and take-off the hinges C.
-  Unscrew and take-off the locking block D.
-  Release the coverplates E, F and G with a thin screwdriver by pressing on the latching device, displace them to the side. Take them out and insert them again on the opposite side.
-  Screw-on the hinges C and the locking block D on the opposite side of the door.
-  Screw-off the door catch H and remove it and pull-off the plug.

-  Take-out the latched catch covering J and pull-off the plug.
-  Connect the door catch H and the catch covering J on the respective opposite side to the plug, insert into the break-out and screw-down or latch into position.
-  Push the door with the hinges into the breakouts provided for them in the front panel of the appliance and firmly attach it with the screws.
-  After changing-over the door, check that the DOOR button functions correctly.



Warning! The appliance is safe again for operation only when all plastic parts have been mounted.

Programming possibilities

The electronic control system of your laundry dryer provides you with the possibility to adapt some functions of the dryer permanently to your requirements.

Purpose	Execution
<p>"Laundry protection": If you want to "lock" the selected drying program (the selected program setting cannot be changed during the drying process at the program selector or with the SPECIAL CARE or QUICK button): When "Washing Protection" is enabled, the drying programme always runs at reduced heater power (SPECIAL CARE Function).</p>	<p>When a drying program is set at the program selector and the START button has been pressed:</p> <ul style="list-style-type: none"> • Hold the SPECIAL CARE button depressed for five seconds. <p>The program execution display flashes for five seconds and the laundry protection is then switched-on.</p> <p>If an attempt is nevertheless made to change the program setting, the program execution display flashes; after pressing the SPECIAL CARE or QUICK button, it flashes for five seconds; on turning the program selector it flashes until the program selector is returned to the initial setting.</p> <p>To cancel the laundry protection:</p> <ul style="list-style-type: none"> • Hold the SPECIAL CARE button depressed for five seconds. <p>The program run indicator flashes for five seconds, then it is lit steady for five seconds; laundry protection is cancelled.</p>
<p>If you always want to be reminded by an audible signal at the end of the program:</p>	<ol style="list-style-type: none"> 1) Ensure that the program selector is not in the setting LIGHT or OFF. 2) Hold the AUDIBLE SIGNAL button depressed for at least five seconds. <p>The AUDIBLE SIGNAL display lights; a short audible signal is sounded.</p> <p>The selected setting is therewith fixed-programmed.</p> <p>If you want to cancel this setting:</p> <ol style="list-style-type: none"> 3) Proceed as described under item 1) and 2). <p>The display AUDIBLE SIGNAL disappears.</p>

Purpose	Execution
<p>If the water quality in your household deviates strongly from normal and you wish to adapt the drying extent recognition of the dryer to your water quality:</p>	<p>1) Bring the program selector to the setting LIGHT. 2) Hold the DELAY TIMER button depressed for five seconds. The current setting appears in the RUNTIME display: H 1 is the standard setting (optimised for water with degree of hardness 2 and 3), with H 2 (for water with degree of hardness 4) the laundry becomes damper, with H 0 (for water with degree of hardness 1) the laundry becomes drier¹. 3) Press the DELAY TIMER button as many times as necessary to bring the desired value into the display. To take-over the selected setting permanently: 4) Turn the program selector. The selected setting is therewith fixed-programmed.</p>

1) The local water works can provide information regarding the water hardness and the hardness range in your domestic area.

Special accessories

You can obtain the following special accessories from your retailer.

Stacking kit

With these kits you can combine your laundry dryer with any LAVAMAT automatic washing machine to a washing and drying column. The appliances are stacked in space-economising manner in this arrangement, the washing machine at the bottom and the laundry dryer at the top.

The following two kits are available:

- without plate E-No. 916 018 900
- with extendible deposit plate E-No. 916 018 901

Technical data

Height x Width x Depth	85x60x60cm
Depth with the door open	117cm
Height adjustable from	1.0/-0.4cm
Empty weight	approx. 40 kg
Load (depending on the program)	max. 5kg
	(Different loads in some countries are due to different measuring methods)
Power consumption in acc. with IEC 1121 s.e.	3.2 kWh
	(5 kg Cotton, spun at 800 revolutions per minute, program COTTON CUPBOARD DRY)
Area of use	Household
Permissible ambient temperature	+5°C up to +35°C

- CE** This appliance complies with the following EC directives:
- 73/23/EEC of 19/2/1973 'Low voltage directive'
 - 89/336/EEC of 3/5/1989 'EMC directive' including the Modification directive 92/31/EEC

Power supply

Please refer to the type plate for specifications about the power supply. The nominal voltage stated on the type plate and type of current must be identical with the nominal voltage and type of current at the point of installation. Also refer to the type plate for the fuse required.

Information for the electrician

When connecting the appliance without a plug, care must be taken that this is done correctly. Please follow the relevant information in the section on installing and connecting the appliance.

For appliances with variable voltage settings, the switch-over diagram can be found on the cover of the connection box at the back of the appliance.

Index

A

Acrylate	18
Acrylic	24
Anorak	17
AUDIBLE SIGNAL	20

C

Children, safety	6
Closing the door	21
Connection	7
Control panel	14
Cool-down phase	20
COTTON	15
Crease protection phase	20
Creasing	8

D

Delicate fabric	8
Disposal	9
Door Reversal	29

E

Easy-care fabrics	24
Environmental protection	10
Erection	7

F

Fabric conditioner sheets	8
Fabric wear when drying	8
Fluff filter	21
Fluff quantity	8
Full load, specified	8
Furniture polish	25

G

Glossary	24
----------------	----

I

Interior light	28
Ironing	11

O

Opening the door	17
------------------------	----

P

Packaging	9
-----------------	---

R

Repair	5
--------------	---

S

Safety Information	5
Solvent(s)	6
SPECIAL CARE	11
Sponge rubber	6
Stacking kit	32
Starched washing	8
START	19

T

Transport damages	7
Two-layer fabric	17

V

Viscose	24
---------------	----

W

Wool	24
------------	----

Service

In the chapter "Troubleshooting" some disturbances have been summarised, which you can solve yourself. If you do not find any helpful information there, please contact your local customer service centre. It is nearby and if necessary can reach you quickly. (Addresses and phone numbers can be found in the Warranty Conditions/Service Departments)

Be well prepared before you phone. This facilitates the diagnosis and the decision as to whether a customer service visit is necessary. With our checklist you can gather important information before making your call:

Make a note of the PNC number and the S number. They are both on the type plate behind your tumble drier's door.

PNC

S-No

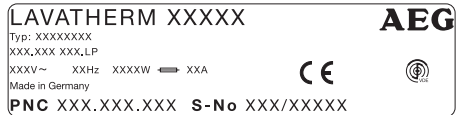

If possible establish:

- How is the disturbance evident?
- Under what circumstances does the disturbance occur?
- Does the multi-display issue an error message? (E and a number)?

When do you incur costs even during the warranty period?

- if you could have solved the disturbance yourself with the help of the Troubleshooting table (see section "Troubleshooting"),
- if the customer service engineer has to make several journeys because he did not receive all the necessary important information before his visit and now e.g. has to fetch spares. You can avoid these extra trips by preparing your telephone call properly in the way described above.

AEG Hausgeräte GmbH
Postfach 1036
D-90327 Nürnberg

<http://www.aeg.hausgeraete.de>

© Copyright by AEG

H 822 944 004 -00- 0698/PRO

This file has been downloaded from:

www.UsersManualGuide.com

User Manual and User Guide for many equipments like mobile phones, photo cameras, mother board, monitors, software, tv, dvd, and othes..

Manual users, user manuals, user guide manual, owners manual, instruction manual, manual owner, manual owner's, manual guide, manual operation, operating manual, user's manual, operating instructions, manual operators, manual operator, manual product, documentation manual, user maintenance, brochure, user reference, pdf manual