

*Model EOG 900*

## Introduction

This gas oven has been designed and manufactured to all the necessary British Standards. It also carries the C.E. mark. The oven complies with European Council Directive 90/396/EEC.

It is important that you understand how to use and care for the oven properly before you use it for the first time.

We have written this booklet with your safety in mind. Read the booklet thoroughly before you use the oven. Keep the booklet in a safe place so that anyone who uses the oven can read it. Pass the booklet on with the oven if you sell it to someone else.

### For your safety

The oven is designed to cook food and you must not use it for any other purpose.

Keep children, babies and toddlers away from the oven at all times.

The installation instructions that came with the oven tell you how and where it can be fitted. If the oven is already installed you must make sure that all instructions have been followed. If you are in any doubt ask a competent person. More details on installation on page 4.

We have included several drawings to show the right and wrong way of doing things.

The right way will have a smiling face by it.



A sad face shows something is wrong.



Do not remove the rating plate from the cookers as this may invalidate the guarantee.

<b>Contents</b>	<b>Page</b>
Installing the oven	4
General information	5
The cooling fan for the controls	5
Ignition	6
Oven lights	6
Lighting the oven and grill	7
The grill	9
The grill pan and handle	12
The oven	14
Baking trays and dishes	16
Oven cooking charts	17
Slow cooking	20
The electronic timer	23
Hints and tips for automatic cooking	26
Care and cleaning	27
What is wrong and why?	30
Replacing an oven light bulb	32
Servicing	33
Installation Instructions	35
Technical Data	36
Safety requirements/ventilation	37
Location of appliance	38
Installation	39
Testing	41
Guarantee conditions	45

## Installing the oven

### **For your safety**

This oven must be installed and serviced by a competent person as stated in the Gas Safety (Installation & Use) regulations current edition.

It is important that the oven is suitable for your gas supply. Your installer should check the data badge.

## Cabinet Dimensions

This oven must be fitted into a cabinet with a suitable sized aperture.

Minimum aperture height 874mm

Minimum aperture width 560mm

Minimum aperture depth 560mm

## Location

### **For your safety**

The use of a gas cooking appliance results in the production of heat and moisture in the room in which it is installed. Ensure that the kitchen is well ventilated: keep natural ventilation holes open or install a mechanical ventilation device (mechanical extractor hood).

Prolonged intensive use of the appliance may call for additional ventilation, for example opening of a window, or more effective ventilation, for example increasing the level of mechanical ventilation where present.

For further details see page 37.

## General information

To get the best results from your new oven please read these instructions carefully.

You should pay particular attention to cooking times and gas mark settings as these may differ from your previous oven. You may find it necessary to adjust these until you are more familiar with the oven.

### For your safety

**Do not** block any of the oven vents.

Never line any part of the oven with aluminium foil.

**Do not** let items which can catch fire or electric mains leads such as kettle flexes trail over any part of the oven.

Oven housing units vary widely in construction and finish. To avoid possible damage to the housing unit, you must not leave cabinet doors or flaps above the oven open or partially open when you use the grill or oven. If you have a storage area above your oven it will become warm when you use the oven. **Do not** store perishable foods in the storage area above the oven.

## The cooling fan for the controls

Your oven has a cooling fan. The cooling fan will start to work as soon as you light the grill or oven. You will be able to hear the fan when it is working.

The cooling fan may continue to work after you have turned off the oven or grill. It will switch itself on and off until the oven has cooled down.

If you want to turn off the electrical supply to the oven, you should not do so until the cooling fan has stopped working.

### For your safety

When you are using the grill or oven warm air will exhaust from the grill cavity and the vents below the control panel.

Take care not to stand too close to the oven or grill while in use.

## Ignition

The grill and oven burners light automatically when you turn on the control. If, for any reason either of the burners go out, the spark ignition will automatically relight it.

Please note:

You can only use the grill with the door fully or partially open. You cannot use the grill when the door is closed.

You cannot use the oven or grill in the event of a power failure.

## Oven light

Your oven is fitted with a oven light.

The oven light will come on when you use the oven.

Your Oven light bulb will usually last for many months. If the oven light will not work, you probably need to replace the bulb. See page 32 for details on how to change an oven light bulb.

### **For your safety**

This appliance must be earthed and protected by a 3 amp fuse.

The plug supplied with the oven can be fitted directly to a suitable three pin earthed socket.

If you have to change the fuse replace it with a 3 amp fuse which has been ASTA approved to BS 1362.

**Do not** use the plug until you have put the fuse cover back on. If the fuse cover is lost you can get a replacement from an electrical retailer. The correct replacement can be identified by marking or colour coding.

If you cut the plug off dispose of it safely as it will be a shock hazard if it is inserted into a 13 amp socket elsewhere in the house.

If the ignition system doesn't work there may be a fault with the electrical supply. First, check the socket by trying out another piece of electrical equipment in it, if that works correctly renew the fuse in the plug.

If the fuse keeps failing there is a fault in the oven which must be put right. **Do not** use a fuse with a rating higher than 3 amps. **Do not** carry out other electrical work. Unplug the oven and tell your installer.

## Lighting the oven and grill

### Grill

To light:

- 1 Open the grill door.
- 2 Push in the control knob and turn it to the highest setting. This is shown by a large flame symbol.

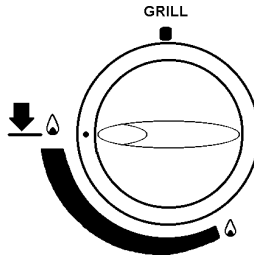

### For your safety

Never cover the grill pan or grid with foil as this can lead to grill fires.

### Oven

To light:

- 1 Open the oven door.
- 2 Push in the control knob and turn it to gas mark 9. When the burner has lit there will only be small flames at first.

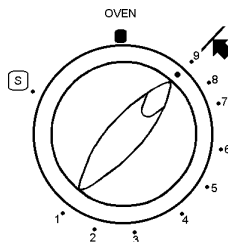

- 3 Now turn the control knob to the gas mark you want.
- 4 Wait until the burner is showing large flames.
- 5 Close the oven door.

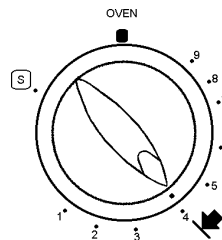

## To turn off any burner

- 1 Push in the control knob and turn it to the off position.  
This is shown by a large dot.

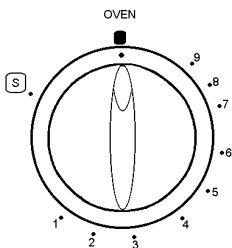

### For your safety

When you are lighting any burner check that it has lit before you leave the oven.

When you are turning off a burner **do not** leave the oven until the flame has gone out.



## The grill

We suggest that you run the grill without food for approximately 5 - 10 minutes to burn off any residue from the surface. During this period an odour may be emitted, it is therefore advisable to open a window for ventilation.

## Heat control

The grill gives variable heat settings.

The control knob turns to the left from 'OFF' to 'HIGH' and then to 'LOW'. The high setting should be used for fast cooking such as toast. Use a lower setting to cook thicker foods such as chicken after it has been browned on the high setting.

You should remember to turn the food regularly.

You should not use the grill to keep food warm as it will continue to cook the food.

The grill pan should be used on the shelf without the metal plate underneath it. The shelf can be positioned in any of the runner positions. You can reverse the grill pan grid to suit different types of food.

If you close the door whilst the grill burner is lit, it will go out and you will hear a continuous 'sparking'. The burner will automatically re-light when you open the door.

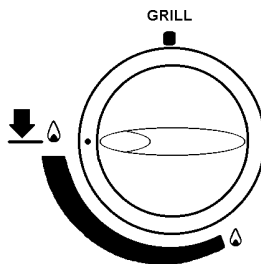

## For your safety

You must keep the grill door open when the grill burner is lit.

Accessible parts may be hot when the grill is used. Young children should be kept away.

Never cover the grill pan or grid with foil as this can lead to grill fires.

## Cooking positions

Most food should be cooked on the grid in the grill pan. You can turn the grid over to suit different thicknesses of food.

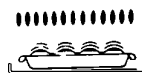
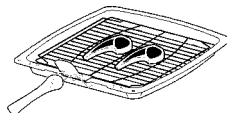
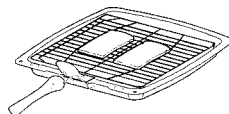

You can place some dishes straight on the grill shelf. This is useful when you are browning the top of food such as cauliflower cheese.

## Preheating

You don't usually need to preheat the grill. You may wish to preheat it for a couple of minutes when you are cooking steak or browning food.

## Putting food on the grid

Place food such as toast, tea-cakes and muffins towards the centre of the grid. If you put food outside this area it may require rotating during cooking.

Place food which needs a more gentle heat, such as tomatoes or mushrooms towards the edge of the grid.

Arrange meat, meat products and fish to suit their thickness and how you like them cooked.

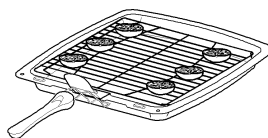
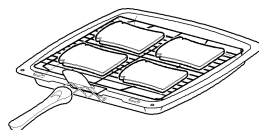

## Grill shelf

The grill shelf can be slotted into place in either of two positions. You can use the shelf in position two or on the base of the grill compartment. You can only use these two shelf positions when you want to use the grill. For safety the shelf will only pull out so far. If you want to remove the shelf completely pull it forward as far as it will go, raise the front edge and lift it out. To put the shelf into a different position, keep the front edge raised, slot the shelf onto the runner, lower the front edge and slide the shelf in.

You should use the shelf without the metal plate when grilling.

Use shelf position two when toasting and adjust the height of the grid to suit.

Shelf positions are counted from the top downwards.

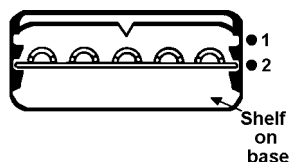

### For your safety

Always remove the grill pan before attempting to adjust the shelf position. Oven gloves should be used when removing or pulling the shelf in and out.

For hygiene and safety reasons this appliance should be kept clean at all times. A build-up of fats or other foodstuffs could result in a fire, especially in the grill pan.

## The grill pan and handle

The grill pan is supplied with a removable handle.

To attach the handle, place the wirework under the cut out in the pan so that the metal plate hooks over the top of the grill pan.

Slide the handle to the left and over the central bump on the grill pan.

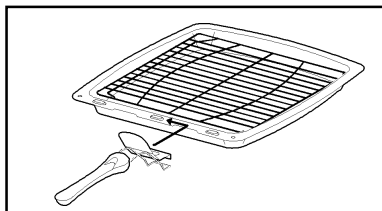

Ensure the handle is correctly located. It is not necessary to remove the grill pan handle during grilling.

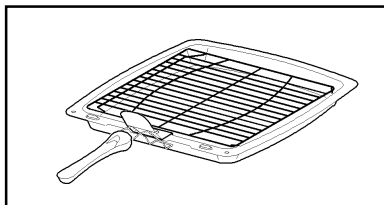

Place the grill pan on the shelf so that the pan is positioned centrally beneath the grill.

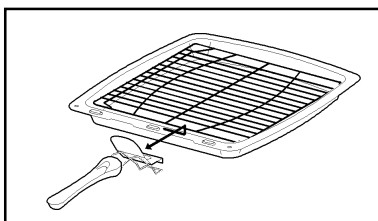

To remove the handle, slide the handle to the right and lift the handle away from the cut out on the grill pan.

### Note

If you require an additional handle for your grill pan, this can be ordered from your local Service Force Centre by quoting part number 311479800\6.

To check the progress of the food when using the grill you should withdraw the grill pan on the shelf to attend to food. After removing the grill pan you can rest it on a heat resistant work surface if you need to.

## Plate warming

You can use the grill compartment to warm plates while the oven is on.

**Do not** place plates to warm under the grill when it is on as this may damage the plates.

## The oven

### For your safety

Never leave the appliance unattended when the oven door is open.

Before you use the oven you should wipe it out with a damp cloth. This will remove any dust.

We suggest that you run the oven without food for 10 - 15 minutes at Gas mark 7 to burn off any residue from the surface. During this period an odour may be emitted, it is therefore advisable to open a window for ventilation.

### Heat zones

There are zones of heat within the oven. The temperature in the middle is the gas mark you have chosen.

The top of the oven is slightly hotter and the lower shelf slightly cooler. The base of the oven is quite a lot cooler. You can make use of these heat zones when you are cooking foods requiring different temperatures all at the same time. You can use the base of the oven to warm plates.

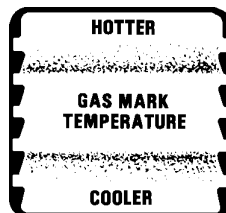

If you are cooking more than one tray of similar items, for example cakes or biscuits, swap the trays around during cooking. Or you could remove the top tray when the food is cooked and move the lower tray to the higher shelf to finish cooking.

### Preheating

You do not need to preheat the oven for casseroles and so on.

Preheat the oven for baking or when you are cooking sensitive food such as Yorkshire puddings, soufflés and yeast mixtures.

When you are cooking or reheating frozen or chilled food read the instructions on the packaging.

When you need to preheat the oven, we recommend you do so for 20 minutes.

## Oven shelves

The two oven shelves can be slotted into place in any of 5 positions. For safety the shelves will only pull out so far. If you want to remove a shelf completely, pull it forward as far as it will go, raise the front edge and lift it out.

To put the shelf into a different position, keep the front edge raised, slot the shelf onto the runner, lower the front edge and slide the shelf in.

The shelf positions are counted from the top downwards and recommended shelf positions are given in the cooking charts on pages 17, 18 and 19. When cooking always try to leave at least one runner position between shelves to allow the heat to circulate properly.

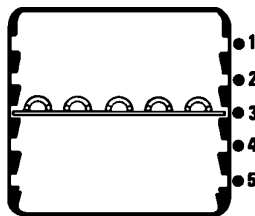

The recommended shelf positions given in the oven cooking charts give the best results.

When you only need to use one shelf you can store the other shelf above or below the one you are using where there is more space.

Use the shelf with the metal plate in a higher runner position when cooking on two levels.

## Baking trays and dishes

	<b>For your safety</b>	
	Never place cooking dishes, trays and so on over the oven burner. This will damage the oven as well as the ovenware and possibly the cabinet underneath the oven.	
	Leave a gap of 13mm (½") between all dishes and the sides of the oven so the heat can circulate properly.	
	<b>Do not</b> push dishes too far back as food will burn if it overhangs the burner flames.	

For the best results we recommend that you use a baking tray which is 310mm (12") square. If you use a tray or tin which is larger than this, you may need to turn it around during cooking.

Place single dishes on the centre of the shelf. You may need to turn large items around during cooking.

## Roasting

For best results we recommend open roasting using minimal fat or oil to prevent splashing.

It is not necessary to cover meat or poultry or wrap food in foil when roasting as this restricts the circulation of heat and will lead to extended cooktimes.

If you are using a roasting bag or cover chicken breast with foil, be prepared to allow an extra 10 - 15 minutes for each 1/2kg (1lb).

When cooking large items such as turkeys, the use of foil may be required to prevent the breast becoming dry before the rest of the bird is fully cooked.

## Condensation

Condensation may form on the oven. This is quite normal and nothing to worry about. The condensation forms when heat and moisture are present, for example during cooking. Whenever possible try to make sure that food which contains a lot of moisture for example casseroles are covered. If you do notice any condensation, wipe it up straight away.



## Oven cooking chart

These instructions are for cooking in the oven after it has been pre-heated for 20 minutes.

When you are using both shelves, use the shelf with the metal plate in the higher position.

If you are cooking more than one tray of similar items, for example cakes or biscuits, swap the trays around during cooking or you can take the top tray out of the oven when the food is cooked and move the lower tray to the higher shelf to finish cooking.

Always leave at least one shelf position between shelves to allow heat to circulate.

The recommended shelf positions give the best results.

Put the dishes in the centre of the shelf.

You can change the gas marks and cooking times to suit your own tastes.

It is important to check that food is piping hot before serving.

Food	Gas mark	Shelf position	Approximate cooking time
Roasting meat: Beef	5	4*	Rare: 20 mins. per ½kg (1 lb) and 30 mins. Medium: 25 mins. per ½kg (1 lb) and 25 mins. Well Done: 30 mins. per ½kg (1 lb) and 30 mins.
Lamb	5	4*	Medium: 25 mins. per ½kg (1 lb) and 25 mins. Well Done: 30 mins. per ½kg (1 lb) and 30 mins.
Pork and Veal	5	4*	Medium: 30 mins. per ½kg (1 lb) and 30 mins. Well Done: 35 mins. per ½kg (1 lb) and 35 mins.

Thoroughly thaw frozen joints before cooking them.

\* Recommended position for shelf with metal plate.

Food	Gas mark	Shelf position	Approximate cooking time
Poultry:			
Chicken	5	4*	20 mins. per ½ kg (1 lb) and 20 mins.
Turkey below 4.5kg (10lbs)	4	5	25 mins. per ½ kg (1 lb) and 25 mins.
over 4.5kg (10 lbs)	4	5	15 mins. per ½ kg (1 lb) and 15 mins.
Duck and duckling	5	4*	25 mins. per ½ kg (1 lb)
Stuffed poultry	Cook as above but calculate weight including stuffing		

Thoroughly thaw frozen joints before cooking them.

The times given above are for open roasting in a preheated oven. If you cover the food with foil or a lid allow an extra 10 - 15 minutes for each ½kg (1lb).

Yorkshire pudding	- large	7	2*	25-30 mins.
	- individual	7	2*	15-25 mins.
Cakes:				
	Christmas cake 230mm (9")	2	5*	4-5 hours.
	Rich fruit cake 180mm (7")	2	5*	2¼ hours.
	205mm (8")	2	5*	2½-2¾ hours.
	Madeira, 180mm (7")	4	5*	60 mins.
	Small cakes	5	1* & 4	15-25 mins.
	Scones	7	1* & 4	10-20 mins.
	Victoria sandwich			
	180mm (7")	4	2* & 4	20-30 mins.
	205mm (8")	4	2* & 4	20-35 mins.

\* Recommended position for shelf with metal plate.

Food		Gas Mark	Shelf Position	Approximate cooking time
Pastries:	Plate tart (shortcrust)	6	2*	25-35 mins.
	Fruit pie (shortcrust)	6	2*	25-35 mins.
	Mince pies (flan pastry)	5	1* & 4	20-25 mins.
	Profiteroles (choux pastry)	4	2	25-30 mins.
To help pastry brown on the underside cook on a metal plate, or if plates are flat and have no rim underneath, place on baking tray to cook.				
Puddings:	Milk puddings	2	3	1½-2 hrs.
	Baked sponge pudding	4	4*	45-60 mins.
	Baked custard	3	2	50-60 mins.
Yeast mixtures:	Bread 0.45kg (1 lb loaves)	8	3*	30-40 mins.
	0.90kg (2 lb loaves)	8	3*	30-40 mins.
	Rolls and buns	8	2*	15-20 mins.

Note: You must soak dried beans then boil them in an open pan for 15 minutes before you add them to any dish.

\*Recommended position for shelf with metal plate.

## Slow cooking

The slow cook setting gives a very low heat in the oven. It is particularly useful when you are cooking soups, stews and casseroles because the long slow cooking will make cheaper, tougher cuts of meat more tender.

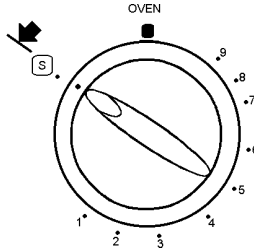

Some foods such as pastry and biscuits are not suitable for slow cooking because the temperature is too low.

Cover all food during cooking to prevent it from drying out. You can uncover food for the last half hour if it is normally served golden brown.

## Food preparation-slow cooking

### Joints of meat and poultry

- **Do not** cook meat joints over 2.7kg (6lb).
- **Do not** cook poultry over 2kg (4lb 8oz).
- Cook on the middle shelf of the oven or above.
- Cook stuffing separately.
- Cook for at least 6 hours.
- Only cook joints of pork if you can make sure, by using a meat thermometer, that the temperature inside the joint is at least 88°C.
- For good air circulation always stand joints on a rack in the roasting tin or casserole
- Thaw all frozen meat and poultry before you cook it.
- Prime cuts of meat do not benefit from slow cooking.
- Cut off unwanted fat and skin unless it is browned first.

## Soups, casseroles and stews

- **Do not** cook casseroles over 2.7kg (6lb).
- **Do not** cook two (1.8kg) (2lb) casseroles on slow cook setting at the same time.
- Cook in the middle of the oven or above.
- Cover food with a tight fitting lid or tin foil.
- Cook for up to 9 hours.

## Vegetables

- Cut into small pieces.
- Dried beans must be pre-soaked then boiled in an open pan for 15 minutes before adding to any dish.
- To prevent vegetables from discolouring, add lemon juice.
- Place vegetables under meat in casseroles.
- Cover food with a tight fitting lid or tin foil.
- Cook for up to 6 hours.

## Milk puddings

- Make the pudding in the usual way.
- For delicate puddings such as egg custard, place the dish in a bain marie and cover the dish with tin foil.
- Cook for 2 - 4 hours.

## General points for slow cooking

### Frozen foods

Thaw thoroughly before cooking.

### Thickening

Toss meat in flour for casseroles. Alternatively blend cornflour with water and add it at the end of cooking.

### Flavouring

Flavours are held in the food because there is little evaporation. Adjust flavouring at the end of the cooking time.

## Liquid

Use slightly less liquid as there is little evaporation during cooking.

## Milk and milk products, for example cream

Add these towards the end of cooking to prevent them from curdling.

## Reheating

Cool left over food quickly and then put it in the fridge.

**Do not** reheat food using the slow cook setting. Reheat food in the usual way or in a microwave.

Only reheat food once.

## The Electronic Timer

Please note that this is a 24 hour clock, for example 2pm is shown as 1400.

In the following pages we explain how to set the controls. Read through them until you're familiar with the procedure.

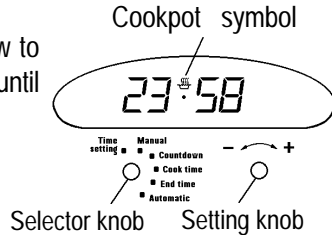

If the oven is switched off on the wall, or there is a loss of power, the clock will stop and you will not be able to use the oven. When you first switch the electricity supply on, the timer display will flash.

During the hours of 10 p.m. (22.00 hrs) and 6 a.m. the display will glow dim. If a function is selected the display will glow brighter until the function is complete. It will then revert back to the dim mode.

### To set the time of day

Turn and hold the selector knob to 'Time Setting'.

The cookpot is showing (  ). Set the correct time by turning the setting knob clockwise. Adjust the time by turning the setting knob in either direction.

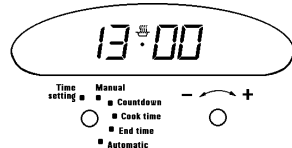

### To use the Countdown

Turn the selector knob to 'Countdown'.

Turn the setting knob clockwise until the display shows the time you want. Our diagram shows the timer set to 5 minutes.

When you are using the countdown you can make the clock show the time of day by turning the selector knob to 'Manual'.

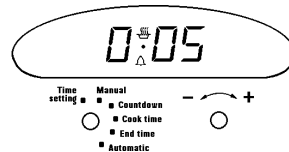

At the end of the timed period an alarm will sound. Switch off the alarm by turning the selector knob to 'Manual'.

## Automatic control

When you use the automatic controls for the first time it's probably best to choose a time when you are at home. That way you can check to make sure you've set everything correctly and you'll feel much more confident when you are away from home in the future.

## Setting the controls for automatic use

This is very easy. All you have to do is work through the steps below. The clock will work out the rest for itself.

1 Is the electricity supply on?

2 Is the clock showing the correct time?

To adjust turn and hold the selector knob to 'Time Setting' and turn the setting knob in either direction.



3 How long will the food take to cook?

Turn the selector knob to 'Cook Time'. Then turn the setting knob until the length of time you want the food to cook shows in the display. The maximum cooking time is 23 hours and 59 minutes. Auto will show in the display.





- 4 What time do you want the food to be cooked by? Turn the selector knob to 'End Time'. Turn the setting knob until the time the oven is to switch off shows in the display. The cookpot (  ) will go out.



The 'End Time' must not be more than 23 hours 59 minutes from the time of day. For example if the time of day is 9.00 am the latest 'End Time' will be 8.59 am the next day.

'Auto' will now glow in the display.

- 5 Set to automatic. Turn the selector knob to 'Automatic'. The time of day will show in the display.
- 6 Turn on the oven control. Turn the oven control to mark 9 then to the gas mark you want.

The time shown on the chart gives an example of setting the automatic controls when the time is 9.00 am, the food is to be cooked for 2½ hours and the food is needed at 6.00 pm (1800 hours).

The clock will work out what time the oven will switch itself on and it will turn the oven off at the end. Once the automatic sequence is finished there will be an alarm and the 'Auto' symbol flashes to remind you that you need to set the oven for manual operation. To do this turn the selector knob to 'Manual'.

Turn off the oven control.

## To cancel an automatic programme

If you change your mind and want to cancel a programme that you have set turn the selector knob to 'Cook time' and turn the setting knob until 0.00 shows in the display.

Turn the selector knob to 'Manual'.

## Hints and tips for automatic cooking

- 1 Check the instructions for setting the automatic controls until you are familiar with the timer operation.
- 2 If the oven has been used, allow it to cool completely before using for automatic cooking.
- 3 You should leave food in the oven for as short a time as possible before automatic cooking starts.
- 4 **Do not** leave food to stand in the oven when it has finished cooking. You should remove it and if it is not going to be eaten at once, cool it quickly.
- 5 If you cannot remove food from the oven as soon as it is cooked make sure that the food is covered.
- 6 Choose perishable foods carefully, especially during warm weather.
- 7 Food should be fresh and preferably straight from the refrigerator.
- 8 Joints of meat and poultry must be completely thawed.
- 9 Dishes containing left over cooked meat or poultry should not be cooked automatically if there is a delay period.
- 10 Choose dishes which require approximately the same cooking time. Slight variations may be allowed by:-
  - i) placing foods in larger or smaller containers
  - ii) using more or less liquid
  - iii) cutting fruit or vegetables into larger or smaller pieces.These will give longer or shorter cooking times respectively. Further temperature adjustments can be made by placing the foods higher or lower in the oven as the top of the oven is hotter than the bottom.
- 11 Arrange shelf positions to suit dishes and choose dishes which will fit into the oven together.
- 12 As food may be standing for some time in the oven, cover dishes with foil or a lid where possible, and in the case of roast potatoes and joints of meat, brush with a little fat or oil. Lemon juice may be added to fruit and vegetables to prevent browning.
- 13 Cream should be added just before serving.
- 14 If alcohol is used fermentation can occur.
- 15 Green leaf vegetables which take only a short time to cook, should not be placed into the oven with the automatic meal. It is far better to cook them in a pan on the hotplate whilst dishing up the rest of the meal.

## Care and cleaning

### For your safety

For hygiene and safety reasons you must keep this gas oven clean. A build up of fat or other foodstuff could cause a fire.

Try to mop up spills and splashes as soon as they happen.

But be careful as parts of the appliance will be hot.

**Do not** use any polishes, caustic cleaners, abrasives, washing soda or soap powder except those recommended in this booklet.

Please note: If we recommend you use hot soapy water we mean hot water with washing up liquid in it and not any other cleaning appliance.

If you own a dishwasher please read the operating instructions for the machine before you wash any part of your appliance in it.

Clean your oven regularly using a cloth that has been wrung out in hot soapy water. Rinse and polish it dry using a soft cloth.

When you remove parts of your oven for cleaning **do not** plunge them into water whilst they are very hot as this may damage the finish of the parts.

You must not remove the control knobs when cleaning the control panel.

### The grill

Clean the grill compartment, the shelf, grill pan and handle, grid, and the inner grill door while they are still slightly warm. This way you can easily remove any splashes and spills. Clean them with a cloth that has been wrung out in soapy water. You may use mild abrasives such as 'Cif'. For more stubborn marks you may occasionally need to use a soap filled pad such as 'Brillo'.

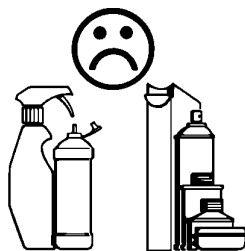

## The oven

The inside of the oven is finished in vitreous enamel. You should clean the oven regularly using hot soapy water and mild abrasives or a soap filled pad such as 'Brillo'. If you use any oven cleaners they must have the Vitreous Enamel Development Council (VEDC) seal of approval. Follow the instructions on the cleaning agent and protect the oven burner with aluminium foil to prevent it becoming blocked.



- 1  **Do not** overfill dishes or they will boil over. 
- 2  **Do not** use dishes too high in the oven. If you do they may stick to the oven roof. 
- 3  Cover your roasting tins with foil. This will prevent fat splashing. 
- 4  Use a roasting tin which is just large enough for the meat and potatoes. This will help to reduce fat splashing. 
- 5  Dry any vegetables that you are going to roast. If they are wet there will be more fat splashing. 

## General

Clean the oven shelves, meat tin and the oven door while they are still slightly warm. This way you can easily remove any splashes and spills. Wipe the base with a cloth that has been wrung out in hot soapy water. You may use mild abrasives.

## Cleaning between the outer and inner door glass

You can remove the glass from the oven and grill doors if you need to. The grill door is fitted with a trim. You must note the correct position of the trim when you remove the grill door glass.

To remove the outer glass

- 1 Open the door so you can get at the two cross head screws on the top of the door.
- 2 Loosen these two screws using a pozidrive screwdriver.

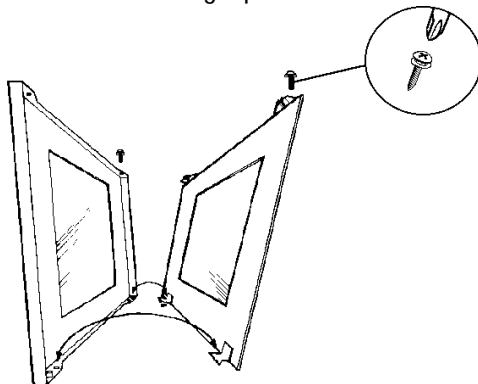

- 3 You should hold the door glass securely in place with one hand, whilst removing the screws completely, with the other hand. If you do not do this, the door glass could fall forward. Still holding the door glass, remove the trim from the top of the grill door. Note the correct position of the grill door trim. The oven door does not have a trim.
- 4 Using both hands, gently tilt the top of the door glass towards you. Lift it slightly to disengage the locators at the bottom of the door.
- 5 Clean the outer and inner glass using hot soapy water and mild abrasives such as 'Cif'.
- 6 Replace the glass by holding it in both hands and gently placing the locators into the holes of the brackets at the bottom of the door. Push the top of the glass towards the door, and make sure the screw location holes line up. Replace the trim on top of the grill door making sure that it is correctly positioned. You can check this by looking through the air gap on the top of the door and checking that the screw location holes line up.
- 7 Hold the glass in place with one hand and replace the cross head screws into the location holes, with the other hand.
- 8 Tighten the screws using a pozidrive screwdriver. Close the door.

## What is wrong and why?

We strongly recommend that you carry out the following checks on your oven before calling a Service Engineer.

### Problem

#### **The oven or grill will not light.**

#### Check

- Check that the oven is switched on at the wall.
- Check that the timer is set to 'manual' (See page 23).
- Check that there has not been a power failure. If the electricity supply has been interrupted or you have switched the oven off at the wall the grill may have cut out before the cooling fan has cooled the oven down. Switch the oven on at the wall until the cooling fan has cooled it down.
- Check that there is not a problem with your gas supply. You can do this by making sure that other gas appliances such as your central heating or gas fire are working.

### Problem

#### **Food is cooking too quickly or too slowly.**

#### Check

- Check that you are using the recommended gas marks and shelf positions. See pages 17, 18 and 19. Be prepared to adjust the gas mark up or down to achieve the results you want.

### Problem

#### **The oven is not cooking evenly.**

#### Check

- Check that the oven is installed properly and is level.
- Check you are using the recommended temperatures and shelf positions.
- If you are using a tin or tray which is larger than the one we recommend, be prepared to turn it round during cooking
- If you are cooking a large item be prepared to turn it round during cooking.

**Problem****Having difficulty cleaning any part of the oven.****Check**

- Check that you are following the instructions for care and cleaning (See page 27).

**Problem****The oven lights do not work.****Check**

- Check that the oven is not set for automatic cooking. The lights will illuminate when cooking begins.
- If you have had your oven for some time you may need to replace an oven light bulb. (See page 32).

**Problem****The timer does not work.****Check**

- Check that the timer instructions are being closely followed. (See page 23).

**Problem****The oven or grill burner flame is unstable/noisy.****Check**

- Check that the burner flames stabilise after a few minutes. It may be that the appliance needs to adjust to room temperature.

## Replacing an oven light bulb

You need a 25 Watt small Edison screw with a temperature rating of T300.

- Make sure the oven is cool before you replace a bulb.
- Unplug the appliance.
- Open the oven door and remove the oven shelves.
- Pull the glass bulb cover towards you and then pull it off.
- Unscrew the bulb by turning it to the left.
- Fit a new bulb and then replace the glass bulb cover.
- Replace the oven shelves.
- Plug the appliance back into the electricity supply.
- Re-set the time of day.

The oven light bulb is not covered by the manufacturers guarantee.

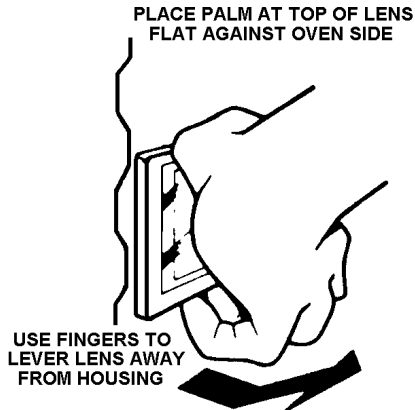



## Service and spare parts

In the event of your appliance requiring service or if you wish to purchase spare parts please contact your local Service Force Centre by telephoning

**08705 929929**

Your call will be routed to your local Service Force Centre covering your postcode area.

Customers in Ireland should telephone (01) 4090753.

Before you call an engineer check through the information under the heading 'What is wrong and why?'

**In-guarantee customers should ensure that the checks under the heading 'What is wrong and why?' have been made as the engineer will make a charge if the fault is not a mechanical or electrical breakdown.**

**Please note that it is necessary to provide proof of purchase for any in-guarantee service calls.**

When you report a problem try to describe the nature of the fault. Always give your appliance's full name, model and serial number. Make a note of this information in this space:

Name:

Model Number:

Serial Number:

P.N.C. Number:

**For your safety**

Maintenance must only be carried out by a competent /qualified person. **Do not** try to repair or alter/modify the appliance yourself as this could be dangerous.

We recommend that your appliance has an annual gas safety check carried out by our approved service organisation.

**Customer Care Department**

For general enquiries concerning your Electrolux appliance or further information on products, you are invited to contact our Customer Care Department by letter or telephone as follows:

Customer Care Department  
Electrolux  
55-77 High Street  
Slough  
Berkshire  
SL1 1DZ

Tel: 08705 950950 \*

\* calls to this number may be recorded for training purposes.

**The Gas Consumers' Council**

The Gas Consumers' Council (GCC) is an independent organisation which protects the interests of gas users.

If you need advice, you will find the telephone number in your local telephone directory under Gas.

# INSTALLATION INSTRUCTIONS

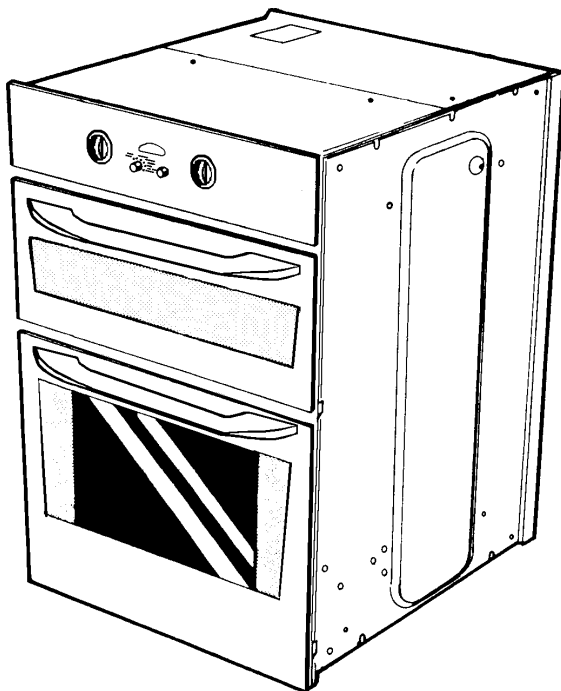

Serial number on front  
frame. Data badge on  
rear of electric panel

Please note that the handle may differ in type and shape from that shown in the diagram.

## **For your safety**

Where applicable Natural Gas and L.P. Gas versions of this appliance are available.

Check that this model is suitable for the type of supply available.

In the interest of safety this appliance must be installed and/or serviced by a competent person, as stated in the Gas Safety (Installation and Use) Regulations Current Editions.

# TECHNICAL DATA

## DIMENSIONS

	<i>Height</i>	<i>Width</i>	<i>Depth</i>
Overall	885	595	595
Flexible Gas Pipe			
Minimum Cabinet	874	560	575
Solid Gas Pipe			
Minimum Cabinet	874	560	560
Maximum Cabinet	879	570	N/A
Weight of Appliance	45kg		
Minimum Clearance top of Appliance to Roof of Cabinet	3mm (1/8")		

## CONNECTIONS

Gas	Flexible Hose	Rear top right hand side of appliance Rc½ (½" B.S.P. Female).
	Solid Pipe	Right hand side of appliance above grill Behind control panel Rc¼ (¼" B.S.P. Female)
Electrical		Rear of appliance at bottom left hand side 240V a.c. 50Hz Mains 3 core cable and moulded plug fused to 3 amp.

## GENERAL

Timer	Eaton EL191
Pressure test point	Top right hand corner behind fascia.
Solenoid valve	Teddington SOVRBB01G

## IGNITION

Spark Generator	Flame Suppressed H.T. spark 240V APCO D9805
Spark Gap	3-4mm

## GRILL

	<i>Natural Gas</i>	<i>L.P.Gas</i>
Burner	Steel tubular burner with expanded metal frets.	
Heat Input	2.8kW (9556 Btu/h)	2.8kW (201 g/h)
Injector Marking	123	089

## OVEN

	<i>Natural Gas</i>	<i>L.P.Gas</i>
Burner	Sheet metal construction mounted transversely at rear of oven.	
Heat Input	2.4kW (8189 btu/h)	2.4kW (172 g/h)
Injector Marking	108	078
Flame Supervision Device	Diamond 'H' G.S.D. 100/28	Diamond 'H' G.S.D100/30
Thermostat	Diamond 'H' 1100/141/B2	Diamond 'H'1100/142/B2
Thermostat By-Pass Marking	74	79

## **IMPORTANT - SAFETY REQUIREMENTS**

This appliance must be installed in accordance with the Gas Safety (Installation and Use) Regulations Current Editions. Detailed recommendations are contained in the following British Standard Codes of Practice - BS.6172, BS.5440: Part 2 and BS.6891. All British Standards must be 'Current Editions'.

## **PROVISION FOR VENTILATION**

This appliance is not connected to a combustion products evacuation device. It shall be installed and connected in accordance with the current installation regulations. Particular attention shall be given to the relevant requirements regarding ventilation.

The room containing the appliance should have an air supply in accordance with BS. 5440: Part 2 Current Edition. All rooms require an openable window or equivalent and some rooms will require a permanent vent as well. For room volumes up to 5m<sup>3</sup> an air vent of 100cm<sup>2</sup> is required: for room volumes between 5m<sup>3</sup> and 10m<sup>3</sup> an air vent of 50cm<sup>2</sup> is required. If the room has a door that opens directly to the outside, no air vent is required. For room volumes that exceed 11m<sup>3</sup> no air vent is required. If there are other fuel burning appliances in the same room, BS.5440: Part 2 Current Edition should be consulted to determine the requisite air vent requirements.

Prolonged intensive use of the appliance may call for additional ventilation, for example opening a window, or more effective ventilation, for example increasing the level of mechanical ventilation where present.

## LOCATION OF APPLIANCE

The appliance may be located in a kitchen, a kitchen/diner or bedsitting room, but not located in a bathroom, shower room or garage.

**It is essential that there is a minimum clearance of 3mm between the top surface of the appliance and the inside top of the cabinet.** The unit must be fitted into a cabinet conforming to Fig. 1. The following internal dimensions are particularly important.

	Height	874.....Minimum	879.....Maximum
	Width	560.....Minimum	570.....Maximum
Solid Pipe	Depth	560..... Minimum	N/A.....Maximum
Flexible Pipe	Depth	575.....Minimum	N/A.....Maximum

**NOTE:** Where a cupboard door with a handle is situated above the appliance, we recommend a minimum clearance gap of 5mm between fascia top trim and door.

L.P.G. cookers **MUST NOT** be installed below ground level, i.e. in a basement.

Fig.1

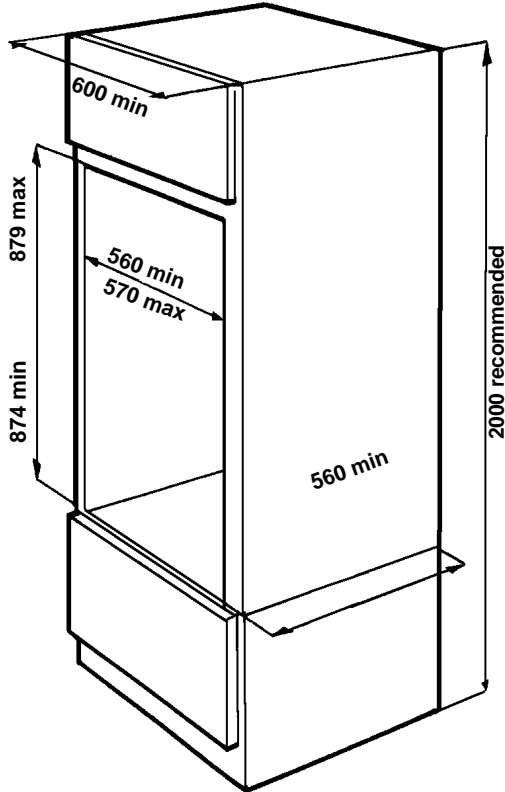

# INSTALLATION

Flexible Pipe Installation.

## FITTING THE APPLIANCE AND CABINET

It is recommended that a  $\frac{3}{8}$ " 1100mm long angle bayonet flexible hose (B.F.S.) and a  $\frac{1}{2}$ " straight socket (B.F.S.) be used for the installation. However any approved hose of the correct length can be used.

**IMPORTANT:** Flexible tubing used must comply with BS 669 current editions. L.P.G. flexible connections must be of a type suitable for L.P.G. and capable of operation up to 50mbar and carry a red stripe, band or label.

**NOTE:** Only liquid sealants can be used in threaded gas connections. **Do** not use P.T.F.E. tape.

- 1 Make suitable arrangements for gas and electric supplies into the installation site. Preferably a junction box or a 3 pin earthed socket should be situated at the back of the cabinet below the oven.
- 2 The electrical connection to the appliance is at the rear bottom right hand side; the junction box or socket should be positioned accordingly.
- 3 Fit the cabinet as Fig.1, make sure that it is level.
- 4 When unpacking the appliance keep it on it's polystyrene base until it is put into the cabinet to avoid damage.

**NOTE:** It is imperative that the appliance is left in the base to protect both the appliance and the floor. Do not allow young children to play with any part of the packaging.

- 5 Remove the oven and grill doors (See section B on page 43). Remove the fascia panel (See section A on page 42).
- 6 If the gas supply bayonet and wall fixing bracket are to be located behind the appliance it must be located in the shaded area as indicated in Fig.3.
- 7 Connect flexible hose to the gas inlet supply block see Fig.3. The hose should be long enough to allow the appliance to be withdrawn from the cabinet.
- 8 Position the appliance in front of the cabinet and run the supply cable (See Section 2) through the cabinet and connect to the junction box or socket. Ensure that the supply is isolated at this stage. Connect flexible hose to the bayonet connector.
- **N.B. Two people will be required to carry out the lifting procedure.**

Warning: Do not attempt to lift this appliance by the handles.

- 9 Lift the appliance into the cabinet making sure the hose and cable are not trapped. Push the appliance as far back as it will go.
- 10 Centralise and fix the appliance using the six wood screws provided, in the position indicated in Fig.2.
- 11 Carry out gas soundness check.

**NOTE:** Check gas supply pressure before fitting fascia (See SECTION 3).

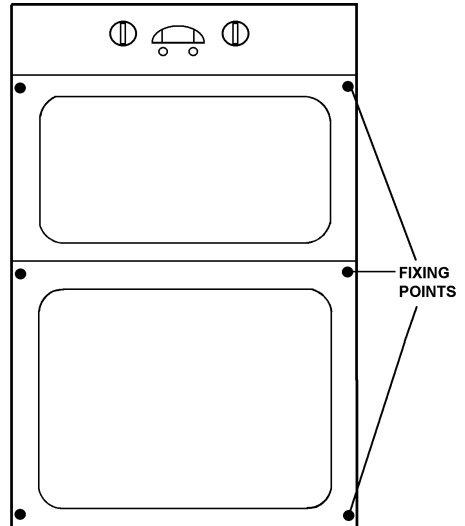

Fig.2

# INSTALLATION Solid Pipe Installation

## FITTING THE APPLIANCE AND CABINET.

- 1 Make suitable arrangements for gas and electrical supplies into the installation site. Preferably a junction box or a 3 pin earthed socket should be situated at the back of the cabinet below the oven.
- 2 Fit cabinet as Fig. 1, making sure that it is level.
- 3 When unpacking the oven keep it on it's polystyrene base until it is put into the cabinet to avoid damage.  
NOTE: It is imperative that the appliance is left in the base to protect both the appliance and the floor.  
Do not allow young children to play with any part of the packaging.
- 4 Remove the oven and grill doors. (See section B on page 43).

5 Solid gas pipe installation:

- i) Remove the fascia control panel (See section A on page 43).
- ii) Slacken and remove the union nut on the gas supply elbow on the right hand side of the control panel. See Fig.7.
- iii) Remove the two screws on the gas inlet block Fig.3.
- iv) Withdraw the gas inlet block and pipe assembly from the back of the appliance
- v) Remove the union elbow from the inlet block and pipe assembly. The elbow will be required in the final installation.
- vi) The union elbow should be connected to the gas supply pipe via a standard 1/4" B.S.P. straight connector.

GAS INLET SUPPLY BLOCK

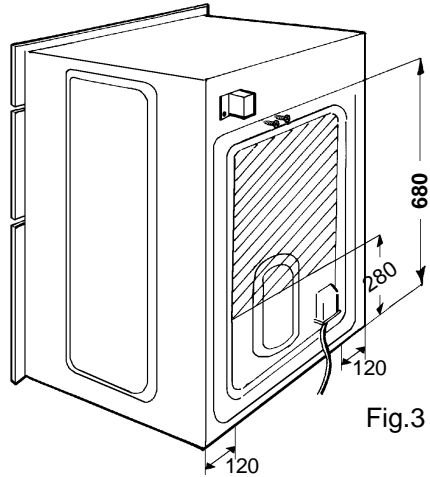

Fig.3

- 6 Install the gas supply pipe on site complete with the union elbow (See Fig.4). Note the orientation of the elbow, the connection must be upwards.
- 7 Position the appliance in front of the cabinet and run the supply cable (See Section 2) through the cabinet and connect to the junction box or socket. Ensure that the supply is isolated at this stage.

● **N.B. Two people will be required to carry out the lifting procedure.**

Warning: Do not attempt to lift this appliance by the handles.

- 8 Lift the appliance into the cabinet making sure the gas supply pipe enters the duct in the rear of the appliance and the cable is not trapped by the appliance. Push the appliance as far back as it will go. Ensure the supply pipe comes through the control panel and pull through any slack cable.
- 9 Centralise and fix the appliance to the cabinet using six wood screws in the position indicated in Fig.2.
- 10 Tighten the union nut into the supply elbow.
- 11 Carry out gas soundness check .

**NOTE:** Check supply pressure before fitting fascia (See Section 3).

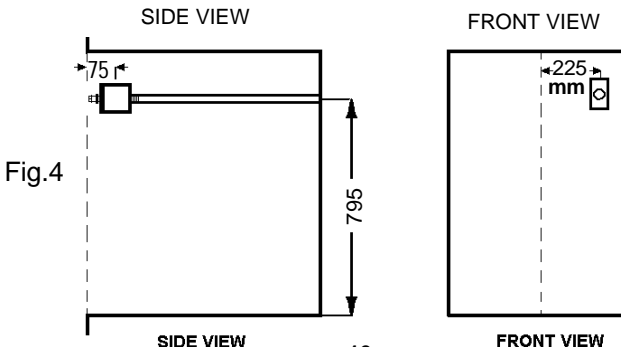

Fig.4



## 2. CONNECTION TO ELECTRICITY SUPPLY

**WARNING: This appliance must be earthed, do not earth this appliance to the gas supply piping.**

This appliance must be connected to a 220V-240V a.c. 50Hz supply which incorporates a 3 ampere fuse. If any other type of plug is used it should incorporate a 5 ampere fuse in either the plug or adapter or at the distribution board. The appliance is supplied with 2 meters (6.5 ft) of 5 ampere 3 core cable, fitted with a moulded plug. If this proves insufficient to allow the appliance to be plugged into the nearest supply socket, the supply cable can be either:-

- i) Replaced totally by a longer cable at least 0.75mm<sup>2</sup> nominal cross sectional area (24/0.2).
- ii) Extended by using a B.E.A.B. approved 3-way sealed flex connector with integral flex clamps.

DO NOT EXTEND THE CABLE USING PLASTIC OR CERAMIC CONNECTION TERMINAL BLOCKS AND/OR INSULATION TAPE.

If the supply cable is replaced it is recommended that the ends of the new cable all be cut to the same length 60mm, any excess wire being stored inside the mains terminal see Fig.5.

Should the supplied cable be required to be threaded through small apertures in the cabinets it can be removed from the mains inlet terminal block see Fig.5.

If the supplied plug is cut off dispose of it safely as it will be a shock hazard if inserted into a 13 amp socket elsewhere in the house.

To fit a 3 pin 13 amp plug to the end of the appliance cable (Fig.6). Connect the wires as follows:

BROWN to the live terminal.

BLUE to the neutral terminal.

GREEN and YELLOW to the earth terminal.

As the colours of the wires in the mains lead of this appliance may not correspond with the coloured markings identifying the terminals in your plug, proceed as follows:

The wire which is GREEN and YELLOW must be connected to the terminal in the plug which is marked with the letter 'E' or by the earth symbol  $\perp$  or coloured GREEN or GREEN and YELLOW.

The wire which is coloured BLUE must be connected to the terminal which is marked with the letter 'N' or coloured black.

The wire which is coloured BROWN must be connected to the terminal which is marked with the letter 'L' or coloured RED.

**FIT A 3 AMP FUSE TO THE PLUG FUSE HOLDER**

## 3. PRESSURE TESTING

The pressure test point is located on the right hand side of the gas rail. Access to the test point is through a cut out in the top right hand side of the control panel see Fig. 7.

- 1 Remove the hex head plug, turn anticlockwise from the test point.
- 2 Connect the pressure gauge to the test point.
- 3 Check the supply pressure by turning the oven thermostat to Mark 9. Then turn on the electricity supply. Allow the oven burner to light and gas flow open up to full rate.

The pressure should be:-

For Natural Gas 20 mbar

For L.P. Gas 28mbar for butane, 37mbar for propane.

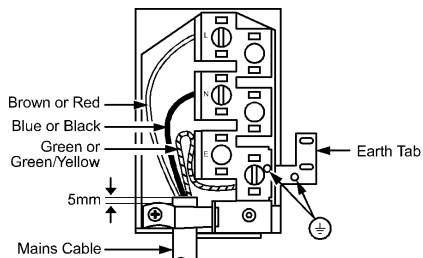

Fig .5

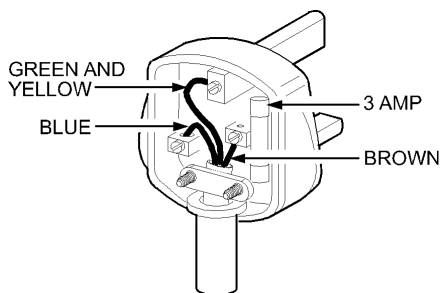
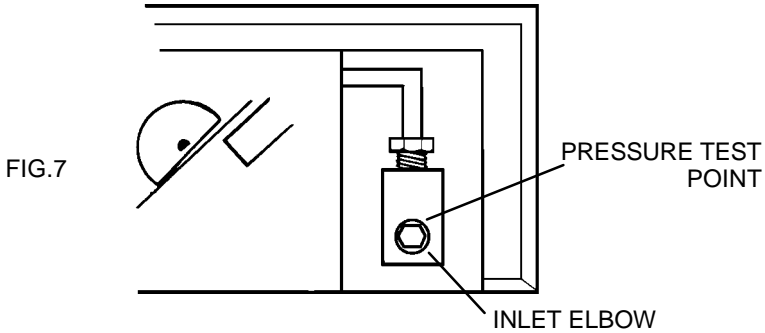

FIG.6

- 4 Turn off the electricity supply and the thermostat; disconnect the pressure gauge and replace the test point plug . Turn on gas supply and check for gas soundness.

**NOTE:** The electrical supply must be connected in order to test the pressure.



#### 4. RE-ASSEMBLE THE APPLIANCE

- 1 Re-fit the fascia panel. (See section A below).
- 2 Re-fit the oven door. (See section B on page 43).

##### A. REMOVAL OF FASCIA PANEL

- 1 Remove the gas control knobs and timer control knobs.
- 2 Remove the four screws (two each side) which are visible on the underside of the fascia. Fig.8.
- 3 Tilt the bottom of the fascia panel out over. Withdraw the fascia panel by moving it down over to disengage it from the top fixing lugs.
- 4 Replace in reverse order.

**NOTE:** To prevent the top fascia panel mounts becoming slack, it may be necessary to adjust the top fixing lugs.

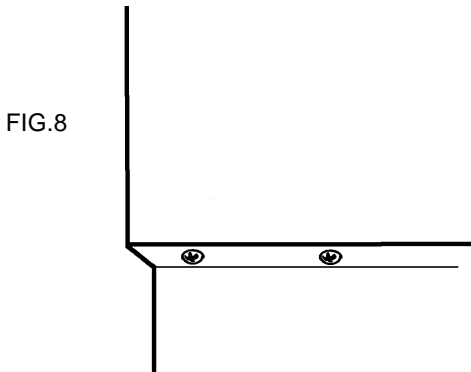

## B. REMOVAL OF OVEN OR GRILL DOORS

- 1 Open door fully.
- 2 Rotate the hinge stirrups to their forward positions (See Fig. 9).
- 3 To remove the door, clear the hinges by raising the door slightly whilst pulling towards you.
- 4 Reassemble in reverse order.

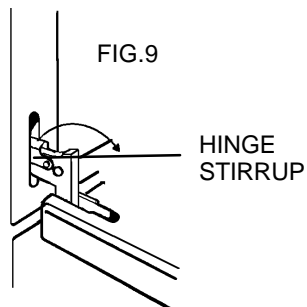

## 5. CHECKING THE GRILL

- 1 Place the grill pan containing the grid under the grill burner.
- 2 With the grill door open, turn on the grill tap, check that there is a spark from its ignition system. This should continue until the burner is alight.
- 3 There is a safety switch which shuts off the gas supply to the grill burner when the door is closed. Check that it is operational by slowly closing the grill door, the gas supply should be shut off to the burner before the grill door is fully closed.

**NOTE:** The burner will continue to spark.

## 6. TO SET THE TIME OF DAY

To set the clock (See Fig. 10).

- 1 Turn on electricity supply and ensure that the thermostat is in the off position.
- 2 Rotate left hand clock knob to the 'Time Setting' position
- 3 Set the time of day by rotating the right hand knob.
- 4 Rotate the left hand knob to the 'Manual' position.

**NOTE:** that it is a 24 hour clock.

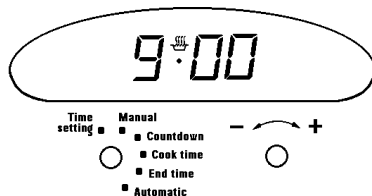

FIG.10

## **7. CHECKING THE MAIN OVEN**

- 1 Set the clock as described in section 6, the clock is now ready for manual operation.
- 2 Turn the main thermostat knob to Mk. 9 and check that there is sparking from the ignition system. This should continue until the oven burner is alight.
- 3 When the oven burner lights up the sparking should cease, there should be a low gas rate at first to the oven burner which is the flame supervision device (F.S.D.) by pass rate.
- 4 When the F.S.D. phial has heated up it opens the F.S.D. valve and the main gas stream flows to the burner.
- 5 After 1 minute check that the flame covers the full width of the burner and is stable.
- 6 Set the oven thermostat to Mk. 2, close the oven door and check that after 10 minutes the flame size has reduced.
- 7 Turn off the thermostat and check that the oven flames go out.

## **8. AUTOMATIC OPERATION**

Having set the clock up as described above, turn the left hand knob to the 'Cook Time' position , and set the right hand knob to show a cooking time of two minutes (0.02).

Turn the left hand knob to the 'End Time' position; the time shown on the display is now the time of day with two minutes added on. Rotate the right hand knob to add two minutes to this time to give a two minute delay.

Turn the left hand knob to the 'Automatic' position to complete the programming sequence, the clock now shows the time of day again with the auto neon glowing continuously.

Turn the oven thermostat on and two minutes after setting, the oven burner should commence it's lighting sequence.

Two minutes after the lighting sequence has started the timer should switch off the gas supply to the oven burner and the audible signal should sound. If the signal is continuous it may be switched off at any time by rotating the left hand knob.

Return timer to manual by rotating the left hand knob to the 'Manual' position.

## **GENERAL NOTE**

Instruct the user on how to use the appliance and its ignition system.

Refer the user to the wording in the inside cover which gives advice on the safe operation of the appliance.

# Guarantee Conditions

## Standard guarantee conditions

We, Electrolux, undertake that if within 12 months of the date of the purchase this Electrolux appliance or any part thereof is proved to be defective by reason only of faulty workmanship or materials, we will, at our option repair or replace the same FREE OF CHARGE for labour, materials or carriage on condition that:

- The appliance has been correctly installed and used only on the electricity supply stated on the rating plate
- The appliance has been used for normal domestic purposes only, and in accordance with the manufacturer's instructions
- The appliance has not been serviced, maintained repaired, taken apart or tampered with by any person not authorised by us
- All service work under this guarantee must be undertaken by your local Service Force Centre.
- Any appliance or defective part replaced shall become the Company's property
- This guarantee is in addition to your statutory and other legal rights

Home visits are made between **8.30am** and **5.30pm** Monday to Friday. Visits may be available outside these hours in which case a **premium** will be charged.

## Exclusions

### This guarantee does not cover:

- Damage or calls resulting from transportation, improper use or neglect, the replacement of any light bulb or removable parts of glass or plastic
- Costs incurred for calls to put right an appliance which is improperly installed or calls to appliances outside the United Kingdom
- Appliances found to be in use within a commercial environment, plus those which are subject to rental agreements
- Products of Electrolux manufacture which are not marketed by Electrolux

## European Guarantee

If you should move to another country within Europe then your guarantee moves with you to your new home subject to the following qualifications:

- The guarantee starts from the date you first purchased your appliance
- The guarantee is for the same period and to the same extent for labour and parts as exists in the new country of use for this brand or range of products
- This guarantee relates to you and cannot be transferred to another user
- Your new home is within the European Community (EC) or European Free Trade Area
- The appliance is installed and used in accordance with our instructions and is only used domestically, i.e. a normal household
- The appliance is installed taking into account regulations in your new country

Before you move please contact your nearest Customer Care centre, listed below, to give them details of your new home. They will then ensure that the local Service Organisation is aware of your move and able to look after you and your appliances.

France	Senlis	+33 (0) 3 44 62 29 13
Germany	Nürnberg	+49 (0) 800 234 7378
Italy	Pordenone	+39 (0) 800117511
Sweden	Stockholm	+46 (0) 20 78 77 50
UK	Slough	+44 (0) 1753 219 898

EOG 900 - 311451609

# Contents Check List

**Note:**

If you require replacements of the item listed below please contact your local Service Force Centre quoting the relevant part number.

The loose contents of this pack include:-

No. OFF	DESCRIPTION
1	Grill Pan Handle (311468100)
1	Fixing Kit
1	Grill Grid (311419801)
1	Grill Pan (311409401)
1	Trivet (Enamel) (311419701)
2	Oven Shelf
1	Oven Shelf with Baffle Plate
1	Meat Tin (311409401)

**Note :**

If you require an additional handle for your grill pan. This can be ordered from your local Service Force Centre by quoting part number 311479800/6.

This handbook was correct on the date it was printed. But this handbook will be replaced if the specification or appearance changes during production.

ELECTROLUX, 55 -77 HIGH STREET, SLOUGH,  
BERKSHIRE, SL1 1DZ  
TELEPHONE 0870 5 950950



© Electrolux Household Appliances Limited 2001

EOG900 - 311451609

 **The Electrolux Group.** *The world's No.1 choice.*

*The Electrolux Group is the world's largest producer of powered appliances for kitchen, cleaning and outdoor use. More than 55 million Electrolux Group products (such as refrigerators, cookers, washing machines, vacuum cleaners, chain saws and lawn mowers) are sold each year to a value of approx. USD 14 billion in more than 150 countries around the world.*



**This file has been downloaded from:**

[www.UsersManualGuide.com](http://www.UsersManualGuide.com)

User Manual and User Guide for many equipments like mobile phones, photo cameras, mother board, monitors, software, tv, dvd, and othes..

Manual users, user manuals, user guide manual, owners manual, instruction manual, manual owner, manual owner's, manual guide, manual operation, operating manual, user's manual, operating instructions, manual operators, manual operator, manual product, documentation manual, user maintenance, brochure, user reference, pdf manual