

# SANTO 3790-6 KG



Refrigerator/Freezer Combination

Operating Instructions

## Dear customer,

Before placing your new appliance into operation please read these operating instructions carefully. They contain important information for safe use, for installation and for care of the appliance.

Please keep these operating instructions for future reference. Pass them on to possible new owners of the appliance.



Notes which are important for your safety or for the proper functioning of the appliance are stressed with a warning triangle and/or with signal words (**Warning!**, **Caution!**, **Important!**). Please observe the following carefully.



1. This symbol and numbered instructions guide you step by step in the operation of the appliance.
2. ....



Supplementary information regarding operation and practical uses of the appliance appear after this symbol.



Tips and notes concerning economical and environmentally sound use of the appliance are marked with the cloverleaf.

Explanations of the technical terminology used in the operating instructions can be found at the end in the section "Technical Terminology".

The operating instructions contain instructions for the correction of possible malfunctions by the user in the section "What to do if ...". If these instructions should not be sufficient, please contact your local AEG Service Force Centre.

Printed on paper manufactured with environmentally sound processes.  
he who thinks ecologically acts accordingly ...

---

# Contents

<b>Important Safety Instructions</b> .....	5
<b>Environmental Information</b> .....	7
Packaging .....	7
Old Appliances .....	7
<b>Appliance Transport</b> .....	8
<b>Before Use</b> .....	9
Packaging .....	9
<b>Installation</b> .....	10
Installation Location .....	10
The refrigerator/freezer needs ventilation .....	11
Appliance Alignment .....	11
Fitting the Plinth .....	11
Electrical Connection .....	12
<b>Reversing The Door</b> .....	13
<b>Appliance Description</b> .....	15
View of Appliance .....	15
No-Frost-System .....	16
Control Panel .....	16
Freezer tray .....	16
<b>Prior to Initial Start-Up</b> .....	17
<b>Starting Up and Regulating the Temperature</b> .....	18
<b>FROSTMATIC Button</b> .....	19
<b>“Open Door” Warning</b> .....	20
<b>Temperature Warning</b> .....	20
<b>Switching the Appliance Off</b> .....	21
<b>Holiday Mode</b> .....	21
<b>Opening the Freezer Compartment Door</b> .....	21

<b>Interior Accessories</b> .....	22
Storage Shelves .....	22
Bottle Rack .....	22
FRESH Box .....	23
Variable Inner Door .....	23
Bottle Holder .....	23
<b>Proper Storage</b> .....	24
<b>Freezing</b> .....	26
<b>Frozen Storage</b> .....	27
<b>Preparation of Ice Cubes</b> .....	27
<b>Storage Goods Symbols/Freezing Calendar</b> .....	27
<b>Hints and Tips</b> .....	28
Normal Operating Sounds .....	28
Food Storage .....	28
Energy Saving Advice .....	28
<b>Maintenance and Cleaning</b> .....	29
Replacing the light bulb .....	30
<b>What to do if ...</b> .....	31
Correcting Malfunctions .....	31
<b>Regulations, Standards, Guidelines</b> .....	33
<b>Technical Terminology</b> .....	33
<b>Guarantee Conditions</b> .....	34
<b>Service &amp; Spare Parts</b> .....	35



## Important Safety Instructions

These warnings are provided in the interests of your safety. Ensure that you understand them all before installing or using this appliance. Your safety is of paramount importance. If you are unsure about any of the meanings of these warnings contact the Customer Care Department.

### Prior to Installation

- Check the refrigerator/freezer for transport damage. Under no circumstances should a damaged appliance be installed! In the event of damage, please contact your retailer.

### Installation

- This appliance is heavy. Care should be taken when moving it.
- It is dangerous to alter the specifications or attempt to modify this product in any way.
- Ensure that the appliance does not stand on the electrical supply cable. If the supply cable is damaged, it must be replaced by a cable available from your local Service Force Centre.
- Any electrical work required to install this appliance should be carried out by a qualified electrician or competent person.
- Parts which heat up should not be exposed. Whenever possible, the back of the appliance should be close to a wall, but leaving the required distance for ventilation, as stated in the installation instructions.
- The appliance should be left for 2 hours after installation before it is turned on, in order to allow the refrigerant to settle.

### Refrigerant

The refrigerant isobutane (R600a) is contained within the refrigerant circuit of the appliance, a natural gas with a high level of environmental compatibility, which is nevertheless flammable.

- During transportation and installation of the appliance, be certain that none of the components of the refrigerant circuit become damaged.
- If the refrigerant circuit should become damaged:
  - avoid open flames and sources of ignition;
  - thoroughly ventilate the room in which the appliance is situated.

### **Child Safety**

- Do not allow children to tamper with the controls or play with the product.
- Keep packaging material away from children! (There is a risk of suffocation!)

### **During Use**

- This appliance is designed for domestic use only, specifically for the storage of edible foodstuffs only. It is not intended for commercial or industrial use
- Containers with flammable gases or liquids can leak at low temperatures. Do not store any containers with flammable materials such as, spray cans, fire extinguisher refill cartridges etc in the freezer.
- Frozen food should not be refrozen once it has thawed out.
- Do not place carbonated or fizzy drinks in the freezer.
- Ice lollies can cause 'frost/freezer burns' if consumed straight from the freezer compartment.
- Do not remove items from the freezer compartment if your hands are damp/wet, as this could cause skin abrasions or frost/freezer burns.
- Bottles and cans must not be placed in the freezer. They can burst when the contents freeze.
- Manufacturers' recommended storage times should be adhered to. Refer to relevant instructions.

### **Maintenance and Cleaning**

- Before cleaning, always switch off the appliance and disconnect from the electrical supply.
- When unplugging always pull the plug from the mains socket, do not pull on the cable.

### **Servicing**

- This product should be serviced by an authorised engineer and only genuine spare parts should be used.
- Under no circumstances should you attempt to repair the appliance yourself. Repairs carried out by inexperienced persons may cause injury or serious malfunctioning.  
Contact your local AEG Service Force Centre.

---

# Environmental Information

## Packaging

All transit packaging materials are environmentally compatible and can be reused. Wood is un-treated. The plastics can be recycled and are identified as follows:

>PE< for polyethylene, e.g. the outer covering and the bags in the interior.

>PS< for polystyrene foam, e.g. the pads, which are pure hydrocarbon compounds and can be recycled.

The carton parts are made from recycled paper. Please dispose of the packaging with due care for the environment.

## Old Appliances

When disposing of your old appliance:

Make the appliance unusable by cutting off the cable and remove any door catches to ensure small children cannot be trapped inside.

Help to keep your country tidy - use an authorised disposal site.

# Appliance Transport

Two persons are required to transport the appliance. There are two recessed handles at the back of the appliance at the top for improved gripping.

1. Grip the appliance with the recessed handles positioned as in the drawing, and transport the appliance.

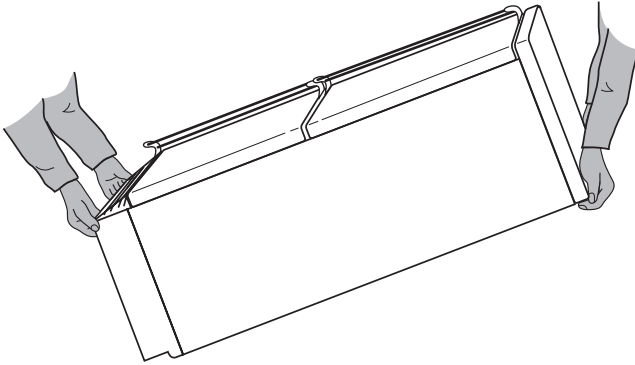



2. In order to push the appliance into its final position, press carefully at the top of the door and tip the appliance back slightly. The weight is thus transferred to the back wheels and the appliance can be easily pushed.



# Before Use

## Packaging

 1. Remove all adhesive tape and packaging from the interior of the appliance.

 Any remnants of adhesive can be removed with white spirit.

2. Remove the transport protection pieces and pull off the adhesive tape.

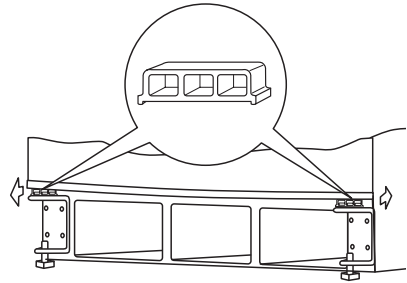

3. Remove the transport fittings from the storage shelves:  
Slide the fittings securing the shelf forward to the thicker section on the edge of the storage shelf.

4. Slide the storage shelf far enough forward so that it can be hinged downwards and the fittings can be removed from the guides.

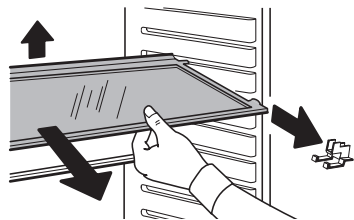
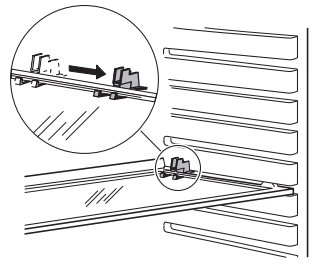

# Installation

## Installation Location

The appliance should be installed in a well ventilated, dry room.

Energy use and efficient performance of the appliance is affected by the ambient temperature.

The appliance should therefore

- not be exposed to direct sunlight;
- not be installed next to radiators, cookers or other sources of heat;
- only be installed at a location whose ambient temperature corresponds to the climate classification, for which the appliance is designed.

The climate classification can be found on the rating plate, which is located at the left on the inside of the appliance.

The following table shows which ambient temperature is correct for each climate classification:

Climate classification	for an ambient temperature of
SN	+10 to +32 °C
N	+16 to +32 °C
ST	+18 to +38 °C
T	+18 to +43 °C

If installation next to a source of heat is unavoidable, the following minimum clearances must be maintained at the sides of the appliance:

- for electric cookers 3 cm;
- for oil and coal fired ranges 30 cm.

If these clearances cannot be maintained a heat insulating pad is required between the cooker and the refrigeration appliance.

## The refrigerator/freezer needs ventilation

Air is fed under the door through the vent slots in the base and is exhausted upwards along the back wall. To ensure proper air circulation never cover or alter the vent openings.

**Important!** If the appliance is installed under a hanging cabinet, a clearance of at least 10 cm between the top of the appliance and the cabinet above it must be maintained.

Please check whether, after installing your appliance and especially after reversing the door, the door seal seals tightly. A badly fitting door seal may lead to heavy frosting and a higher power consumption (see also "What to do if ...").

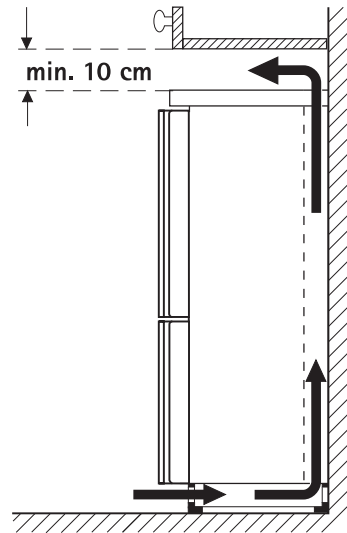

## Appliance Alignment

- 👉 1. The appliance must be level. Please compensate for unevenness in the floor by turning the two adjustable feet at the front.

## Fitting the Plinth

- 👉 1. Take the plinth cover out of the fridge compartment.
- 2. Fit the plinth cover with the freezer door open. To do this, follow the instructions that are supplied with the plinth cover.

## Electrical Connection

Any electrical work required to install this appliance should be carried out by a qualified electrician or competent person.



### WARNING – THIS APPLIANCE MUST BE EARTHED

The manufacturer declines any liability should these safety measures not be observed.

Before switching on, make sure the electricity supply voltage is the same as that indicated on the appliance rating plate. The rating plate is inside, on the left.

The appliance is supplied with a 13 amp plug fitted. In the event of having to change the fuse in the plug supplied, a 13 amp ASTA approved (BS 1362) fuse must be used.

### Important

The wires in the mains lead are coloured in accordance with the following code:

Green and Yellow	Earth
Blue	Neutral
Brown	Live

As the colours of the wires in the mains lead of this appliance may not correspond with the coloured markings identifying the terminals in your plug, proceed as follows:

1. The wire coloured green and yellow must be connected to the terminal marked with the letter "E" or by the earth symbol  $\oplus$  or coloured green and yellow.
2. The wire coloured blue must be connected to the terminal "N" or coloured black.
3. The wire coloured brown must be connected to the terminal marked "L" or coloured red.
4. Upon completion there must be not cut, or stray strands of wire present and the cord clamp must be secure over the outer sheath.

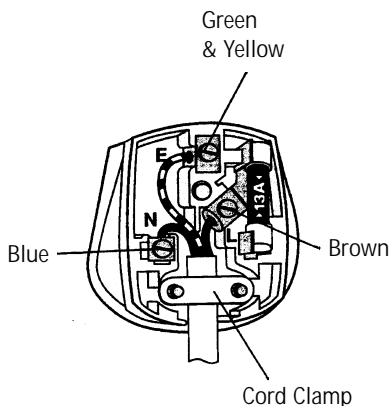

**Warning!** A cut-off plug inserted into a 13 amp socket is a serious safety (shock) hazard. Ensure that the cut-off plug is disposed of safely.

# Reversing The Door

The door hinges can be changed from right (as supplied) to left if required to suit the location where the appliance is installed.



**Warning!** Unplug from the mains, before reversing the door.

1. Open the freezer door and withdraw the plinth cover to the front. At the same time, press on the plinth cover from above. Transfer the door bearing covers on the plinth cover from left to right.

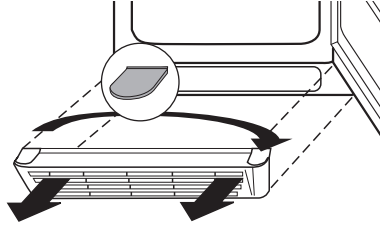

2. Unscrew the centre door bearing:

Open the fridge and freezer doors. Undo the screws far enough to be able to take the top door bearing bolt out of the freezer door. Close the freezer door. Remove the door bearing bolt from the bottom of the fridge door and close the fridge door.

**Caution!** Take care when removing the centre door bearing that the doors do not fall down.

Remove the centre door bearing; remove the doors and lay them carefully on the floor.

3. Unscrew the upper and lower door bearing bolts, transfer, and screw them onto the opposite side.
4. Remove the plastic covers for the centre door bearing and insert them in the now vacant holes on the opposite side.

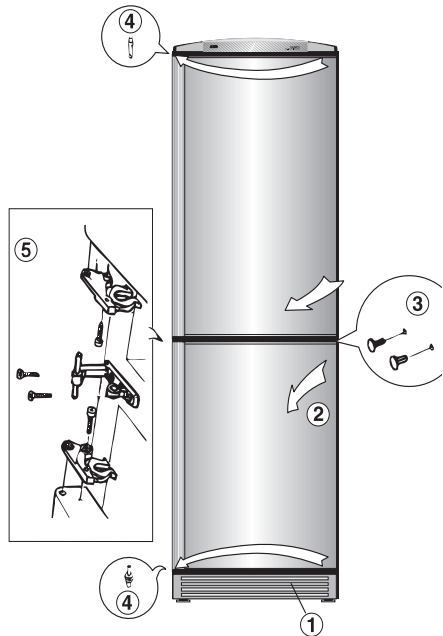

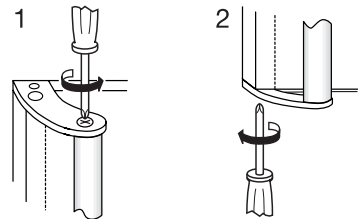

5. Transfer the self-closing system:
  - Unscrew the self-closing system on the right of the freezer door and screw it onto the opposite side of the freezer door.
  - Unscrew the self-closing system on the right of the fridge door and screw it onto the opposite side of the fridge door.
6. Fit the freezer door into the lower door bearing bolt and insert the centre door bearing above into the freezer door.
7. Insert the fridge door into the upper door bearing bolt. Pull both doors forwards until the centre door bearing can be inserted below into the fridge door.
8. Position the doors and centre door bearing against the housing and screw the centre door bearing tight with each door open.
9. Fit the plinth cover with the freezer door open. To do this insert the two lower fins of the plinth cover in the housing and press the base-mask against the housing until the upper catches of the plinth cover snap into position in the housing. To do this, press the catches downwards. After changing the door hinges, check that the magnetic seals on the doors fit perfectly against the housing and that the interior lighting goes off when the door is closed.

10. Depending on the model:
  - Model with bar handle
  - Unscrew the top handle bracket from the handle rod (1). Unscrew the bottom handle bracket from the door (2).

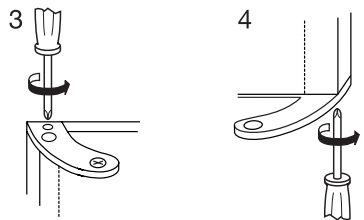

Unscrew the top handle bracket from the door (3) and screw onto the bottom right-hand side of the door (4).



-  **Caution!** Do not overtighten the screws (max. 2 Nm) as you may damage the door handles. Turn the handle bracket with the handle rod 180° and screw them to the door (5) and the fitted handle bracket (6).

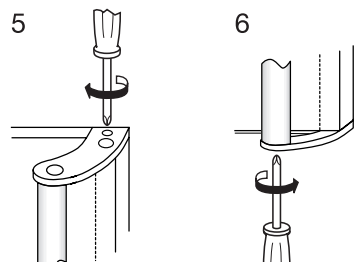

-  **Caution!** Do not overtighten the screws (max. 2 Nm) as you may damage the door handles.

# Appliance Description

## View of Appliance

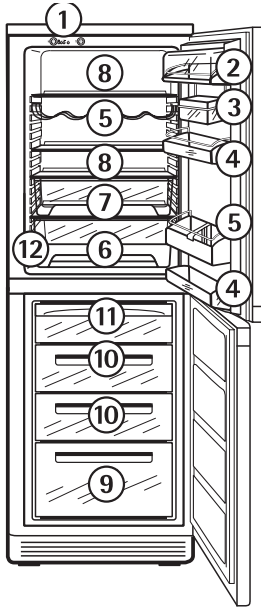

- ① Control Panel
- ② Butter and Cheese Compartment with Lid
- ③ Variable Storage Box
- ④ Door Storage Compartments
- ⑤ Bottle Compartment/Bottle Rack
- ⑥ FRESH Box
- ⑦ Fruit/Vegetable Drawer
- ⑧ Shelves
- ⑨ Freezer Drawer (Maxi Box)
- ⑩ Freezer Drawer
- ⑪ Freezer Tray
- ⑫ Rating Plate

## No-Frost-System

The **no-frost-system** enables both the freezing of fresh foods and the storage of ready frozen or cooled foods by means of cold air. A vaporiser cools the air in the interior space of the appliance, which is circulated and uniformly distributed by a ventilator. This uniformly circulating air-flow provides for a dry climate, minimal temperature fluctuations and minimal temperature differences throughout the appliance's interior space. The moisture in the air condenses as frost on the evaporator. As soon as is necessary, the evaporator defrosts fully automatically. The melted water is drained off outside to the compressor and evaporates as a result of the heat generated there. This means that the interior of the appliance and the stored chilled or frozen food-stuffs always remain free of frost and ice. Manual defrosting is not needed.

## Control Panel

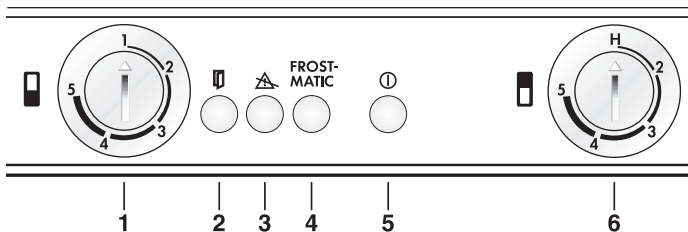

- 1 Temperature control knob for the freezer
- 2 WARNING OFF button (open door warning) (red)
- 3 WARNING OFF button (temperature warning) (red)
- 4 FROSTMATIC button (for rapid freezing in the freezer compartment) (yellow)
- 5 ON/OFF switch (green)
- 6 Temperature control knob for fridge

## Freezer tray

Berries, for example, can be pre-frozen on the freezer tray. Advantage: The berries are not squeezed and maintain their natural form. The frozen berries can then be stored in compartments or drawers packaged in individual portions.



---

## Prior to Initial Start-Up



Before connecting the appliance to the mains and putting it into operation for the first time, leave the appliance to stand for 30 minutes if it was transported upright. After transport on its side, the appliance must be left to stand for 2 hours before putting it into operation. This is necessary to allow the oil to flow back into the compressor. Otherwise the compressor may be damaged.



**1.** Please clean the appliance interior and all accessories prior to initial start-up (see section: "Maintenance and Cleaning").

# Starting Up and Regulating the Temperature

It is possible to regulate the temperature in the fridge and freezer separately. The control panel is located behind the fridge door at the top of the fridge.

-  1. Insert plug into mains socket.
2. Open the fridge door.
3. Hold the ON/OFF button pressed for three seconds. The ON/OFF button will be illuminated in green, the interior lighting will go on, and the fridge will start to work. If the temperature warning tone sounds it can be cancelled by pressing the WARNING OFF button.

## Setting the Fridge Temperature

A coin is required to turn the temperature control knob. This makes it more difficult to change the temperature setting accidentally (child safety).

**Setting "H"** = holiday switch

**Setting "2"** = warmest interior temperature

**Setting "5"** = coldest interior temperature

-  1. Using a coin, set the temperature required for the fridge by turning the temperature control knob. Select a middle position for normal operation.

The interior temperature is affected by the ambient temperature, the amount of food in the fridge, and how frequently and for how long the door is opened.

2. Close the fridge door

 As the storage temperature within the fridge is reached quickly you can store food immediately after switching on.

## Setting the Freezer Temperature

A coin is required to turn the temperature control knob. This makes it more difficult to change the temperature setting accidentally (child safety).

**Setting "1"** = warmest interior temperature

**Setting "5"** = coldest interior temperature

-  1. Using a coin, set the temperature required for the freezer by turning the temperature control knob. Select a middle position for normal operation.
2. Press the FROSTMATIC button. The FROSTMATIC button will be illuminated in yellow and the compressor will operate continuously.

3. To switch off the FROSTMATIC function, press the FROSTMATIC button again. The yellow FROSTMATIC button will go off.
4. Wait until the temperature in the freezer compartment has reached  $-18\text{ }^{\circ}\text{C}$  before storing frozen foods.

 Where food hygiene is concerned  $-18\text{ }^{\circ}\text{C}$  should be considered sufficiently cold for storing food in the freezer.

**Information:** The red warning indicator and temperature warning tone will be activated:

- when the freezer is started up (if the storage temperature has not yet been reached)
- if the temperature in the freezer compartment is too warm;
- if there is a malfunction in the appliance.

You can cancel the warning tone with the WARNING OFF button. The warning indicator and warning tone switch off automatically when the temperature in the freezer falls below  $-10\text{ }^{\circ}\text{C}$ .

Such a temperature increase is probably due to:

- frequent or extended opening of the door;
- storing large quantities of warm food;
- high ambient temperature;
- a fault in the appliance.

## FROSTMATIC Button

The FROSTMATIC function accelerates the freezing of fresh food and, at the same time, protects foodstuffs already stored from undesirable warming.

-  1. The FROSTMATIC function is switched on by pressing the FROSTMATIC button. The button is illuminated in yellow. The compressor runs continuously.
2. The FROSTMATIC function can be switched off again manually at any time by pressing the FROSTMATIC button again. The yellow illumination in the button will go off.  
If the FROSTMATIC function is not ended manually, the appliance electronics switch off the FROSTMATIC function after 36 hours. The yellow illumination in the button will go off.

## "Open Door" Warning

When the fridge or freezer doors are open the open door warning button flashes red and a warning tone is sounded.

- after approx. 1 minute if the freezer door is open
- after approx. 4 minutes if the fridge door is open

If you need more time for inserting frozen or chilled foods or moving them around you can switch off the warning tone by pressing the WARNING OFF button. The button will stop flashing and will be illuminated in red.

The warning tone and the red warning indicator switch off when the doors are closed.

## Temperature Warning

The WARNING OFF button flashes in red and a warning tone sounds as soon as the temperature in the freezer rises above  $-10\text{ }^{\circ}\text{C}$ .

-  1. You can cancel the warning tone with the WARNING OFF button. The button will stop flashing and will be illuminated in red.

 The warning tone and the red warning indicator switch off automatically when the temperature in the freezer falls below  $-10\text{ }^{\circ}\text{C}$ .

Such a temperature increase is probably due to:

- frequent or extended opening of the door;
- storing large quantities of warm food;
- high ambient temperature;
- a fault in the appliance.

**Attention!** If suspicion of partial or complete thawing exists, please check the quality of the foods to determine if they can be used.

If the temperature warning stays on for a longer period please contact AEG Service Force.

## Switching the Appliance Off

- 1. To switch off, hold down the ON/OFF button for approx. 3 seconds. The green illumination in the button will go off.

**If the appliance is not going to be used for an extended period:**

- 1. Switch off the appliance by holding down the ON/OFF button for approx. 3 seconds. The green illumination in the button will go off.
- 2. Remove the mains plug or switch off.
- 3. Clean the appliance thoroughly (see section: "Cleaning and Care").
- 4. Leave the doors open after defrosting to avoid accumulation of odours.

## Holiday Mode

In the holiday mode the temperature for the refrigerator is approximately between +10 °C and +12 °C. In the holiday mode it is therefore possible to leave the door of the empty refrigerator closed during periods of extended absence. Advantage: Unintentional closing of the door, or accidental closing of the door by persons who have access to your home during your absence, is no longer a problem. Without the holiday mode leaving the door closed would lead to the accumulation of odours and mould.

After emptying and cleaning the appliance, proceed as follows:

- 1. To switch on the holiday mode, turn the temperature control knob for the fridge to position H.

**Important!** Do not store any foodstuffs in the fridge when the holiday mode is operating. The temperature when the holiday position is selected is regulated to between approximately +10 °C and +12 °C. This is too warm for foods.

## Opening the Freezer Compartment Door

If the freezer compartment door is closed when the appliance is in operation, it is possible that it cannot be immediately opened again. A vacuum occurs in the freezer compartment which holds the door closed until pressure has been equalised. The door can be opened again after several minutes.

# Interior Accessories

## Storage Shelves

The shelf in the lowest runners above the fruit and vegetable drawer is stopped with plastic corners on the back. It must always remain in this position, so that fruit and vegetables stay fresh for longer. To remove the stops, the plastic corners must be twisted 90° forwards and to the outside.

The remaining storage shelves can be adjusted to various heights:

1. Pull the storage shelf forward until it can be tipped up or down and removed.
2. To insert at a different height use the same procedure in reverse.

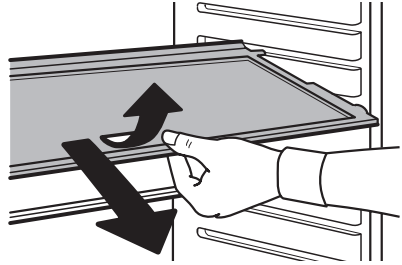

## Bottle Rack

Place bottles in the rack with the bottleneck to the front.

**Important:** Only store unopened bottles horizontally.

The bottle rack can be tilted for storing opened bottles.

1. To do this pull the bottle rack forward until it can be tilted upwards, then slide the front support into the next level up.

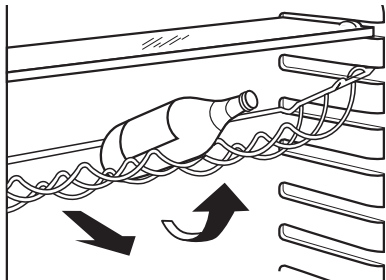
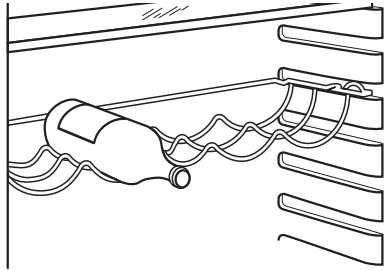

## FRESH Box

The temperature in the FRESH Box is somewhat lower than in the rest of the fridge. It is therefore especially suitable for storing meat, fish and chilled meals. The FRESH Box can be pulled out, by lifting up the front cover of the box.

## Variable Inner Door

The door compartments can be pulled up and removed, and inserted at other positions as needed.

## Bottle Holder

Some models are equipped with a bottle holder in the bottle compartment. This is used to prevent individual bottles from falling over and can be slid sideways.

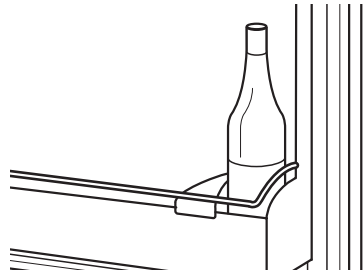

## Proper Storage

The cooling fans ensure an even temperature distribution in the fridge. Foods with different perishability can therefore be arranged on the shelves as you like, without having to take into account the different temperature zones which usually occur. The temperature on the shelf above the fruit and vegetable drawer is somewhat higher than the fridge temperature set. The example arrangement opposite shows possible ways of storing food.

**Important!** Do not place foods too closely in front of the vents at the rear of the appliance as the foods might freeze.

In order to check the temperature in the refrigerator compartment you can carry out the following test yourself:

1. Place a cup of water in the centre of the said shelf with a thermometer inside.
2. Leave the fridge door closed overnight and check the temperature first thing in the morning.
3. At this point the temperature should read no more than 5 °C; if it does, you need to adjust the temperature control knob to a colder setting.

For further information on keeping food cool and safe a guide published by the Ministry of Agriculture, Fisheries and Food is available and can be obtained free of charge by contacting:

Foodsense, London SE99 7TT. Tel: 0645 556000

**Tip:** Food stored in the refrigerator compartment should always be covered or packed so that they do not dry out, lose their flavour, or transfer their flavour to any other refrigerated food.

The following are suitable for packing:

- polyethylene bags;
- plastic containers with lids;
- special plastic covers with rubber retainers;
- aluminium foil.

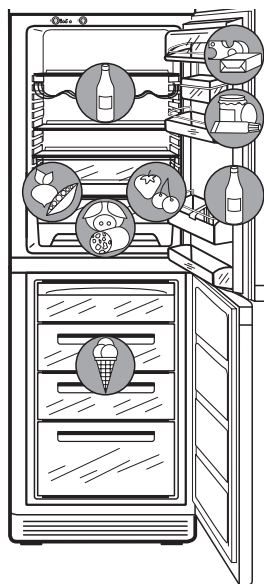



To obtain the best performance from your refrigerator/freezer:

- Do not store warm food or evaporating liquids.
- Do not store food uncovered.
- Keep the time between buying chilled food and placing it in your freezer as short as possible.
- Do not push food together too much, try to allow air to circulate around each item.

# Freezing

## Warning!

- Before foods are frozen, the actual temperature in the freezer compartment must be -18 °C or colder.
- Please observe indicated freezing capacity on the rating plate. The freezing capacity represents the maximum amount of fresh goods that can be frozen within 24 hours. If you freeze goods on several days, one after the other, freeze amounts equal to 2/3 to 3/4 of the capacity indicated on the rating plate.
- Thawed foods which have not been processed further (cooked into meals) may not under any circumstances be frozen a second time.

-  1. For freezing the maximum capacity press the FROSTMATIC button 24 hours prior to freezing, or 4 to 6 hours for smaller quantities. Yellow indicator lights up.

 The FROSTMATIC button need not be pressed for freezing of small quantities of up to 3 kg.

2. All foods must be packed air tight prior to freezing, so that they do not dry out or lose their flavour, and so that no flavour contamination of other frozen goods occurs.

**Caution!** Do not touch frozen goods with wet hands. Hands can freeze to the goods.

3. Place packaged goods in the drawers. Unfrozen goods may not come into contact with already frozen goods, otherwise the frozen goods may start to thaw.

## Tips:

- The following are suitable for the packaging of frozen goods:
  - freezer bags and polyethylene wraps;
  - plastic containers for frozen foods;
  - extra-thick aluminium foil
- The following are suitable for sealing bags and wraps: plastic clips, rubber bands or adhesive tape.
- Press air out of bags and wraps before sealing, because air encourages drying of frozen goods.
- Make flat packages, because these freeze more quickly.
- Do not fill plastic containers for frozen foods to the brim with liquid or paste-like goods, because liquids expand during freezing.

# Frozen Storage

**Warning!** Before initial loading of the freezer compartment with previously frozen goods, the required storage temperature of  $-18\text{ }^{\circ}\text{C}$  must be reached.

- Load freezer only with packaged frozen goods, so that they do not dry out or lose their flavour, and so that no flavour contamination of other frozen goods can occur.
- Please observe maximum storage times and expiry dates of frozen goods.



When possible store frozen goods separately according to type in drawers.

## Preparation of Ice Cubes

1. Fill ice cube tray 3/4 full with cold water and place in the freezer tray or a drawer and allow to freeze.
2. To remove the finished ice cubes twist the ice cube tray or hold under running water for a short time.

**Warning!** Do not, under any circumstances, free an ice tray which is frozen to the appliance with pointed or sharp edged objects. Use a spoon-handle or similar object.

## Storage Goods Symbols/Freezing Calendar

- The symbols on the drawers show different types of frozen goods.



- The numbers indicate storage times in months for the appropriate types of frozen goods. Whether the upper or lower value of the indicated storage time is valid depends on the quality of the foods and pre-treating before freezing. The lower value applies to foods with high fat content.

# Hints and Tips

## Normal Operating Sounds

- You may hear faint gurgling or bubbling sounds when the refrigerant is pumped through the coils or tubing at the rear, to the cooling plate/evaporator.
- When the compressor is on, the refrigerant is being pumped round and you will hear a whirring sound or pulsating noise from the compressor.
- A thermostat controls the compressor and you will hear a faint click when the thermostat cuts in and out.

## Food Storage

To obtain the best performance from your refrigerator/freezer:

- Do not store warm food or evaporating liquids.
- Do not store food uncovered.
- Keep the time between buying chilled food and placing it in your freezer as short as possible.
- Do not push food together too much, try to allow air to circulate around each item.



## Energy Saving Advice

- Do not install the appliance close to sources of heat, such as a cooker, dishwasher or radiator.
- Locate the appliance in a cool well ventilated room and make sure that the air openings of the appliance are not obstructed.
- Always leave warm food to cool down to room temperature before placing in the freezer.
- Try to avoid keeping the door open for long periods or opening the door too frequently as warm air will enter the cabinet and cause the compressor to switch on unnecessarily often.
- Ensure there are no obstructions preventing the door from closing properly.

# Maintenance and Cleaning

Before any maintenance or cleaning work is carried out **DISCONNECT** the appliance from the **ELECTRICITY** supply.



## Warning!

- Do not use detergents, abrasive powders, highly perfumed cleaning products, wax polishes or cleaning products containing bleach or alcohol.
- Never clean the appliance with a steam cleaner. Moisture could accumulate in electrical components, danger of electrical shock! Hot vapours can lead to the damage of plastic parts.
- The appliance must be dry before it is placed back into service.

## Attention!

- Ethereal oils and organic solvents can attack plastic parts, e. g.
  - lemon juice or the juice from orange peels;
  - butyric acid;
  - cleansers which contain acetic acid.Do not allow such substances to come into contact with appliance parts.
- Do not use any abrasive cleansers.



If the refrigerator only is to be cleaned, press the FROSTMATIC button several hours in advance, in order to build up sufficient chill reserve in the freezer compartment for the interruption in service. Do not open the freezer compartment door.

-  1. About 12 hours prior to cleaning push the FROSTMATIC button, in order to build up sufficient chill reserve for the interruption in operation.

**Caution!** Do not touch frozen goods with wet hands. Hands can freeze to the goods.

2. Remove frozen goods, pack them in several layers of newspaper, cover them and store them in a cool place.
3. Switch off refrigerator and freezer and remove plug from the mains, or switch off or turn out the circuit breaker or the fuse.
4. Clean the inside and accessories with warm water and bicarbonate of soda (5 ml to 0.5 litre of water).
5. Rinse and dry thoroughly.
6. Regularly check the door seals and wipe clean to ensure they are clean and free from debris.



Accumulation of dust at the condenser increases energy consumption. For this reason carefully clean the condenser beneath the appliance once a year with a soft brush or a vacuum cleaner.

7. After everything is dry place appliance back into service.

## Replacing the light bulb



**Warning!** Danger of electrical shock! Before replacing the light bulb switch off the appliance and remove the mains plug.

Light bulb specifications:

1x Halogen 220-240 V, max. 25 W, socket: E 14 (Osram Halolux T; clear, available from your local Service Force Centre)



1. To switch off the appliance press the ON/OFF button for 3 seconds. The green illumination will go off.
2. Unplug from the mains.
3. To change the light bulb, open the plastic cover by pressing the fastening upwards, then fold downwards.
4. Replace faulty light bulb.
5. Fold up the light bulb cover and let it click into place.

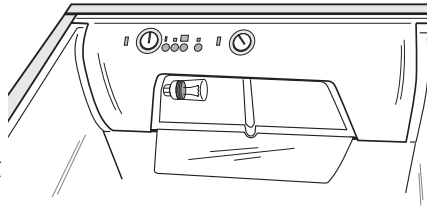

# What to do if ...

## Correcting Malfunctions

A malfunction may be caused by only a minor fault that you can rectify yourself using the following instructions. Do not perform any other work on the appliance if the following information does not provide assistance in your specific case.



**Warning!** Repairs to refrigerators/freezers may only be performed by qualified service engineers. Improper repairs can give rise to significant hazards for the user. If your appliance needs repairing, please contact your specialist dealer or our Customer Service.

Symptom	Possible Cause	Solution
No power to the appliance.	Appliance is not switched on.	Switch on the appliance.
	Mains plug is not plugged in or is loose.	Insert mains plug.
	Fuse has blown or is defective.	Check fuse, replace if necessary.
	Mains socket is defective.	Mains malfunctions are to be corrected by an electrician.
Appliance cools too much.	Temperature is set too cold.	Turn the temperature control knob to a warmer setting temporarily.
The food is too warm.	Temperature is not properly adjusted.	Please look in the "Temperature Adjustment" section.
	Door was open for an extended period.	Open the door only as long as necessary.
	A large quantity of warm food was placed in the appliance within the last 24 hours.	Press the FROSTMATIC button. Turn the temperature control knob to a colder setting temporarily.
	The appliance is near a heat source.	Please look in the "Installation" section.

Symptom	Possible Cause	Solution
The red door warning indicator is flashing; the warning tone is sounding	The freezer door has been open for longer than 1 minute and/or the fridge door has been open for longer than 4 minutes.	Switch off the warning tone using the WARNING OFF button. Do not leave the door open for longer than is necessary.
The red temperature warning indicator is flashing; the warning tone is sounding	Temperature warning	Please refer to "Temperature Warning" section.
All the lamps are flashing and a warning tone is sounding	A fault in the appliance	Please contact AEG Service Force. Do not open the appliance doors again.
Interior illumination does not function.	Light bulb is defective. Important: The interior lighting switches off automatically after 20 minutes.	Please refer to "Replacing the Light Bulb" section.
Water in the vegetable drawer	Wet vegetables have been stored	Clean drawer and ensure that vegetables are dry before storing.
The compressor does not start immediately after changing the temperature setting.	This is normal, no error has occurred.	The compressor starts after a period of time.
Noise	Appliance is not level.	Readjust the front levelling feet. Refer to Normal Operating Sounds

If after the above checks there is still a fault, call your local AEG Service Force Centre.

In-guarantee customers should ensure that the above checks have been made as the engineer will make a charge if the fault is not a mechanical or electrical breakdown.

Please note that proof of purchase is required for in-guarantee service calls.



## Regulations, Standards, Guidelines

This appliance was designed for household use and was manufactured in accordance with the appropriate standards. The necessary measures in accordance with appliance safety legislation regulations (GSG), accident prevention regulations for refrigeration appliances (VBG 20) and the regulations of the German Society of Electrical Engineers (VDE) were observed in the manufacture of this appliance. The refrigerant circuit has been checked for leaks.

- CE** This appliance is in accordance with the following EU guidelines:
- 73/23/EEG dated 19 February 1973 - low voltage guidelines.
  - 89/336/EEG dated 3 May 1989  
(including guideline change notice 92/31/EEG) - EMV guideline

## Technical Terminology

### • Refrigerant

Liquids that can be used to generate a cooling effect are known as refrigerants. They have a relatively low boiling-point, indeed so low, that the warmth from the food stored in the fridge or freezer can cause the refrigerant to boil and vaporise.

### • Refrigerant Circuit

Closed circulation system that contains the refrigerant. The refrigerant circuit comprises primarily of an evaporator, a compressor, a condenser and pipe work.

### • Evaporator

The refrigerant is evaporated in the evaporator. Similar to all other liquids, refrigerant requires heat to evaporate. This heat is removed from the interior of the appliance, as a result the interior is cooled. The evaporator is therefore located inside the appliance or placed in foam immediately behind the inner wall and thus not visible.

### • Compressor

The compressor looks like a small drum. It is driven by a built-in electric motor and is mounted on the base of the appliance at the rear. The task of the compressor is to draw in vaporised refrigerant from the evaporator, to compress it, and to pass it on to the condenser.

### • Condenser

The condenser normally has the form of a grid. The refrigerant compressed in the compressor is liquefied in the condenser. During this process, heat is released to the surrounding air at the surface of the condenser. The condenser is mounted on the base of the appliance.

# Guarantee Conditions

AEG offer the following guarantee to the first purchaser of this appliance.

1. The guarantee is valid for 12 months commencing when the appliance is handed over to the first retail purchaser, which must be verified by purchase invoice or similar documentation.

The guarantee does not cover commercial use.

2. The guarantee covers all parts or components which fail due to faulty workmanship or faulty materials. The guarantee does not cover appliances where defects or poor performance are due to misuse, accidental damage, neglect, faulty installation, unauthorised modification or attempted repair, commercial use or failure to observe requirements and recommendations set out in the instruction book.

This guarantee does not cover such parts as light bulbs, removable glassware or plastic, dust bags or filters.

3. Should guarantee repairs be necessary the purchaser must inform the nearest customer service office (manufacturer's service or authorised agent). AEG reserves the right to stipulate the place of the repair (i. e. the customer's home, place of installation or AEG workshop).
4. The guarantee or free replacement includes both labour and materials.
5. Repairs carried out under guarantee do not extend the guarantee period for the appliance. Parts removed during guarantee repairs become the property of AEG.
6. The purchaser's statutory rights are not affected by this guarantee.

## European Guarantee

If you should move to another country within Europe then your guarantee moves with you to your new home subject to the following qualifications:

- The guarantee starts from the date you first purchased your product.
- The guarantee is for the same period and to the same extent for labour and parts as exist in the new country of use for this brand or range of products.
- This guarantee relates to you and cannot be transferred to another user.
- Your new home is within the European Community (EC) or European Free Trade Area.
- The product is installed and used in accordance with our instructions and is only used domestically, i. e. a normal household.
- The product is installed taking into account regulations in your new country.

Before you move please contact your nearest Customer Care Centre, listed below, to give them details of your new home. They will then ensure that the local Service Organisation is aware of your move and able to look after you and your appliances.

France	Senlis	+33 (0) 44 62 29 29
Germany	Nürnberg	+49 (0) 800 234 7378
Italy	Pordenone	+39 (0) 800 117511
Sweden	Stockholm	+46 (0) 8 672 5360
UK	Slough	+44 (0) 1753 219899

# Service & Spare Parts

In the event of your appliance requiring service, or if you wish to purchase spare parts, please contact Service Force by telephoning:

**08705 929 929**

Your telephone call will be automatically routed to the Service Force Centre covering your post code area.

For the address of your local Service Force Centre and further information about Service Force, please visit the website at [www.serviceforce.co.uk](http://www.serviceforce.co.uk)

Before calling out an engineer, please ensure you have read the details under the heading „What to do if....“

When you contact the Service Force Centre you will need to give the following details:

1. Your name, address and post code.
2. Your telephone number
3. Clear and concise details of the fault.
4. The model and serial number of the appliance (found on the rating plate)

• Model Name



• Model Number (PNC)



• Serial Number (S-No.)



5. The purchase date

Please note that a valid purchase receipt or guarantee documentation is required for in-guarantee service calls.

## Customer Care

For general enquiries concerning your AEG appliance or for further information on AEG products please contact our Customer Care Department by letter or telephone at the address below or visit our website at [www.aeg.co.uk](http://www.aeg.co.uk).

Customer Care Department

AEG Domestic Appliances

55-77 High Street

Slough

Berkshire, SL1 1DZ

Tel. 08705 350350 (\*)

(\*) Calls may be recorded for training purposes

AEG Hausgeräte GmbH  
Postfach 1036  
D-90327 Nürnberg

<http://www.aeg.hausgeraete.de>

© Copyright by AEG

214.3674.70 – 01 - 0502

Subject to change without notice

**This file has been downloaded from:**

[www.UsersManualGuide.com](http://www.UsersManualGuide.com)

User Manual and User Guide for many equipments like mobile phones, photo cameras, mother board, monitors, software, tv, dvd, and othes..

Manual users, user manuals, user guide manual, owners manual, instruction manual, manual owner, manual owner's, manual guide, manual operation, operating manual, user's manual, operating instructions, manual operators, manual operator, manual product, documentation manual, user maintenance, brochure, user reference, pdf manual