

**ZANUSSI**



ELECTRIC

DOUBLE OVEN

AND GRILL

ZCE 5000 / ZCE 5001

INSTRUCTION BOOKLET

# IMPORTANT SAFETY INFORMATION

These warnings are provided in the interests of your safety. Ensure that you understand them all before installing or using the appliance. Your safety is of paramount importance. If you are unsure about any of the meanings of these warnings contact the Customer Care Department.

## INSTALLATION

The appliance **must** be installed according to the instructions supplied. The installation work must be undertaken by a qualified electrician/competent person. The appliance must be installed in an adequately ventilated room.

If the appliance is to be placed on a base, measures must be taken to prevent the appliance slipping from the base.

This appliance is heavy and care must be taken when moving it.

Warning: **Do not** attempt to lift or move this appliance by the handles.

All packaging, both inside and outside the appliance must be removed before the appliance is used.

It is dangerous to alter the specifications or modify the appliance in any way.

After installation please dispose of the packaging with due regard for safety and the environment.

Your local authority can arrange this.

## CHILD SAFETY

**Do not** allow young children to play with any part of the packaging.

This appliance is designed to be operated by adults. Young children must **not** be allowed to tamper with the controls or play near or with the appliance.

**CAUTION: Accessible parts may be hot when the grill is in use. Young children should be kept away.**

## DURING USE

This appliance is not intended to be operated by means of an external timer or separate remote control system. This appliance has been designed for domestic use to cook edible foodstuffs only, and must **not** be used for any other purposes.

Take great care when heating fats and oils as they will ignite if they become too **hot**.

Never place plastic or any other material which may melt in or on the oven.

**Always** stand back from the appliance when opening the doors to allow any build up of steam or heat to release.

Always use oven gloves to remove and place food in the oven.

Ensure that all vents are left unobstructed to ensure ventilation of the oven cavity.

**Ensure** cooking utensils are large enough to contain foods to prevent spillage and boil over.

During use the appliance becomes hot. Care should be taken to avoid touching heating elements inside the oven.

**Do not** leave the grill pan in position when grilling as it will become hot.

Always use oven gloves to remove and replace the grill pan handle when it is in the withdrawn or partially withdrawn position.

Always support the grill pan when it is in the withdrawn or partially withdrawn position.

The handles of saucepans, which are smaller than the heated area on the hob, will become hot. **Ensure** your hand is protected before handling the pan.

**Do not** leave the hotplates switched ON for long periods when not covered by a saucepan. The controls and cabinets may overheat.

**Do not** use the appliance if the ceramic glass is damaged. If a fault or crack becomes visible, disconnect the appliance immediately from the electricity supply and contact your local service force centre.

**Do not** place foil or plastic containers on ceramic glass.

**Ensure** the anti-tilt shelves are put in correctly.

**Never** line any part of the appliance with foil. **Do not** allow heatproof cooking material, e.g. roasting bags, to come into contact with oven elements.

**Never leave the appliance unattended when the oven door is open.**

**Do not** place sealed cans or aerosols inside the oven. They may explode if they are heated.

Ensure that all control knobs are in the OFF position when not in use.

**Do not** stand on the appliance or on the open doors.

**Do not** hang towels, dishcloths or clothes from the appliance or its handles. They are a safety hazard.

**Do not** use this appliance if it is in contact with water. **Never** operate it with wet hands.

## CLEANING AND MAINTENANCE

**For hygiene and safety reasons this appliance should be kept clean at all times. A build-up of fats or other foodstuffs could result in a fire especially in the grill pan.**

**Do not** leave cookware containing foodstuffs, e.g. fat or oil in the appliance in case it is inadvertently switched on.

Extreme care must be taken when using a ceramic hob scraper.

Always allow the appliance to cool down before switching off at the wall prior to carrying out any cleaning / maintenance work.

Only clean this appliance in accordance with the instructions given in this book.

## SERVICE

Repairs should not be carried out by inexperienced persons as this may cause injury or serious malfunction. This appliance should be serviced by an authorised Service Engineer and only genuine approved spare parts should be used.

## AT THE END OF THE APPLIANCE'S LIFE

When the time comes to dispose of your appliance please contact your local authority. They can arrange to dispose of the appliance in a safe and controlled manner.

# CONTENTS

## FOR THE USER

<b>Important Safety Information</b>	2
<b>Description of the Appliance</b>	4
<b>Getting to Know Your Appliance</b>	5
The Control Panel	5
Before Using the Appliance	6
Rating Plate	6
Preparing to Use your Appliance	6
The Cooling Fan for the Controls	6
Control Panel Indicator Neon(s)	6
Condensation and Steam	6
Cookware	6
Grill and Oven Furniture	6
Electronic Minute Minder	7
<b>The Ceramic Hob</b>	10
Using the Hob	10
Recommended Saucepans	10
Hints and Tips	11
<b>The Grill</b>	12
Using the Grill	12
Things to Note	12
The Grill Pan and Handle	12
Hints and Tips	13
Grilling Chart	13
<b>The Top Oven</b>	14
Using the Top Oven	14
Things to Note	14
To Fit the Top Oven Shelves	14
Hints and Tips	15
<b>The Main Fan Oven</b>	16
Using the Fan Oven	16
Things to Note	16
To Fit the Fan Oven Shelves	16
Hints and Tips	17
<b>Oven Cooking Chart</b>	18
<b>Roasting Chart</b>	19

<b>Defrost Feature</b>	20
Using Defrost Feature	20
Things to Note	20
Hints and Tips	20

<b>Care and Cleaning</b>	21
Cleaning Materials	21
Cleaning the Outside of the Appliance	21
Cleaning the Control Knobs and Handles	21
Cleaning the Ceramic Hob	21
Hints and Tips	23
Cleaning the Grill and Oven Furniture	23
Cleaning Inside the Grill and Oven Compartments	24
Hints and tips	24
Cleaning the Door Glass	24
Cleaning Between the Outer and Inner Door Glass	25
To Clean the Inner Glass Door	25

<b>Something Not Working?</b>	26
<b>Service and Spare Parts</b>	27
<b>Guarantee Conditions</b>	28

## FOR THE INSTALLER

<b>Technical Details</b>	29
<b>Installation Instructions</b>	30
Notes	31

To help you the following symbols will be found in the text.



Safety Instructions.

**Please read the instruction book carefully before use and retain for future reference.**

# DESCRIPTION OF THE APPLIANCE

## SLIP-IN ELECTRIC DOUBLE OVEN

Electronic Timer

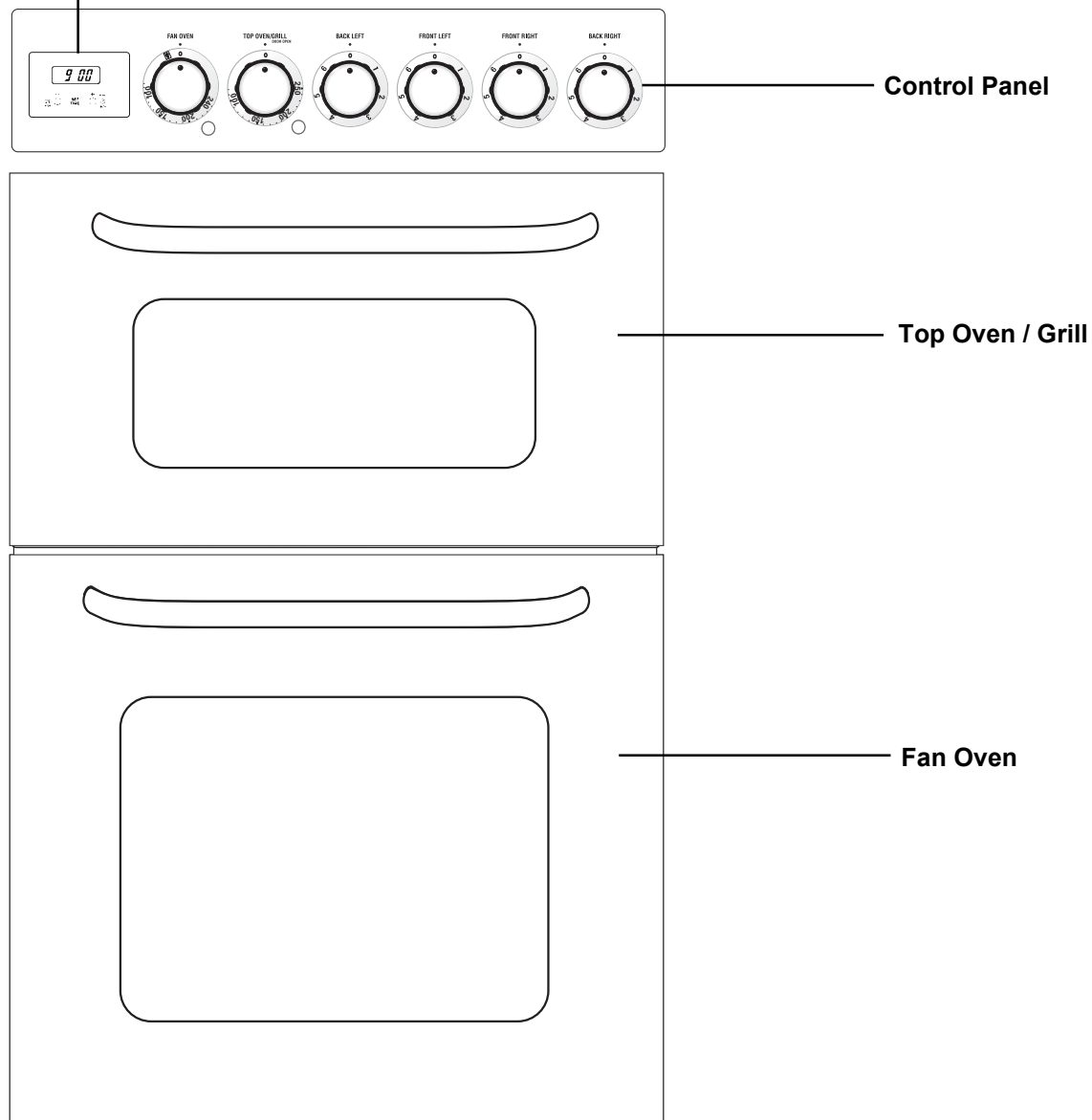

# GETTING TO KNOW YOUR APPLIANCE

## THE CONTROL PANEL

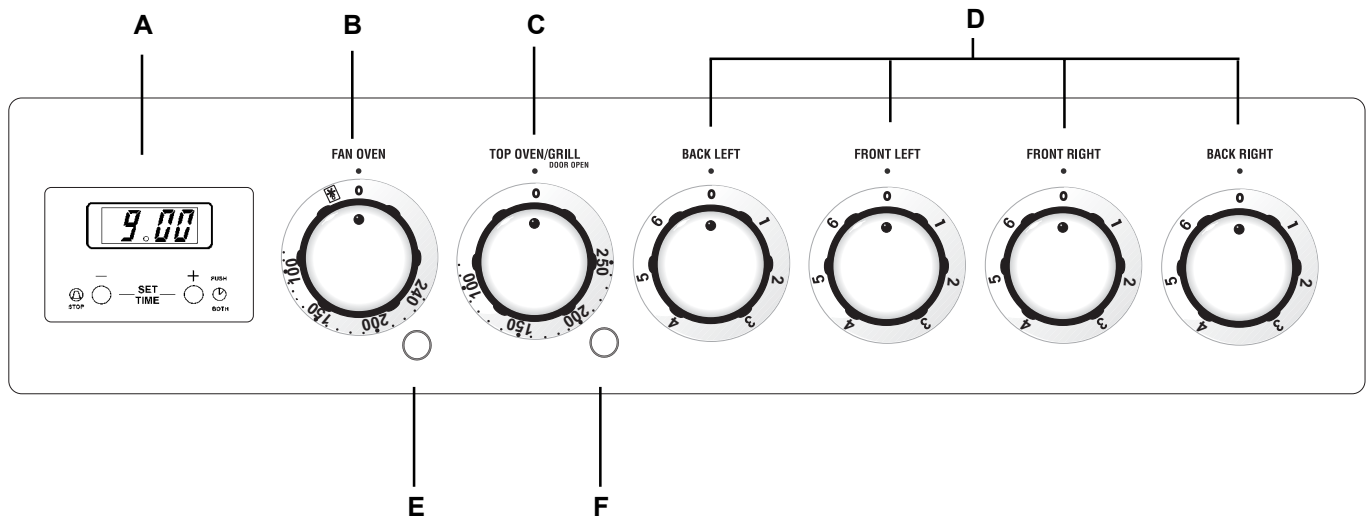

## FEATURES

- A - Electronic Minute Minder
- B - Fan Oven Temperature Control
- C - Top Oven/Grill Temperature Control
- D - Hotplate Controls
- E - Fan Oven Indicator Neon
- F - Top Oven/Grill Indicator Neon

# BEFORE USING THE APPLIANCE

## RATING PLATE

This is situated on the lower front frame of the appliance and can be seen upon opening the door. Alternatively the rating plate may also be found on the back or top of some models (where applicable).

The appliance must be protected by a suitably rated fuse or circuit breaker. The rating of the appliance is given on the rating plate.

**Do not remove the rating plate from the appliance as this may invalidate the guarantee.**

## PREPARING TO USE YOUR APPLIANCE

Wipe over the base of the oven(s) with a soft cloth and hot soapy water and wash the furniture before use. We suggest that you run the oven elements for 10 – 15 minutes at 220°C to burn off any residue from their surfaces. The procedure should be repeated with the grill for approximately 5 – 10 minutes. During this period an odour may be emitted, it is therefore advisable to open a window for ventilation.

## THE COOLING FAN FOR THE CONTROLS

The cooling fan will always come on when the grill and the top oven are switched on. If they are only used for a short period of time the fan will switch off when the controls are turned off. If the grill or the top oven are used for a longer period of time the fan will run on depending on the temperature, and may turn on and off until the appliance has cooled.

In the case of the main oven the cooling fan may not switch on except when used for a longer period of time. The cooling fan may run on, and turn on and off after the control knobs have been switched off, until the appliance has cooled. **Do not** switch the appliance off at its power point until the fan has cooled the appliance down.



**Always allow the cooling fan to cool the appliance down before switching off at the wall prior to carrying out any cleaning or maintenance work.**

## CONTROL PANEL INDICATOR NEON(S)

The indicator neon will operate when the grill (where applicable) or oven(s) is switched on. The indicator neon will glow. It may turn on and off during use to show that the setting is being maintained. If the neon does not operate as the instructions indicate the controls have been incorrectly set. Return all controls to zero and reset following the instructions for the required setting.

## CONDENSATION AND STEAM

When food is heated it produces steam similar to a boiling kettle. The vents allow some of this steam to escape. However, always stand back from the appliance when opening the door(s) to allow any build up of steam or heat to release.

If the steam comes into contact with a cool surface on the outside of the appliance, e.g. a trim, it will condense and produce water droplets. This is quite normal and is not caused by a fault on the appliance. To prevent discolouration, regularly wipe away condensation and also soilage from surfaces. For your safety wall coverings at the rear of the appliance should be securely fixed to the wall.

## COOKWARE

Baking trays, dishes etc., should not be placed directly against the grid covering the fan at the back of the oven.

**Do not** use baking trays larger than 30cm x 35cm (12" x 14") as they will restrict the circulation of heat and may affect performance.

## GRILL AND OVEN FURNITURE

The following items of grill/oven furniture have been supplied with the appliance:

1 grill pan

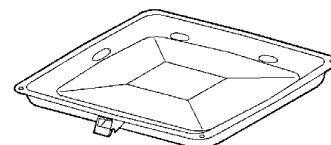

1 grill pan handle

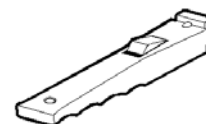

1 grill pan grid

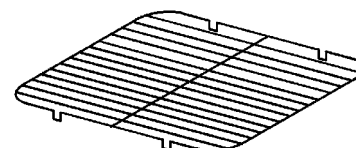

1 straight shelf  
(for grilling only)

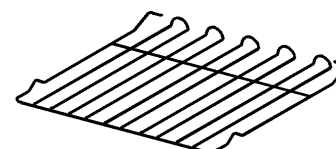

2 straight shelves  
(for fan oven cooking)

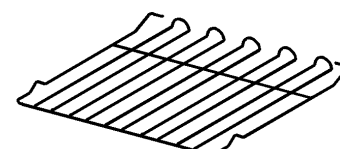

# ELECTRONIC MINUTE MINDER

## KEY

- 1 = (-) DECREASE CONTROL & MINUTE MINDER
- 2 = (+) INCREASE CONTROL
- (☺) COOKPOT SYMBOL

The electronic minute minder can indicate the time of day, operate as a minute minder and it can be used to time and switch off the main oven.

Please note that this is a 24 hour clock, for example 2.00pm is shown as 14.00.

In the following pages we explain how to use the minute minder and set the time of day. Read through them until you are familiar with the procedure.

## 1. HOW TO SET THE TIME OF DAY

When the electricity supply is first switched ON, the display will flash 0.00. See Fig.1.

Press buttons (1) and (2) together. Release buttons, 0.00 will appear in the display as Fig. 2. **Within 5 seconds** press button (2), 12.00 will show in the display as Fig. 3.

**Within 5 seconds** press and hold either button (1) to decrease or button (2) to increase the time until the correct time of day on the 24 hour clock is reached, e.g. 14.30. See Fig. 4.

**Note: The increase and decrease control buttons operate slowly at first, and then more rapidly. They should be pressed separately.**

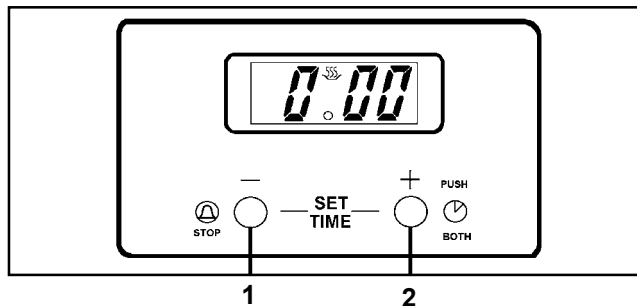

Fig.1

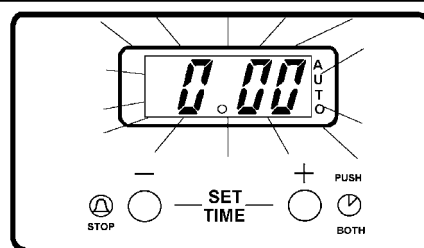

Fig.2

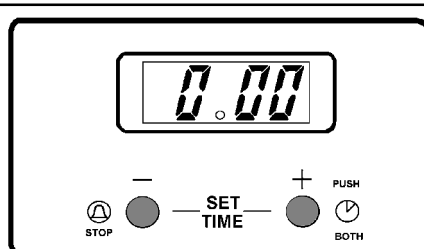

Fig.3

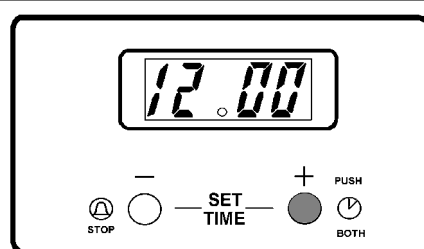
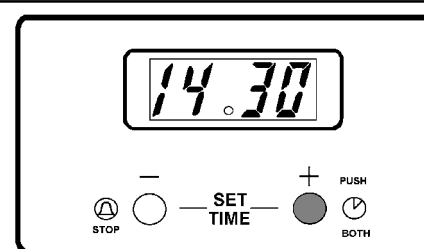

Fig.4



## 2. HOW TO SET THE MINUTE MINDER

### IMPORTANT

The minute minder can be used to time a set cooking period. At the end of the cook time the minute minder will automatically switch off the main oven if in use.

The minute minder gives an audible reminder at the end of any period of cooking up to 23 hours and 59 minutes.

To set press button (1) and the display will read 0.00, see Fig. 5.

Release button (1) and press and hold button (2). The display will count up in one minute intervals until the interval to be timed is reached e.g. 30 minutes, see Fig. 6. If necessary press and hold button (1) to achieve the correct time interval.

The minute minder will begin to count down once set. The time of day will show in the display. To show the remainder of the cook time. Press button (1).

At the end of the timed period the minute minder will click, switching the main oven OFF if in use.

An audible signal will sound for up to 2 minutes. The Auto symbol will flash and the cookpot symbol will go out. The time of day will show in the display. See Fig. 7.

To stop the sound press button (1). The display will stop flashing and show the time of day, e.g. 15.00. To return the timer to manual press button (1) again. See Fig. 8. If using the main oven it will come on again once button (1) has been depressed. When cooking is complete remove food and turn OFF oven temperature control.

### 3. TO CANCEL THE MINUTE MINDER

If you change your mind and want to cancel the minute minder. Press and release button (1). Press and hold button (1) and the display will count down in one minute intervals to 0.00. See Fig. 9. Release button (1).

After a few seconds the time of day will show in the display. See Fig. 10.

If the main oven is in use this will switch OFF after a few seconds.

To reset, press buttons (1) and (2) together. See Fig. 11.

### 4. THINGS TO NOTE

1. The time of day must be set before the main oven will operate. There will be a few seconds delay before the oven switches on.
2. The minute minder function controls the main oven and will switch the oven OFF at the end of a timed period. This function is useful if you want to begin cooking now and have the oven switch OFF automatically.
3. If you have used the minute minder to time food cooking in the main oven you will need to reset the timer by pushing button (1) before the oven can operate again.

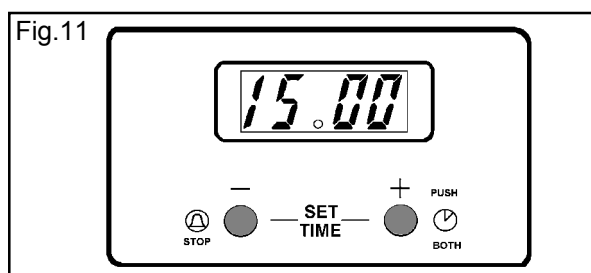
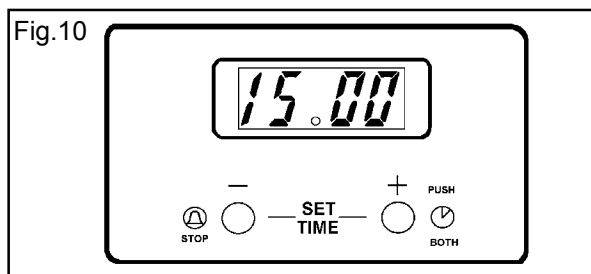
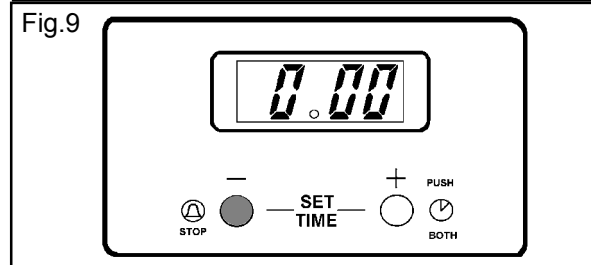
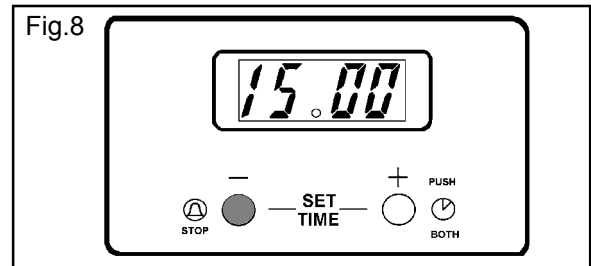
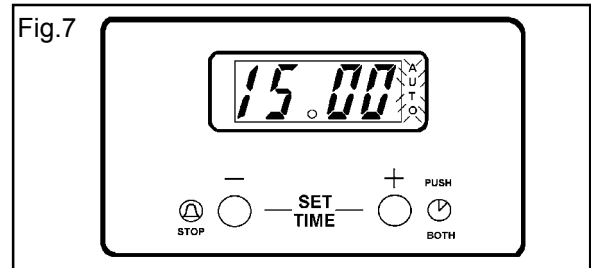
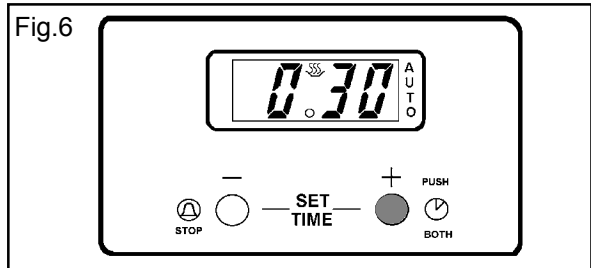
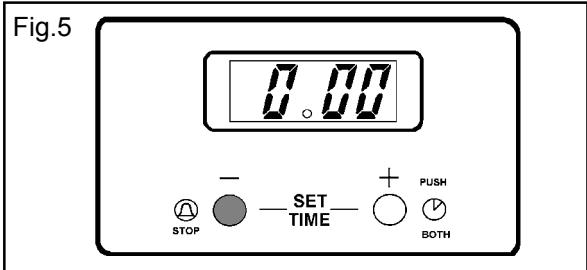



## 5. LOCK FEATURE - MAIN OVEN ONLY

Please read the following information with care.

### TO LOCK THE OVEN USING THE TIMER

Press and hold Buttons (1) and (2) on your timer for 3 - 8 seconds. See Fig. 12.

'ON' will appear in the display. See Fig. 13.

Press Button (2) to change the display to 'Of'.

The key symbol (  ) appears in the display.

The oven will now not operate.

After a few seconds the time of day will show in the display.

Wait 3 seconds before selecting another function.

### TO UNLOCK THE OVEN

Press and hold Buttons (1) and (2) for 3 - 8 seconds.

'Of' will appear in the display. See Fig. 14.

Press Button (2) to change the display to 'On'.

The key symbol (  ) will go out.

After a few seconds the time of day will show in the display.

The oven can now be operated normally.

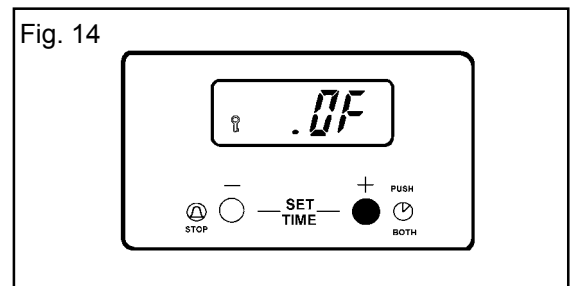
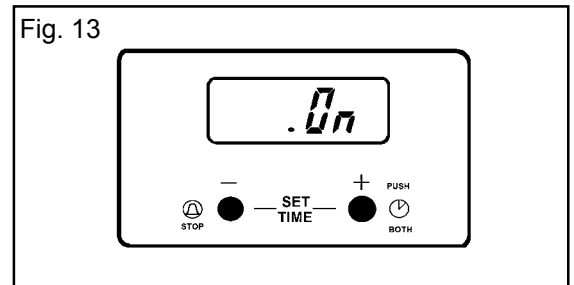
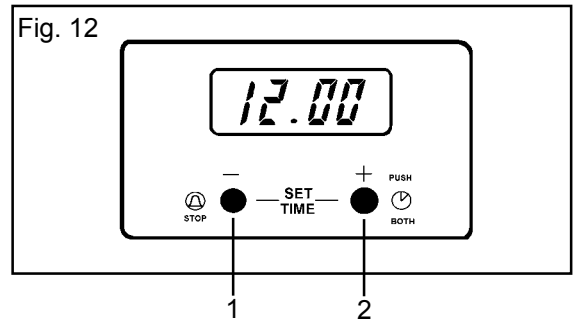

# THE CERAMIC HOB



Do not use the appliance if the ceramic glass is damaged. If a fault or crack becomes visible during cooking, disconnect the appliance immediately from the electricity supply and contact your local Service Force Centre.

## USING THE HOB

- Turn the control knobs in either direction to vary the heat setting.
- The highest number represents the hottest setting and the lowest number represents the coolest setting.

## RECOMMENDED SAUCEPANS

Only saucepans with flat bases and close fitting lids are recommended. The saucepan base should be approximately the same size as the cooking area. Ensure that new saucepans are well scrubbed to remove edges and take off any deposits left from manufacture.

Traditional round bottomed Woks **must not be** used even with a stand. Woks with flat-bottomed bases are available and do comply with the above recommendations.

### NOTE:

Occasionally the heated areas may be seen to switch ON and OFF when higher heat settings are being used. This is due to a safety device which prevents the glass from overheating.

Some switching ON and OFF when cooking at high temperatures, e.g. deep fat frying is quite normal, causes no damage to the hob and little delay in cooking times.

Excessive switching may however be caused by the use of an unsuitable saucepan or a saucepan which is smaller than the heated area. If excessive switching occurs, discontinue use of the saucepan.

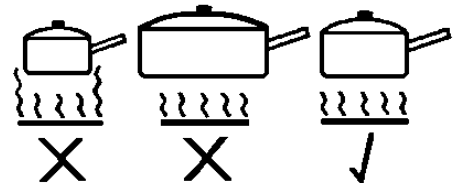
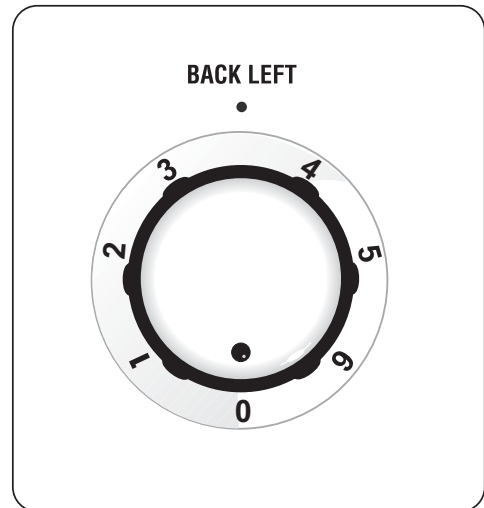

## HINTS AND TIPS

- Lift, rather than slide saucepans on and off the hob. This will reduce the risk of scratches and metal marks from saucepans with aluminium bases. Metal marks can be easily cleaned off providing they are not allowed to burn on.
- Follow any guidelines provided by the saucepan manufacturer, particularly those relating to recommended heat settings.
- Avoid using thin, badly dented or distorted saucepans. Those with uneven bases should not be used.
- Never leave the hotplates ON when not covered with a saucepan.
- Ensure that the hob and saucepans are clean and dry before the start of cooking.
- Follow the cleaning instructions very closely to keep the hob looking like new.
- **If spillage occurs with sugar solutions, e.g. jams and syrups, it must be wiped from the hob before it sets and becomes hard otherwise damage to the hob will occur.**

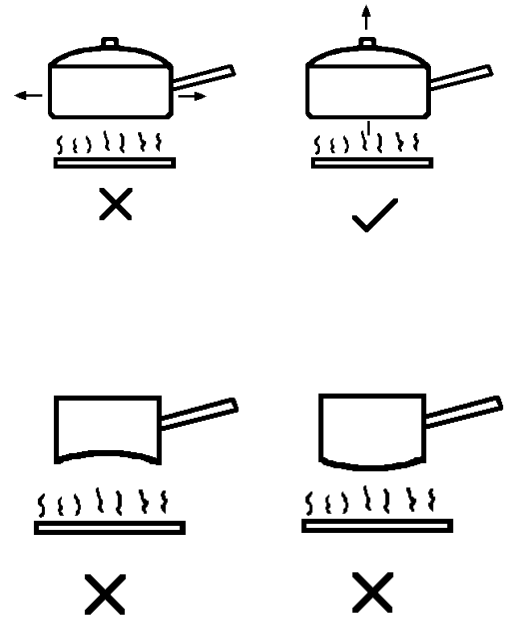

# THE GRILL



**WARNING – Accessible parts may become hot when the grill is in use. Keep children away.**

## USING THE GRILL

- Open the grill door and turn the Top Oven/Grill control to the required setting.
- The indicator neon will glow. It may turn ON and OFF during use to show that the setting is being maintained.
- At lower settings the grill may turn on and off over time and you may prefer to use these settings for keeping food warm. The food will however continue to cook gently if the grill is used for this purpose.



**The grill door must be left open when grilling.**

## THINGS TO NOTE

- The cooling fan for the controls may operate after a time.
- The Top oven **cannot** be operated when the grill is in use.
- Some smoke from fat splashes may be evident as the grill cleans itself.
- The inner element may appear to glow slightly brighter than the outer element. This is quite normal.

## THE GRILL PAN AND HANDLE

The grill pan is supplied with a removable handle.

To insert the handle, press the button on the handle with the thumb and pivot the handle slightly upwards inserting the lip into the widest part of the bracket. Move the handle towards the left, lower into position and release the button.



**Ensure the handle is positively located.**

When removing the handle, press the button on the handle with the thumb and pivot the handle slightly upwards and towards the right to remove from the bracket.



**Ensure your hand is protected when removing the grill pan handle as the control panel trim and grill element can become very hot.**



**Always remove the grill pan handle during grilling.**

To correctly locate the grill pan on the shelf, ensure that the cut out on the underside of the handle bracket locates over the front bar of the shelf.

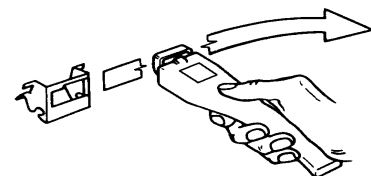

To check the progress of the food being grilled, the grill pan should be withdrawn on the shelf to tend the food during cooking.

### HINTS AND TIPS

- Food should be thoroughly dried before grilling to minimise splashing. Brush lean meats and fish lightly with a little oil or melted butter to keep them moist during cooking.
- Adjust the height of the grilling grid and grill pan runner position to allow for different thicknesses of foods.
- Place food on the grill pan or grid directly onto the grill pan base.
- Accompaniments such as tomatoes and mushrooms may be placed underneath the grid when grilling meats.
- When toasting bread use the shelf in position 1 with the grid in the high position and placing the bread in the centre of the grid.
- Preheat the grill on a full setting for five minutes before cooking. Adjust the heat setting and shelf as necessary during cooking.
- The food should be turned over during cooking as required.

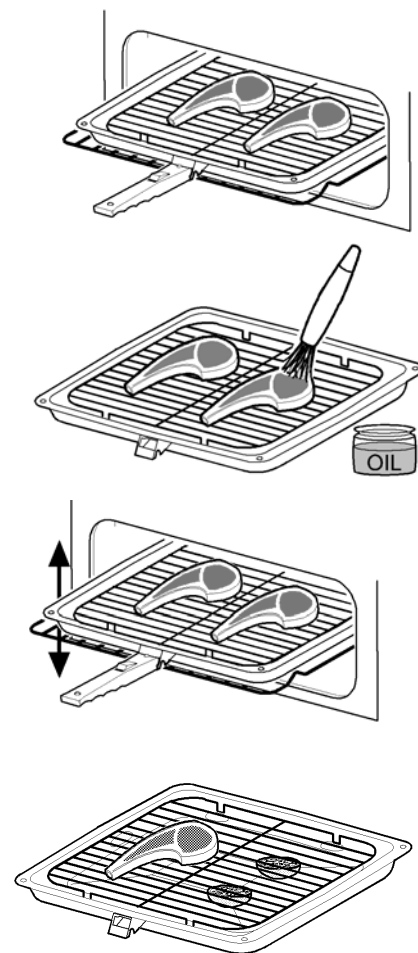

### GRILLING CHART

FOOD	RUNNER POSITION	GRILL TIME (mins in total)
Bacon Rashers	1	2-3 each side
Beefburgers	1	6-10 each side
Chicken Joints	1	15-20 each side
Chops - Lamb	1	7-10 each side
Pork	1	10-15 each side
Fish – Whole Trout/Mackerel	1	8-12 each side
Filletts – Plaice/Cod	1	4-6 each side
Kebabs	1	10-15 each side
Kidneys – Lamb/Pig	1	4-6 each side
Liver – Lamb/Pig	1	5-10 each side
Sausages	1	10-15 each side
Steaks - Rare	1	3-6 each side
Medium	1	6-8 each side
Well Done	1	7-10 each side
Toasted Sandwiches	1	1¼-1½ each side

Shelf positions are counted from the bottom up. The times quoted above are given as a guide and should be adjusted to suit personal taste.

# THE TOP OVEN

The top oven is the smaller of the two ovens. It is heated by elements in the top oven and bottom of the oven. It is designed for cooking smaller quantities of food. It gives especially good results if used to cook fruit cakes, sweet or savoury flans or quiche.

The top oven is also ideal for use as a warming compartment to warm dishes and keep food hot. Use the lowest setting on the top oven temperature control.

## USING THE TOP OVEN

- Turn the top oven temperature control to the required setting. Close the oven door.

## THINGS TO NOTE

- The cooling fan for the controls may operate after a time.
- The indicator neon will glow. It may turn ON and OFF during use to show that the setting is being maintained.
- The grill cannot be operated when the top oven is in use. Only the outer part of the top oven element in conjunction with the base element will operate when using the top oven.
- Always place plates on the oven shelf to warm.



**Do not place dishes, tins and trays directly on the oven base as it becomes very hot and damage will occur.**

## TO FIT THE TOP OVEN SHELF

The shelf should be fitted with the straight rods uppermost on the frame and the forms towards the back of the oven. If not fitted correctly the anti-tilt and safety stop mechanism will be affected.

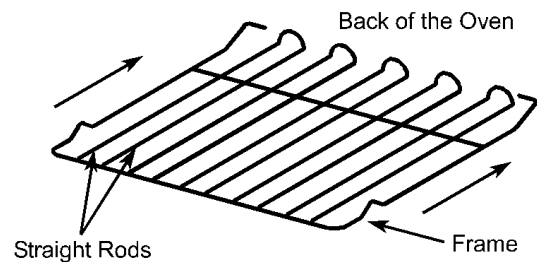
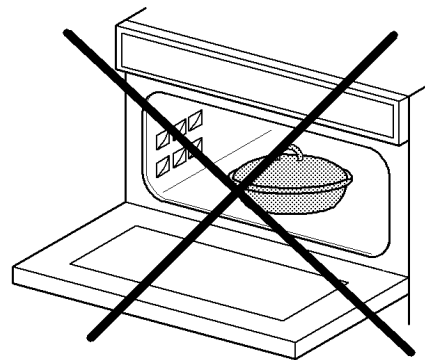
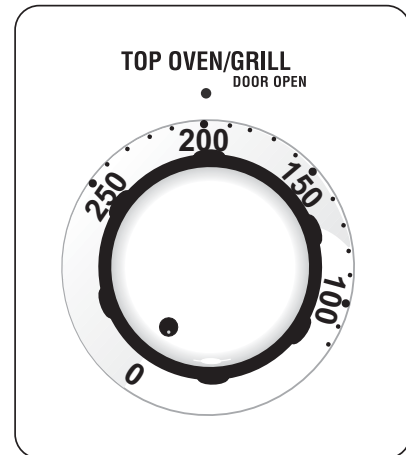

## HINTS AND TIPS

- All cooking should be carried out using an oven shelf positioned in one of the shelf runners.
- There should always be at least 2.5cm (1") between the top of the food and the element. This gives best cooking results and allows room for rise in yeast mixtures, Yorkshire puddings, etc. When cooking cakes, pastry, scones, bread, etc., place the tins or baking trays centrally on the shelf.
- Stand dishes on a suitably sized baking tray on the shelf to prevent spillage onto the oven base and to help reduce cleaning.
- The material and finish of the baking tray and dishes used affect base browning. Enamelware, dark, heavy or non-stick utensils increase base browning. Shiny aluminium or polished steel trays reflect the heat away and give less base browning.
- **DO NOT** place dishes directly onto the oven base as it becomes very hot and damage may occur.
- **DO NOT** use the grill pan as a baking tray as this will increase base browning of the food.
- Because of the smaller cooking space, lower temperatures and shorter cooking times are sometimes required.
- For economy leave the door open for the shortest possible time, particularly when placing food into a pre-heated oven.

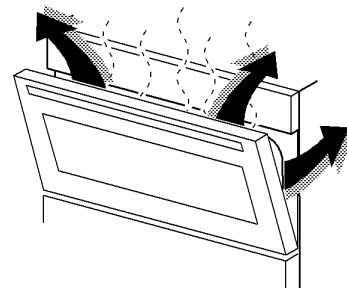
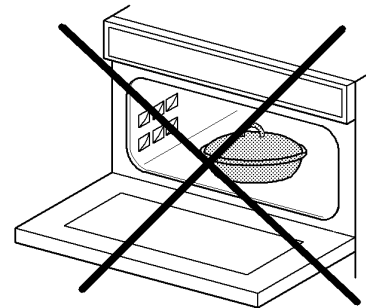
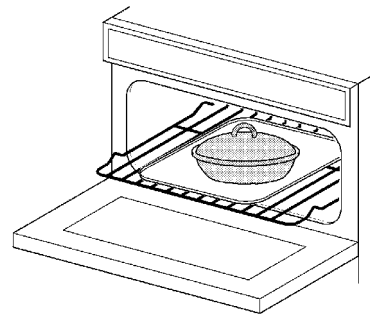
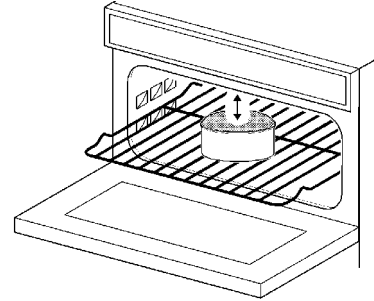
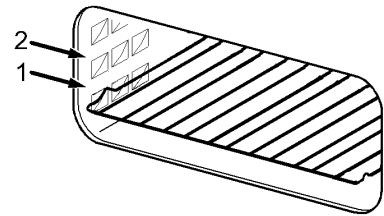

# THE MAIN FAN OVEN

The fan oven is particularly suitable for cooking larger quantities of food. The advantages of fan oven cooking are:

## PREHEATING

The fan oven quickly reaches its temperature, so it is not usually necessary to preheat the oven. Without preheating however, you may need to add an extra 5 – 10 minutes on the recommended cooking times. For recipes needing high temperatures, e.g. bread, pastries, scones, soufflés etc., best results are achieved if the oven is preheated first. For best results when cooking frozen or cooked chilled ready meals always preheat the oven first.

## COOKING TEMPERATURES

Fan oven cooking generally requires lower temperatures than conventional cooking. Follow the temperatures recommended in the cooking chart. As a guide reduce temperatures by about 20°C – 25°C for your own recipes, using a conventional oven.

## BATCH BAKING

The fan oven cooks evenly on both shelf levels, especially useful when batch baking.

## USING THE FAN OVEN

- Turn the fan oven temperature control to the required setting.

## THINGS TO NOTE

- The cooling fan for the controls may operate after a time.
- The indicator neon will glow. It may turn ON and OFF during use to show that the setting is being maintained.

## TO FIT THE FAN OVEN SHELVES

The shelves should be fitted with the straight rods uppermost on the frame and the forms towards the back of the oven. If not fitted correctly the anti-tilt and safety stop mechanism will be affected.

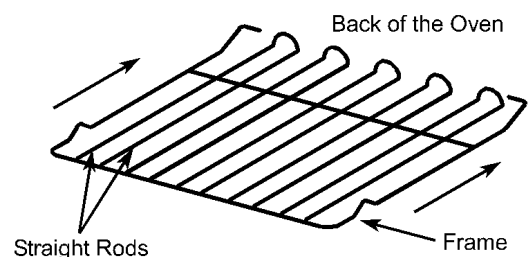



## HINTS AND TIPS

- Arrange the shelves in the required positions before switching the oven on. Shelf positions are numbered from the bottom upwards.
- When cooking more than one dish in the fan oven, place dishes centrally on different shelves rather than cluster several dishes on one shelf, this will allow the heat to circulate freely for the best cooking results.
- When batch baking one type of food, e.g. Victoria sandwich cakes, those of similar size will be cooked in the same time.
- It is recommended that when baking larger quantities the shelf positions should be evenly spaced to suit the load being cooked. A slight increase in cooking time may be necessary.
- The use of excessively high temperatures can cause uneven browning. It may be necessary to reduce temperatures slightly. Refer to the recommendations given in the oven cooking chart.
- **Do not** place baking trays directly on the oven base as it interferes with the oven air circulation and can lead to base burning; use the lower shelf position.

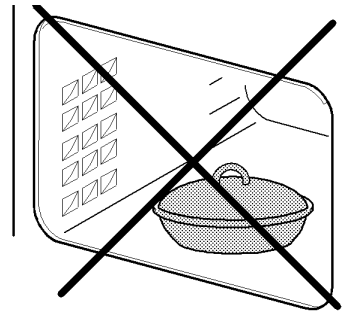
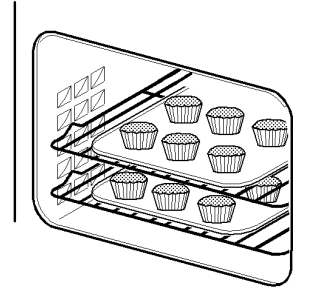
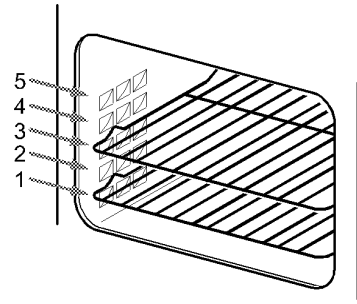

# OVEN COOKING CHART

The oven temperatures are intended as a guide only. It may be necessary to increase or decrease the temperatures by 10°C to suit individual preferences and requirements.

FOOD	FAN OVEN		TOP OVEN		
	SHELF POSITION	COOKING TEMP °C	SHELF POSITION	COOKING TEMP °C	APPROX COOK TIME (m)
Biscuits		180 - 190	1	170 - 190	10 - 20
Bread	Shelf	200 - 220	1*	200 - 220	25 - 30
Bread rolls/buns		200 - 220	1	200 - 220	15 - 20
Cakes:					
Small & Queen		160 - 170	1	180 - 190	18 - 25
Sponges		160 - 170	1	160 - 170	18 - 20
Victoria Sandwich	positions	160 - 170	1	160 - 170	18 - 25
Madeira		140 - 150	1	140 - 150	1¼ - 1½h
Rich Fruit		130 - 140	1	140 - 150	2¼ - 2½h
Christmas	are not	130 - 140	1	130 - 140	3 - 4½h
Gingerbread		140 - 150	1	140 - 150	depends on size 1¼ - 1½h
Meringues	critical	90 - 100	1	90 - 100	2½ - 3h
Flapjack		170 - 180	1	170 - 180	25 - 30
Shortbread		130 - 140	1	140 - 150	45 - 65
Casseroles:					
Beef/Lamb	but ensure	140 - 160	1*	140 - 160	2½ - 3h
Chicken		180 - 190	1*	180 - 190	1¼ - 1½h
Convenience Foods		Follow manufacturer's instructions			
Fish	that oven	170 - 190	1	170 - 190	20 - 30
Fish Pie (Potato Topped)		190 - 200	1*	190 - 200	20 - 25
Fruit Pies, Crumbles		190 - 200	1	190 - 200	40 - 50
Milk Puddings	shelves	130 - 140	1	140 - 150	1½ - 2h
Pasta Lasagne etc.		190 - 200	1	170 - 180	40 - 45
Pastry:					
Choux	are	190 - 200	1	180 - 190	30 - 35
Eclairs, Profiteroles		170 - 180	1	170 - 180	20 - 30
Flaky/Puff Pies		210 - 220	1*	210 - 220	25 - 40
Shortcrust					
Mince Pies	evenly	190 - 200	1	190 - 200	15 - 20
Meat Pies		190 - 210	1*	190 - 210	25 - 35
Quiche, Tarts, Flans		180 - 210	1	180 - 200	25 - 45
Roasting Meat, Poultry	spaced	160 - 180	1*	160 - 180	see roasting chart
Scones	when more	210 - 220	1	220 - 230	8 - 12
Shepherd's Pie		190 - 200	1*	190 - 200	30 - 40
Soufflés		170 - 180	1	170 - 180	20 - 30
Vegetables:					
Baked Jacket Potatoes	than one is	180 - 190	1	180 - 190	1 - 1½h
Roast Potatoes		180 - 190	1	180 - 190	1 - 1½h
Yorkshire Puddings:					
Large	used	210 - 220	1	200 - 210	25 - 40
Individual		200 - 210	1	200 - 210	15 - 25

\* = Shelf on the oven base.

**Note:** Shelf positions are counted from the bottom of the oven.

# ROASTING CHART

INTERNAL TEMPERATURES – Rare : 50-60°C; Medium : 60-70°C; Well done : 70-80°C		
MEAT	TEMPERATURE	COOKING TIME
Beef/ Beef boned	160-180°C	20-35 minutes per ½kg (1lb) and 20-35 minutes over
Mutton/Lamb	160-180°C	25-35 minutes per ½kg (1lb) and 25-35 minutes over
Pork/Veal/Ham	160-180°C	30-40 minutes per ½kg (1lb) and 30-40 minutes over
Chicken	160-180°C	15-20 minutes per ½kg (1lb) and 20 minutes over
Turkey/Goose	160-180°C	15-20 minutes per ½kg (1lb) up to 3½kg (7lb) then 10 minutes per ½kg (1lb) over 3½kg (7lb)
Duck	160-180°C	25-35 minutes per ½kg (1lb) and 25-30 minutes over
Pheasant	160-180°C	35-40 minutes per ½kg (1lb) and 35-40 minutes over
Rabbit	160-180°C	20 minutes per ½kg (1lb) and 20 minutes over

The roasting temperatures and times given in the chart should be adequate for most joints, but slight adjustments may be required to allow for personal requirements and the shape and texture of the meat. However, lower temperatures and longer cooking times are recommended for less tender cuts or larger joints.

Wrap joints in foil if preferred, for extra browning uncover for the last 20 – 30 min. cooking time.

# DEFROST FEATURE

This main fan oven function defrosts most foods faster than more conventional methods. It is particularly suitable for delicate frozen foods which are to be served cold e.g. cream filled gateaux, cakes covered with icings or frostings, cheesecakes, biscuits, scones, etc.

## USING DEFROST FEATURE

- Turn the fan oven temperature control to the defrost setting. 
- When defrost is selected, the oven indicator neon may come ON. It will stay ON until the oven reaches room temperature and then go OFF.
- It may turn ON and OFF periodically during defrosting to maintain a steady room temperature, inside the oven.

## THINGS TO NOTE

- The oven fan will come on.

## HINTS AND TIPS

- Place the frozen food in a single layer where possible and turn it over half way through the defrosting process.
- The actual speed of defrosting is influenced by room temperature. On warm days defrosting will be faster than on cooler days.
- It is preferable to thaw fish, meat and poultry slowly in the fridge. However, this process can be accelerated by using the defrost function. Small or thin fish fillets, frozen peeled prawns, cubed or minced meat, liver, thin chops, steaks etc., can be thawed in 1 – 2 hours.
- A 1kg/2¼lb oven ready chicken will be thawed in approximately 5 hours. Remove the giblets as soon as possible during the thawing process.
- Joints of meat up to 2kg/4½lb in weight can be thawed using the defrost function.
- All joints of meat and poultry must be thawed thoroughly before cooking.
- Always cook thoroughly immediately after thawing.
- **DO NOT** leave food at room temperature once it is defrosted. Cook raw food immediately or store cooked food in the fridge, once it has cooled.
- Care must always be taken when handling foods in the home. Always follow the basic rules of food hygiene to prevent bacterial growth and cross contamination when defrosting, preparing, cooking, cooling and freezing foods.

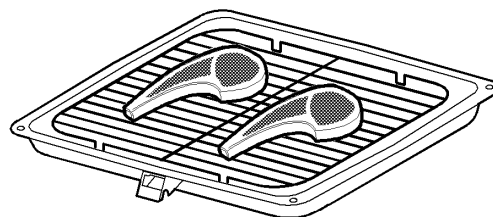
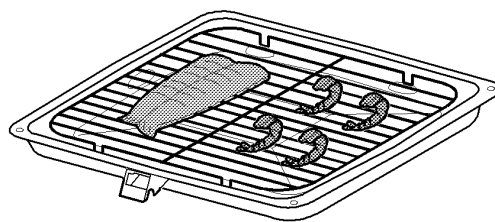
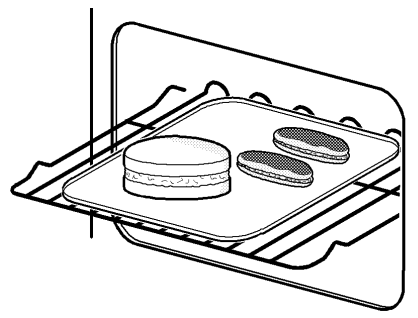
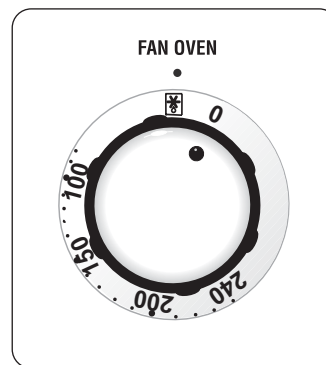

# CARE AND CLEANING



**Always switch off the electricity supply at the main wall switch and allow the appliance to cool before cleaning.**

## CLEANING MATERIALS

Before using any cleaning materials on your appliance, check that they are suitable and that their use is recommended by the manufacturer.

Cleaners that contain bleach should NOT be used as they may dull the surface finishes. Harsh abrasives and scourers should also be avoided. Multi-surface anti-bacterial cleaning products should not be used on the ceramic hob or on the surrounding trims.

## CLEANING THE OUTSIDE OF THE APPLIANCE

**DO NOT** use abrasive cleaning materials e.g. Hob Brite, Brillo pads or scourers on painted or printed finishes as damage may occur. Regularly wipe over the control panel, oven doors and appliance sides using a soft cloth and hot soapy water. To prevent streaking on stainless steel models finish with a soft cloth.

**Any spillage on the stainless steel finish must be wiped off immediately.**

Stainless Steel cream cleaners are abrasive and should be avoided as they may dull the surface finish.

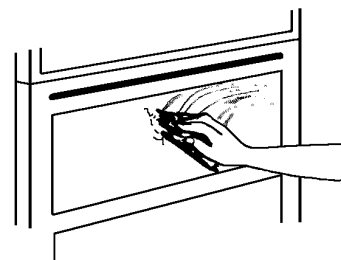

**Do not attempt to remove any of the control knobs from the appliance as this may cause damage and is a safety hazard.**

## CLEANING THE CONTROL KNOBS AND HANDLES

It is strongly recommended that only hot soapy water is used for cleaning the control knobs and handles. **THE USE OF ANY OTHER CLEANING MATERIALS MAY DULL THE FINISH.**

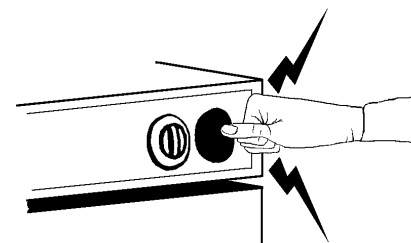

## CLEANING THE CERAMIC HOB

Make sure the ceramic glass is cool before cleaning. It is important to clean the ceramic hob daily to prevent soilage being burnt on.

Take care to avoid the hob trims when cleaning the ceramic glass as they may be damaged by the cleaning agents recommended.

## DAILY CLEANING

Use the recommended Hob Brite Cleaner daily. If soilage is not allowed to burn on it will be much easier to clean off.

1. Apply a small amount of Hob Brite in the centre of each area to be cleaned.
2. Dampen a clean paper towel or a plastic pad made specially for non-stick saucepans and rub vigorously until all marks are removed. This may take a few minutes.
3. Wipe off residues of cleaner with another damp paper towel and polish dry with a soft cloth.

If Hob Brite is unavailable, one or more of the cleaning agents below may be used temporarily:

- a) Cif Cream Cleaner
- b) Baking Soda

## TO REMOVE MORE STUBBORN MARKS

1. Bar Keepers Friend may be used to clean off more stubborn stains or to remove discolourations. It may be necessary to rub the marks hard for several minutes.
2. Use a plastic pad specially for non-stick saucepans with Bar-Keepers Friend for removal of more stubborn soilage.

## TO REMOVE BURNT ON SOILAGE

We strongly recommend the use of a Ceramic Hob Scraper (incorporating a single edge razor blade) to remove spillage on the hob, in particular sugar solutions, which if not removed can cause permanent damage.

1. Make sure the ceramic glass is cool.
2. Use a ceramic hob scraper with care at an angle of 30° to remove as much soilage as possible.
3. Use Bar-Keepers Friend or Hob Brite to finish off as directed above.

## TO REMOVE DISCOLOURATIONS OR WHITE AND SILVER MARKS

These marks sometimes give the impression of being in or underneath the hob glass. They can almost always be removed provided they have not become excessively burnt on. Follow the instructions above under 'To Remove more Stubborn Marks'.

If this is unsuccessful, make up a paste of one part water to three parts Cream of Tarter and leave on the discoloured areas overnight. The marks should be easily removable the next day provided they have not been excessively burnt on. The paste should be thoroughly washed off afterwards.

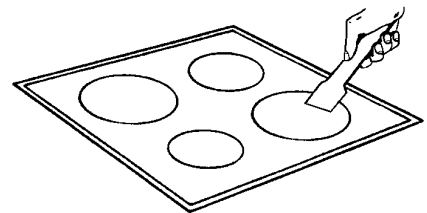
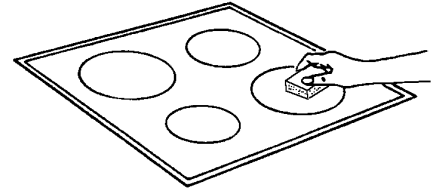
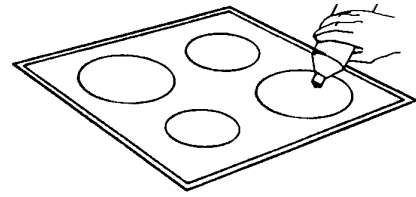

## HINTS AND TIPS

### TO REDUCE HOB SOILAGE:

- Make sure the bottom of the saucepan and the cooking area are clean and dry before cooking begins.
- Ensure saucepans are large enough to accommodate food to avoid boil overs.
- If possible, wipe up spills and splatters as they occur, but take care to avoid steam burns.
- Avoid using a dishcloth or sponge to clean the hob. These may leave a layer of soiled detergent on the hob surface which will burn and discolour the next time the hob is used.
- Avoid the use of:
  - Household detergents and bleaches.
  - Impregnated plastic or nylon pads that are not described as suitable for non-stick saucepans.
  - Brillo pads, Ajax pads, steel wool pads.
  - Chemical oven cleaners, e.g. aerosols and oven pads.
  - Rust stain, bath and sink stain removers.
- **Any of the above products may cause damage to the hob.**
- It is dangerous to mix different cleaning products. The chemicals in them may react with each other with hazardous results.
- **Soilage from sugar solutions must be removed from the hob before the syrup has set otherwise damage to the hob surface will occur.**
- Avoid placing plastic items, foil or dishes on the hot surface as this will cause damage to the hob.

### CLEANING THE GRILL AND OVEN FURNITURE

All removable parts, except the grill pan handle can be washed in the dishwasher.

The grill pan, grill pan grid and oven shelves may be cleaned using a soap impregnated steel wool pad. Soaking first in hot soapy water will make cleaning easier.

## CLEANING INSIDE THE GRILL AND OVEN COMPARTMENTS

The sides and back of the grill/top oven and main oven compartments are coated with a special Stayclean coating. They should not be cleaned manually.

The vitreous enamel main oven base and grill/top oven base can be cleaned using normal oven cleaners with care. Ensure that the manufacturers instructions are followed and that all parts are well rinsed afterwards.



**Aerosol cleaners must not come into contact with elements or the door seal as this may cause damage.**

### HINTS AND TIPS



**Aerosol cleaners must not be used on Stayclean surfaces.**

Stayclean surfaces destroy splashes of food and fats when the oven temperature is raised to around 220°C. It is a good idea to run the oven for an hour or two per week to ensure continued good performance from the Stayclean finish.

Slight discolouration and polishing of the Stayclean surfaces may occur in time. This **DOES NOT** affect the Stayclean properties in any way.

Use minimal, if any, extra oil or fat when roasting meat, potatoes only require brushing with fat before cooking. Extra fat in the oven during roasting will increase splashing and soilage.

It is **NOT** necessary to add water to a meat tin when roasting. The water and the fat juices from the joint create excessive splattering during cooking – even at normal temperatures, as well as causing condensation.

Covering joints during cooking will also prevent splashing onto the interior surfaces. Removing the covering for the last 20-30 minutes will allow extra browning if required. Some large joints and turkeys especially benefit by this method of cooking, allowing the joint to cook through before the outside is over-browned.

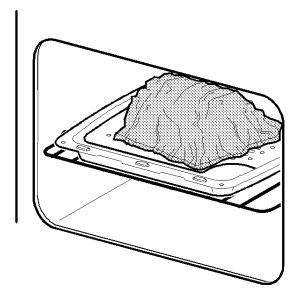
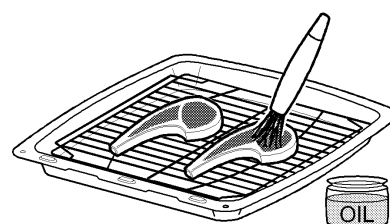

### CLEANING THE DOOR GLASS



**To prevent damaging or weakening the door glass panels avoid the use of the following:**

- Household detergents and bleaches
- Impregnated pads unsuitable for non-stick saucepans
- Brillo/Ajax pads or steel wool pads
- Chemical oven pads or aerosols
- Rust removers
- Bath/Sink stain removers



## CLEANING BETWEEN THE OUTER AND INNER DOOR GLASS

The outer door glass is removable for cleaning.

### TO REMOVE THE OUTER GLASS

1. Open the oven door slightly to gain access to the two cross head screws on the top of the oven door.
2. Loosen the two screws using a Pozidrive screwdriver.
3. Hold the door glass securely in place with one hand before removing the screws completely with the other hand.
4. Using both hands, gently tilt the top of the door glass towards you, lift slightly to disengage the locators from the two bottom brackets.
5. Clean the outer and inner glass using hot soapy water or Hob Brite cleaner may be used. **DO NOT** use Hob Brite on the Stainless Steel or painted finishes. **DO NOT** try to clean the foil which is inside the door. The foil is there to help keep the door cool, if it is damaged it will not work. Ensure that all parts are well rinsed and thoroughly dried before attempting to replace the outer door.



**If the door glass panel becomes chipped or has deep scratches the glass will be weakened and must be replaced to prevent the possibility of the panel shattering. Please contact your local Service Force Centre who will be pleased to advise further.**

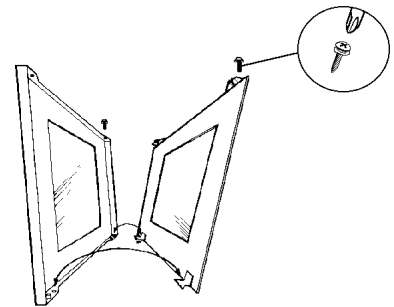

### TO REPLACE THE OUTER GLASS

1. Holding the oven glass with both hands, gently place the locators into the holes of the brackets at the bottom of the oven door.
2. Push the top of the oven glass towards the oven door, ensuring the screw location holes line up.
3. Hold the glass in place with one hand and insert the cross head screws into the location holes with the other hand. Give the screws one turn to ensure the glass is secure.
4. Tighten the screws positively with a Pozidrive screwdriver before closing the oven door.



**Do not attempt to use the oven without the glass being in place.**

### TO CLEAN THE INNER GLASS DOOR PANELS

Clean the inner glass door panels using a soft cloth and hot water to which a little washing up liquid has been added. If the inner panel is heavily soiled, Hob Brite may be used. **Do not** use abrasive cleaning materials on the door glass. Ensure that all parts are well rinsed and thoroughly dried before attempting to replace the glass.

# SOMETHING NOT WORKING?

Please carry out the following checks on your appliance before calling a Service Engineer. It may be that the problem is a simple one which you can solve yourself without the expense of a service call.

**In-guarantee customers should make sure that the checks have been made as the engineer will make a charge if the fault is not a mechanical or electrical breakdown.**

Please note that proof of purchase is required for in-guarantee service calls.

PROBLEM	POSSIBLE SOLUTION
<b>The grill, ovens and timer do not work.</b>	Check that the appliance has been wired in to the appliance supply and is switched on at the wall.  Check that the main appliance fuse is working.  Check that the timer instructions have been followed correctly.
<b>The hotplates and fan oven work but the grill does not.</b>	Check that you have carefully followed the instructions for operation of the grill.
<b>The indicator neons are not working correctly.</b>	Check that you have selected only the function you require. Ensure all other controls are in the Off position.
<b>The oven is not cooking evenly or the side opening door will not stay open.</b>	Check that the appliance is correctly installed and is level.  Check that the recommended temperatures and shelf positions are being used.
<b>The oven fan is noisy.</b>	Check that the oven is level.  Check that the shelves and bakeware are not vibrating in contact with the oven back panel.
<b>The oven temperature is too high or too low.</b>	Check that the recommended temperatures and shelf positions are being used. Be prepared to adjust the temperature up or down by 10°C to achieve the results you want.

# SERVICE AND SPARE PARTS

In the event of your appliance requiring service, or if you wish to purchase spare parts, please contact your local Service Force Centre by telephoning:-

**0870 5 929929**

Your telephone call will be automatically routed to the Service Force Centre covering your post code area.

For the address of your local Service Force Centre and further information about Service Force, please visit the website at [www.serviceforce.co.uk](http://www.serviceforce.co.uk).

Before calling out an engineer, please ensure you have read the details under the heading "Something Not Working?".

When you contact the Service Force Centre you will need to give the following details:

1. Your name, address and post code.
2. Your telephone number.
3. Clear and concise details of the fault.
4. The model and serial number of the appliance (found on the rating plate).
5. The purchase date.

**Please note that a valid purchase receipt or guarantee documentation is required for in-guarantee service calls.**

For Customer Service in Ireland please contact us at the address below:

Zanussi-Electrolux  
Electrolux Group (Irl) Ltd  
Long Mile Road  
Dublin 12  
Republic of Ireland

Tel: +353 (0) 1 4090751

Email: [service.eid@electrolux.ie](mailto:service.eid@electrolux.ie)

## CUSTOMER CARE DEPARTMENT

For general enquires concerning your Zanussi-Electrolux appliance, or for further information on Zanussi-Electrolux products, please contact our Customer Care Department by letter or telephone at the address below or visit our website at [www.zanussi-electrolux.co.uk](http://www.zanussi-electrolux.co.uk)

Customer Care Department  
Zanussi-Electrolux  
55 – 77 High Street  
Slough  
Berkshire  
SL1 1DZ  
Tel: 0870 5 727727 (\*)

\*calls to this number may be recorded for training purposes.

# GUARANTEE CONDITIONS

## Standard guarantee conditions

We, Zanussi-Electrolux, undertake that if within 12 months of the date of the purchase this ZANUSSI-ELECTROLUX appliance or any part thereof is proved to be defective by reason only of faulty workmanship or materials, we will, at our option repair or replace the same FREE OF CHARGE for labour, materials or carriage on condition that:

- The appliance has been correctly installed and used only on the electricity supply stated on the rating plate.
- The appliance has been used for normal domestic purposes only, and in accordance with the manufacturer's instructions.
- The appliance has not been serviced, maintained, repaired, taken apart or tampered with by any person not authorised by us.
- All service work under this guarantee must be undertaken by a Service Force Centre.
- Any appliance or defective part replaced shall become the Company's property.
- This guarantee is in addition to your statutory and other legal rights.

Home visits are made between **8.30am** and **5.30pm** Monday to Friday. Visits may be available outside these hours in which case a **premium** will be charged.

## Exclusions

**This guarantee does not cover:**

- Damage or calls resulting from transportation, improper use or neglect, the replacement of any light bulbs or removable parts of glass or plastic.
- Costs incurred for calls to put right an appliance which is improperly installed or calls to appliances outside the United Kingdom.
- Appliances found to be in use within a commercial environment, plus those which are subject to rental agreements.
- Products of Zanussi-Electrolux manufacture which are not marketed by Zanussi-Electrolux.

## European Guarantee

If you should move to another country within Europe then your guarantee moves with you to your new home subject to the following qualifications:

- The guarantee starts from the date you first purchased your product.
- The guarantee is for the same period and to the same extent for labour and parts as exists in the new country of use for this brand or range of products.
- This guarantee relates to you and cannot be transferred to another user.
- Your new home is within the European Community (EC) or European Free Trade Area.
- The product is installed and used in accordance with our instructions and is only used domestically, i.e. a normal household.
- The product is installed taking into account regulations in your new country.

Before you move please contact your nearest Customer Care centre, listed below, to give them details of your new home. They will then ensure that the local Service Organisation is aware of your move and able to look after you and your appliances.

France	Senlis	+33 (0) 3 44 62 29 29
Germany	Nürnberg	+49 (0) 800 234 7378
Italy	Pordernone	+39 (0) 0434 39 4700
Sweden	Stockholm	+46 (0) 8 672 53 90
UK	Slough	+44 (0) 1753 219897
Ireland	Dublin	+353 (0) 1 4090751

# TECHNICAL DETAILS

## MODEL NO. ZCE5000 / ZCE5001

Voltage:	230-240 Volts AC 50Hz
Wattage:	9.8-10.7kW
Height:	900mm
Width:	500mm
Depth:	500mm
Weight:	55 kg

 This appliance complies with: European Council Directive 73/23/EEC.  
EMC Directive 89/336/EEC.  
CE Marking Directive 93/68/EEC

# INSTALLATION INSTRUCTIONS

**WARNING: THIS APPLIANCE MUST BE EARTHED**

If your appliance has been damaged in transit, contact your supplier immediately. **DO NOT** attempt to install it.

Your appliance left the factory fully packaged to protect it from damage. If it is delivered without packaging and damage has occurred, the manufacturer cannot accept responsibility. Contact your supplier for advice.

Once the packaging has been removed the appliance should only be moved by hand. **DO NOT** use a sack barrow or any other aid to lift the appliance as damage may occur.

Connection to the electricity supply must be carried out by a qualified electrician/competent person.

The electrical connection should be made using a double pole isolating switch (cooker socket) with at least 3mm contact separation in all poles. The cable must have conductors of sufficiently high cross-sectional area to prevent overheating and deterioration.

The recommended cross-section area is six square millimetres (6.00mm<sup>2</sup>).

The cable should be routed away from potentially hot areas marked by X. See Fig.1.

To move the appliance, open the oven door, and lift the appliance by holding inside the top of the compartment. See Fig.2.

This is a type X appliance, which means it is free-standing and can be fitted with cabinets on one or both sides. It may also be fitted in a corner setting.

Side walls which are above hob level should be protected by heat resistant non-combustible material and **MUST NOT** be nearer than 40mm to the hob side.

A nominal air gap of 2mm at either side of the appliance is required to enable the appliance to be moved into position.

Always ensure an air gap is maintained at hotplate level. Tiles or other forms of deep wall covering should not obscure this gap. See Fig.3.

Overhanging surfaces or a cooker hood should be a minimum of 685mm above the hob. See Fig.4.

It is important to ensure that the appliance is level after installation. Levelling feet are fitted to the appliance to accommodate uneven floors.

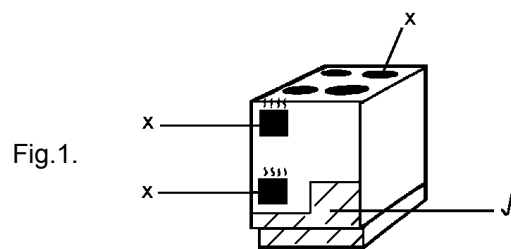

Fig.1.

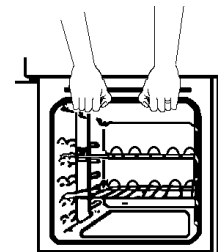

Fig.2.

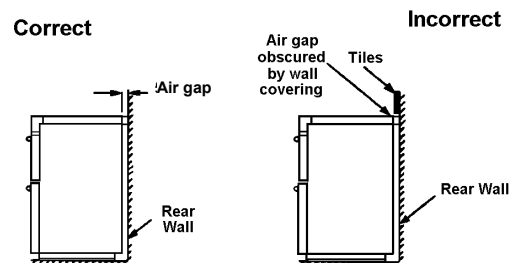

Fig.3.

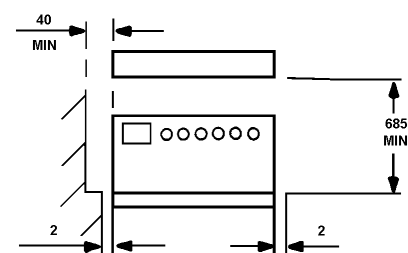

Fig.4.

## NOTES

## IMPORTANT NOTICE

In line with our continuing policy of research and development, we reserve the right to alter models and specifications without prior notice.

This instruction booklet is accurate at the date of printing, but will be superseded if specifications or appearance are changed.

ZANUSSI-ELECTROLUX  
55 – 77 HIGH STREET,  
SLOUGH,  
BERKSHIRE,  
SL1 1DZ.  
TELEPHONE 0870 5 727727  
[www.zanussi-electrolux.co.uk](http://www.zanussi-electrolux.co.uk)

Part Number: 311721000

© Electrolux plc 2004

 **From the Electrolux Group.** *The world's No.1 choice.*

*The Electrolux Group is the world's largest producer of powered appliances for kitchen, cleaning and outdoor use. More than 55 million Electrolux Group products (such as refrigerators, cookers, washing machines, vacuum cleaners, chain saws and lawn mowers) are sold each year to a value of approx. USD 14 billion in more than 150 countries around the world.*



**This file has been downloaded from:**

[www.UsersManualGuide.com](http://www.UsersManualGuide.com)

User Manual and User Guide for many equipments like mobile phones, photo cameras, mother board, monitors, software, tv, dvd, and othes..

Manual users, user manuals, user guide manual, owners manual, instruction manual, manual owner, manual owner's, manual guide, manual operation, operating manual, user's manual, operating instructions, manual operators, manual operator, manual product, documentation manual, user maintenance, brochure, user reference, pdf manual