

# SANTO 70388 KG



Electronic Refrigerator/Freezer

Operating Instructions

## Dear customer,

Before placing your new refrigerator/freezer into operation please read these operating instructions carefully. They contain important information for safe use, for installation and for care of the appliance.

Please keep these operating instructions for future reference. Pass them on to possible new owners of the appliance.



Notes which are important for your safety or for the proper functioning of the appliance are stressed with a warning triangle and/or with signal words (**Warning!**, **Caution!**, **Important!**). Please observe the following carefully.



1. This symbol and numbered instructions guide you step by step in the operation of the appliance.

2. ....



Supplementary information regarding operation and practical uses of the appliance appear after this symbol.



Tips and notes concerning economical and environmentally sound use of the appliance are marked with the cloverleaf.

Explanations of the technical terminology used in the operating instructions can be found at the end in the section "Technical Terminology".

The operating instructions contain instructions for the correction of possible malfunctions by the user in the section "What to do if ...". If these instructions should not be sufficient, please contact your local AEG Service Force Centre.

Printed on paper manufactured with environmentally sound processes.  
he who thinks ecologically acts accordingly ...

---

# Contents

<b>Important Safety Instructions</b> .....	5
<b>Environmental Information</b> .....	7
Packaging .....	7
Old Appliances .....	7
<b>Appliance Transport</b> .....	7
<b>Before Use</b> .....	8
Packaging .....	8
<b>Fitting the Door Handles</b> .....	9
<b>Installation</b> .....	10
Installation Location .....	10
The refrigerator/freezer needs ventilation .....	11
Appliance Alignment .....	11
Electrical Connection .....	12
<b>Reversing The Door</b> .....	13
<b>Appliance Description</b> .....	17
View of Appliance .....	17
Freezer tray .....	18
Cold Accumulation Block .....	18
Control Panel .....	19
Temperature setting buttons .....	20
Temperature Displays .....	20
ALARM OFF button .....	21
<b>Prior to Initial Start-Up</b> .....	21
<b>Initial Start-Up</b> .....	22
<b>Temperature Adjustment</b> .....	23
<b>COOLMATIC/FROSTMATIC</b> .....	24
COOLMATIC .....	24
FROSTMATIC .....	24
<b>Switching the Appliance Off</b> .....	25
<b>Holiday Mode</b> .....	26

<b>Control and Information Systems</b> .....	27
"Open Door"-Warning .....	27
Temperature Warning .....	27
Function Errors .....	28
<b>Opening the Freezer Compartment Door</b> .....	28
<b>Interior Accessories</b> .....	29
Storage Shelves .....	29
Variable Inner Door .....	29
Bottle rack .....	29
Bottle Holder .....	30
<b>Correct storage</b> .....	31
<b>Freezing</b> .....	32
<b>Frozen Storage</b> .....	33
<b>Storage Goods Symbols/Freezing Calendar</b> .....	33
<b>Preparation of Ice Cubes</b> .....	34
<b>Defrosting</b> .....	34
The refrigerator is defrosted automatically .....	34
Freezer Compartment Defrosting .....	34
<b>Hints and Tips</b> .....	35
Normal Operating Sounds .....	35
Food Storage .....	35
Energy Saving Advice .....	36
<b>Maintenance and Cleaning</b> .....	36
Internal Cleaning .....	37
External Cleaning .....	37
Replacing the light bulb .....	38
<b>What to do if .....</b>	39
<b>Regulations, Standards, Guidelines</b> .....	40
<b>Technical Terminology</b> .....	41
<b>Guarantee Conditions</b> .....	42
<b>Service &amp; Spare Parts</b> .....	43



## Important Safety Instructions

These warnings are provided in the interests of your safety. Ensure that you understand them all before installing or using this appliance. Your safety is of paramount importance. If you are unsure about any of the meanings of these warnings contact the Customer Care Department.

### Prior to Installation

- Check the refrigerator/freezer for transport damage. Under no circumstances should a damaged appliance be installed! In the event of damage, please contact your retailer.

### Installation

- This appliance is heavy. Care should be taken when moving it.
- It is dangerous to alter the specifications or attempt to modify this product in any way.
- Ensure that the appliance does not stand on the electrical supply cable. If the supply cable is damaged, it must be replaced by a cable available from your local Service Force Centre.
- Make sure that the power plug is not squashed or damaged by the back of the fridge/freezer. A damaged power plug may overheat and cause a fire.
- If the power plug socket is loose, do not insert the power plug. There is a risk of electric shock or fire.
- Any electrical work required to install this appliance should be carried out by a qualified electrician or competent person.
- Parts which heat up should not be exposed. Whenever possible, the back of the appliance should be close to a wall, but leaving the required distance for ventilation, as stated in the installation instructions.
- The appliance should be left for 2 hours after installation before it is turned on, in order to allow the refrigerant to settle.

### Refrigerant

The refrigerant isobutane (R600a) is contained within the refrigerant circuit of the appliance, a natural gas with a high level of environmental compatibility, which is nevertheless flammable.

- During transportation and installation of the appliance, be certain that none of the components of the refrigerant circuit become damaged.

- If the refrigerant circuit should become damaged:
  - avoid open flames and sources of ignition;
  - thoroughly ventilate the room in which the appliance is situated.

### **Child Safety**

- Do not allow children to tamper with the controls or play with the product.
- Keep packaging material away from children! (There is a risk of suffocation!)

### **During Use**

- This appliance is designed for domestic use only, specifically for the storage of edible foodstuffs only. It is not intended for commercial or industrial use
- Containers with flammable gases or liquids can leak at low temperatures. Do not store any containers with flammable materials such as, spray cans, fire extinguisher refill cartridges etc in the freezer.
- Frozen food should not be refrozen once it has thawed out.
- Do not place carbonated or fizzy drinks in the freezer.
- Ice lollies can cause 'frost/freezer burns' if consumed straight from the freezer compartment.
- Do not remove items from the freezer compartment if your hands are damp/wet, as this could cause skin abrasions or frost/freezer burns.
- Bottles and cans must not be placed in the freezer. They can burst when the contents freeze.
- Manufacturers' recommended storage times should be adhered to. Refer to relevant instructions.

### **Maintenance and Cleaning**

- Before cleaning, always switch off the appliance and disconnect from the electrical supply.
- When unplugging always pull the plug from the mains socket, do not pull on the cable. Damage to the cord may cause a short circuit, fire and/or electric shock.

### **Servicing**

- This product should be serviced by an authorised engineer and only genuine spare parts should be used.
- Under no circumstances should you attempt to repair the appliance yourself. Repairs carried out by inexperienced persons may cause injury or serious malfunctioning.  
Contact your local AEG Service Force Centre.

# Environmental Information

## Packaging

All transit packaging materials are environmentally compatible and can be reused. Wood is un-treated. The plastics can be recycled and are identified as follows:

>PE< for polyethylene, e.g. the outer covering and the bags in the interior.

>PS< for polystyrene foam, e.g. the pads, which are pure hydrocarbon compounds and can be recycled.

The carton parts are made from recycled paper. Please dispose of the packaging with due care for the environment.

## Old Appliances

When disposing of your old appliance:

Make the appliance unusable by cutting off the cable and remove any door catches to ensure small children cannot be trapped inside.

Help to keep your country tidy - use an authorised disposal site.

## Appliance Transport

Two persons are required for transport of the appliance. There are two recessed handles at the front of the base and at the back of the appliance at the top for improved gripping.

1. Grip the appliance with the recessed handles positioned as in the drawing, and transport the appliance.

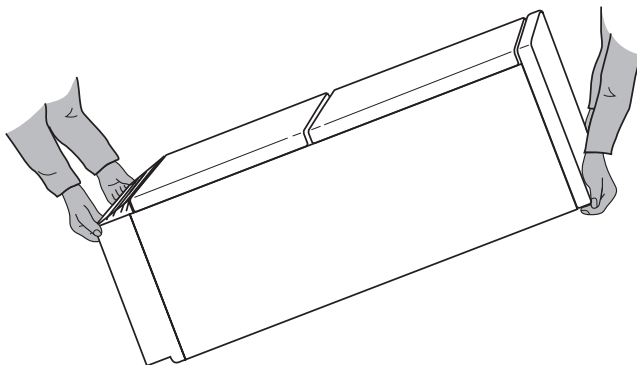

2. In order to push the appliance into its final position, press carefully at the top of the door and tip the appliance back slightly. The weight is thus transferred to the back wheels and the appliance can be easily pushed.

## Before Use

### Packaging

1. Remove all adhesive tape and packaging from the interior of the appliance.

**i** Any remnants of adhesive can be removed with white spirit.

2. Remove the transport protection pieces and pull off the adhesive tape.

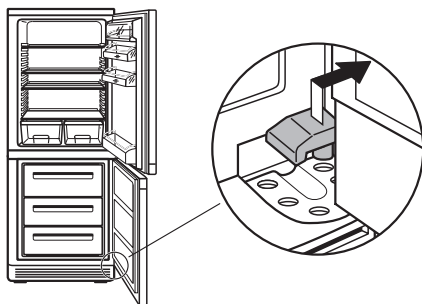
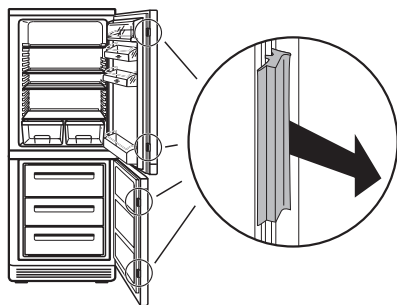

3. Wash the inside of the appliance with lukewarm water with a little bicarbonate of soda added (5 ml to 0.5 litre of water). Do not use soap or detergent as the smell may linger. Dry the appliance thoroughly.



Remove the transport fittings from the storage shelves:

- Slide the fittings securing the shelf forward to the thicker section on the edge of the storage shelf.
- Slide the storage shelf far enough forward so that it can be hinged downwards and the fittings can be removed from the guides.

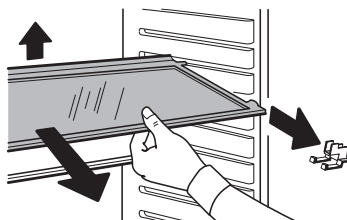
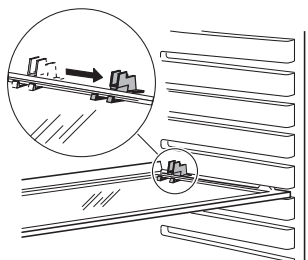

## Fitting the Door Handles



**Caution!** Do not overtighten the screws (max. 2 Nm) as you may damage the door handles.

-  1. Screw the top handle bracket to the handle rod (1). Fit the bottom handle bracket on the lower left-hand side of the door (2).

1

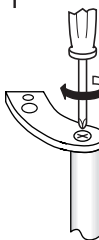

2



2. Fit the top handle bracket on the top left-hand side of the door (3) and screw the handle rod to the bottom handle bracket (4).

3

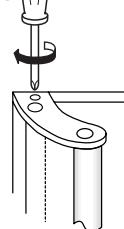

4

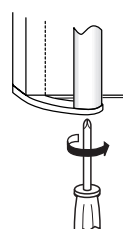

# Installation

## Installation Location

The appliance should be installed in a well ventilated, dry room.

Energy use and efficient performance of the appliance is affected by the ambient temperature.

The appliance should therefore

- not be exposed to direct sunlight;
- not be installed next to radiators, cookers or other sources of heat;
- only be installed at a location whose ambient temperature corresponds to the climate classification, for which the appliance is designed.

The climate classification can be found on the rating plate, which is located at the left on the inside of the appliance.

The following table shows which ambient temperature is correct for each climate classification:

Climate classification	for an ambient temperature of
SN	+10 to +32 °C
N	+16 to +32 °C
ST	+18 to +38 °C
T	+18 to +43 °C

If installation next to a source of heat is unavoidable, the following minimum clearances must be maintained at the sides of the appliance:

- for electric cookers 3 cm;
- for oil and coal fired ranges 30 cm.

If these clearances cannot be maintained a heat insulating pad is required between the cooker and the refrigeration appliance.

## The refrigerator/freezer needs ventilation

Air is fed under the door through the vent slots in the base and is exhausted upwards along the back wall. To ensure proper air circulation never cover or alter the vent openings.

**Important!** If the appliance is installed under a hanging cabinet, a clearance of at least 10 cm between the top of the appliance and the cabinet above it must be maintained.

Please check whether, after installing your appliance and especially after reversing the door, the door seal seals tightly. A badly fitting door seal may lead to heavy frosting and a higher power consumption (see also "What to do if ...").

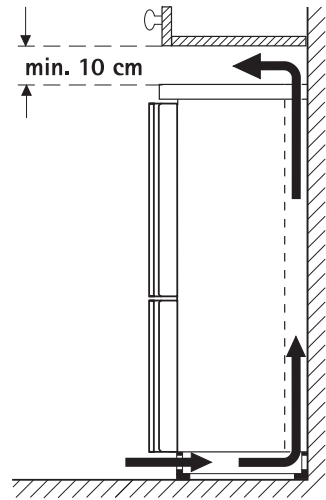

## Appliance Alignment

1. The appliance must be level. Please compensate for unevenness in the floor by turning the two adjustable feet at the front.

## Electrical Connection

Any electrical work required to install this appliance should be carried out by a qualified electrician or competent person.



### WARNING – THIS APPLIANCE MUST BE EARTHED

The manufacturer declines any liability should these safety measures not be observed.

Before switching on, make sure the electricity supply voltage is the same as that indicated on the appliance rating plate. The rating plate is inside, on the left.

The appliance is supplied with a 13 amp plug fitted. In the event of having to change the fuse in the plug supplied, a 13 amp ASTA approved (BS 1362) fuse must be used.

### Important

The wires in the mains lead are coloured in accordance with the following code:

Green and Yellow	Earth
Blue	Neutral
Brown	Live

As the colours of the wires in the mains lead of this appliance may not correspond with the coloured markings identifying the terminals in your plug, proceed as follows:

1. The wire coloured green and yellow must be connected to the terminal marked with the letter "E" or by the earth symbol  $\oplus$  or coloured green and yellow.
2. The wire coloured blue must be connected to the terminal "N" or coloured black.
3. The wire coloured brown must be connected to the terminal marked "L" or coloured red.
4. Upon completion there must be no cut, or stray strands of wire present and the cord clamp must be secure over the outer sheath.

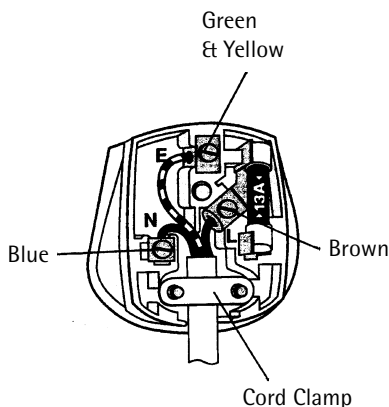

**Warning!** A cut-off plug inserted into a 13 amp socket is a serious safety (shock) hazard. Ensure that the cut-off plug is disposed of safely.

# Reversing The Door

The door hinges can be changed from right (as supplied) to left if required to suit the location where the appliance is installed.



**Warning!** Unplug from the mains, before reversing the door.

1. Open the freezer compartment door and remove the plinth to the front. Move the door bearing cover on the plinth from the left to the right.

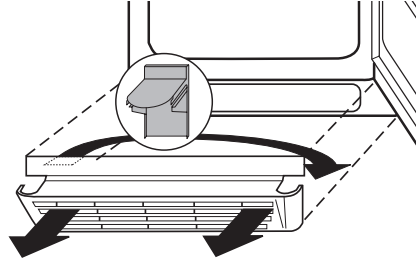

2. Close the freezer compartment door. Open the fridge compartment door and unscrew the retaining screw for the self-closing mechanism on the top of the freezer compartment door.

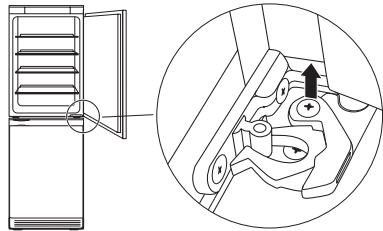

3. With the freezer compartment door closed, remove the cross-head screws from the lower door bearing and remove the door bearing downwards.

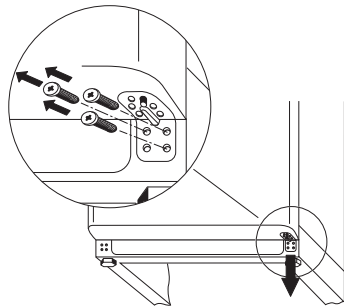

4. Move the bearing pivot from the right to the left hand hole. Remove the freezer compartment door carefully to the front and place on one side.

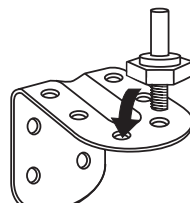

- 5. Unscrew the centre door bearing.
- 6. Remove the fridge compartment door carefully to the front and place on one side.

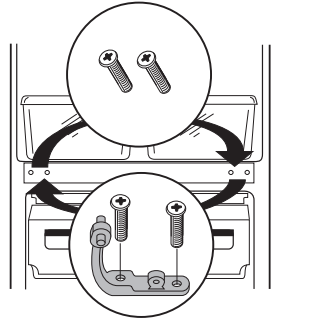

- 7. Unscrew the retaining screw for the self-closing mechanism on the bottom of the fridge compartment door.

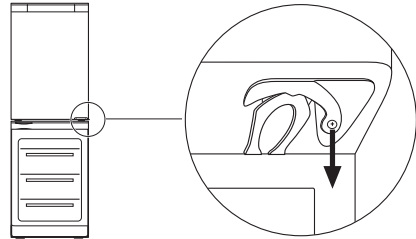

- 8. Move the upper bearing pivot to the left.

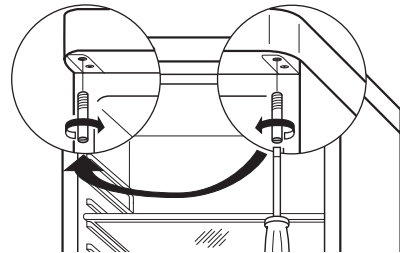

- 9. Unscrew the top handle bracket from the handle rod (1). Unscrew the bottom handle bracket from the door (2).

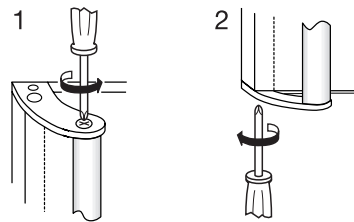

- 10. Unscrew the top handle bracket from the door (3) and screw onto the bottom right-hand side of the door (4).

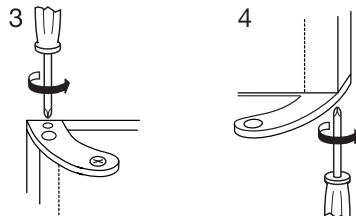

**Caution!** Do not use excessive force and overtighten the screws (max. 2 Nm) as you may damage the door handles.

11. Turn the handle bracket with the handle rod 180° and screw them to the door (5) and the fitted handle bracket (6).



**Caution!** Do not use excessive force and overtighten the screws (max. 2 Nm) as you may damage the door handles.

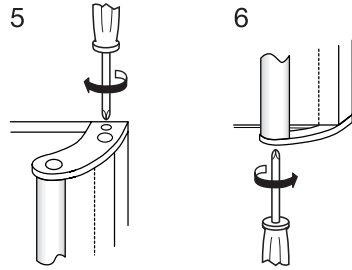

12. Fasten the self-closing mechanism to the bottom left of the fridge compartment door.

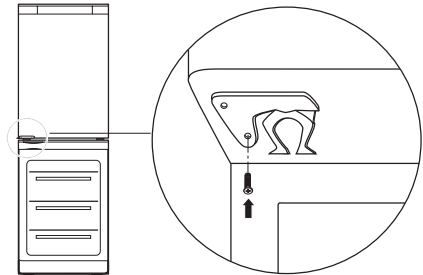

13. Carefully slide the fridge compartment door onto the top bearing pivot and close.

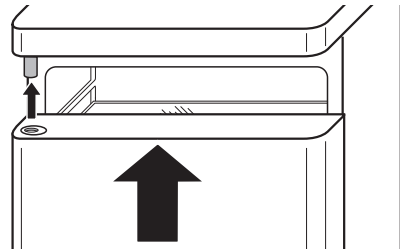

14. Slide the centre door bearing into the bottom left of the fridge compartment door and fasten to the housing.

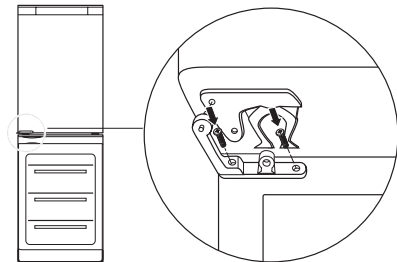

15. Fasten the self-closing mechanism on the top left of the freezer compartment door.

16. Carefully slide the freezer compartment door onto the centre bearing pivot and close.

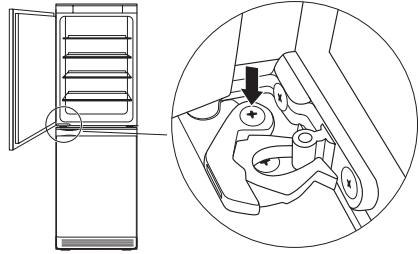

17. Place the lower door bearing with the bearing pivot in the lower left of the freezer compartment door and fasten.

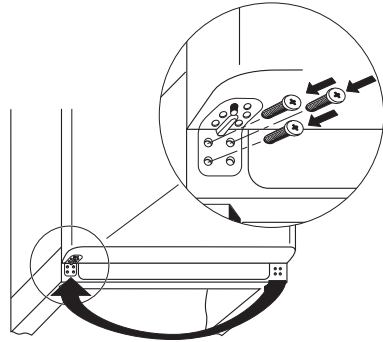

18. Open the freezer compartment door and fit the plinth.



# Appliance Description

## View of Appliance

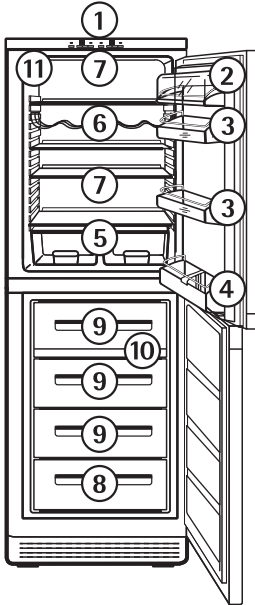

- ① Control panel
- ② Butter and cheese compartment with lid
- ③ Door storage compartments
- ④ Bottle compartment
- ⑤ Fruit and vegetable drawers
- ⑥ Bottle rack
- ⑦ Shelves
- ⑧ Freezer drawer (only for storage)  
When defrosting the bottom drawer also serves as a water collecting vessel.
- ⑨ Freezer drawer (for storage and freezing)
- ⑩ Freezer tray
- ⑪ Rating plate

## Freezer tray

A freezer tray is included below the upper drawer in the freezer compartment.

Berries and vegetables, for example, can be pre-frozen on the freezer tray.

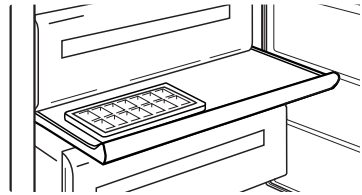

Advantage: The berries are not squeezed and maintain their natural form. The frozen berries can then be stored in compartments or drawers packaged in individual portions.

## Cold Accumulation Block

A cold accumulation block is enclosed with the appliance.



In the event of power failure or a malfunction of the appliance, the cold accumulation block will increase the hold over period by several hours. The cold accumulation block will be most effective when placed at the front of the upper freezer tray.

When defrosting the appliance place the cold accumulation block on top of the frozen food to keep it cold.

The block may also be used in a cool bag to keep the temperature of food down during transportation.

Refer to the section "Prior to Initial Start-Up" regarding the freezing of the cold accumulation block.

## Control Panel

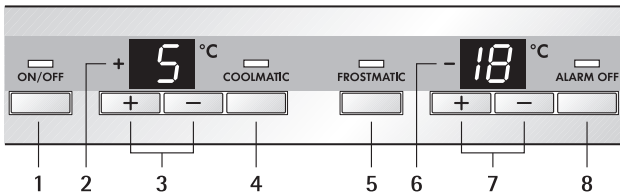

- 1 ON/OFF button and ON/OFF indicator light (green)
- 2 Temperature display for refrigerator
- 3 Temperature setting buttons for refrigerator
- 4 COOLMATIC button and COOLMATIC indicator light (yellow)
  - COOLMATIC for intensive cooling in the refrigerator
- 5 FROSTMATIC button and FROSTMATIC indicator light (yellow)
  - FROSTMATIC for fast freezing in the freezer compartment
- 6 Temperature display for freezer compartment
- 7 Temperature setting buttons for freezer compartment
- 8 ALARM OFF button and warning indicator light (red)  
(see section: "Control and Information Systems")

## Temperature setting buttons



The temperature is adjusted using the „+“ (WARMER) and „-“ (COLDER) buttons.

These buttons are connected to the temperature display.

- The temperature display is switched over from the display of the ACTUAL temperature (Temperature display is illuminated) to the display of the DESIRED temperature (Temperature display flashes) by pressing one of the two buttons, „+“ (WARMER) or „-“ (COLDER).
- Each time one of the two buttons is pressed again the DESIRED temperature is adjusted by 1 °C.
- If neither button is pressed, the temperature display automatically switches back after a short period (approx. 5 sec.) to the display of the ACTUAL temperature.

DESIRED temperature means:

The temperature that has been selected for inside the fridge or the freezer compartment. The DESIRED temperature is indicated by flashing numbers.

ACTUAL temperature means:

The temperature display indicates the current temperature inside the fridge or the freezer compartment. The ACTUAL temperature is indicated with static illuminated numbers.

-  Once the COOLMATIC- or the FROSTMATIC function has been switched on the DESIRED temperature that was set originally for the fridge or the freezer cannot be changed.

## Temperature Displays



The temperature displays shows several types of information.

- During normal operation, the temperature currently present in the fridge or the freezer compartment (ACTUAL temperature) is displayed.
- When the temperature is being adjusted a flashing display indicates the fridge or the freezer compartment temperature currently set (DESIRED temperature).
- If there is a fault in the appliance the temperature display shows:
  - a square or a letter in the temperature display of the fridge for a fault in the fridge,
  - a square or a letter in the temperature display of the freezer for a fault in the freezer.

## ALARM OFF button



With the ALARM OFF button, the acoustic warning signal can be switched off, e.g. the "Open Door" warning when sorting in or out, the food to be chilled or frozen.

When there is a temperature warning for the freezer compartment, if the ALARM OFF button is activated, the temperature display will show the warmest temperature the frozen food has reached.

## Prior to Initial Start-Up



Before connecting the appliance to the mains and putting it into operation for the first time, leave the appliance to stand for 30 minutes if was transported upright. After transport on its side, the appliance must be left to stand for 2 hours before putting it into operation. This is necessary to allow the oil to flow back into the compressor. Otherwise the compressor may be damaged.

1. Please clean the appliance interior and all accessories prior to initial start-up (see section: "Maintenance and Cleaning").
2. The appliance must be correctly installed in accordance with the chapter "Installation" before it is put into operation for the first time. Care should be especially taken that the mains voltage and frequency available correspond with the appliance's rating plate.
3. Remove the cold accumulation block from the appliance.
4. Place the cold accumulation block into a drawer only after the optimal storage temperature of  $-18\text{ }^{\circ}\text{C}$  has been reached, and allow to freeze.
5. After 24 hours place the cold accumulation block at the front of the upper drawer.
6. Re-freeze the thawed cold accumulation block in the same fashion, e.g. after cleaning the appliance.

# Initial Start-Up

1. Insert plug into mains socket.
2. Press the ON/OFF button.  
The green power indicator lights up. A warning tone sounds and the flashing red warning light indicates that the required storage temperature has not yet been reached. The temperature displays shows the current, actual refrigerator and freezer temperature. The compressor will start and then run automatically.
3. Press the ALARM OFF button to switch off the warning tone.
4. Set the refrigerator to the desired temperature (see section: "Temperature Adjustment").
- i** Goods to be refrigerated can be loaded immediately after switching on, because the storage temperature in the refrigerator is quickly reached.
5. Set the freezer temperature to  $-18\text{ }^{\circ}\text{C}$  or colder (see section: "Temperature Adjustment").
- i** Do not load freezer with goods until a temperature of  $-18\text{ }^{\circ}\text{C}$  has been reached, or until the red warning indicator light has gone out.

# Temperature Adjustment

With the individual temperature setting buttons the desired temperatures in the refrigerator and in the freezer compartment can be adjusted independently of one another.

-  1. Press either the „+“ (WARMER) or „-“ (COLDER) button.  
The temperature display switches over and the DESIRED temperature currently set flashes on the temperature display.
2. To adjust to a warmer temperature, press the „+“ (WARMER) button. To adjust to a colder temperature, press the „-“ (COLDER) button. The changed setting is immediately displayed on the temperature display. Each time the button is pressed the temperature is adjusted by 1 °C.

Adjustable temperature range for the freezer compartment:  
-15 °C to -24 °C.

Adjustable temperature range for the refrigerator compartment:  
+2 °C to +8 °C, +15 °C (Holiday mode)

 **Note:** From a food science point of view, +5 °C for the refrigerator compartment and -18 °C for the freezer compartment should be considered cold enough as a storage temperature.

3. Once the required temperature has been set, after a short period (approx. 5 sec.) the temperature display will change and again indicate the current ACTUAL temperature inside the fridge or freezer compartment. The display changes from flashing to illuminated numbers.

**Important!** Please check the red warning display and temperature display regularly to assure maintenance of the storage temperature.

# COOLMATIC/FROSTMATIC

## COOLMATIC



The COOLMATIC function is suited for quick cooling of large quantities of goods in the refrigerator, e.g. drinks and salads for a party or wedding.

1. The COOLMATIC function is switched on by pressing the COOLMATIC button. The yellow light illuminates. The COOLMATIC function now gives intensive cooling. A DESIRED temperature of +2 °C is automatically selected. The COOLMATIC function is ended automatically after a period of 6 hours. The appliance will then return to the originally selected DESIRED temperature. The temperature display shows the ACTUAL refrigerator temperature.
2. The COOLMATIC function can be ended manually at any time by pressing the COOLMATIC button again. The yellow light goes out.

## FROSTMATIC





The FROSTMATIC function provides for quick freezing of fresh food products, and at the same time protects previously stored goods against undesired warming in the freezer compartment.

1. The FROSTMATIC function is switched on by pressing the FROSTMATIC button. The yellow light illuminates.
2. The FROSTMATIC function can be ended manually at any time by pressing the FROSTMATIC button again. The yellow light goes out. If the FROSTMATIC function is not ended manually, the appliance electronics switch off the FROSTMATIC function after approx. 50 hours. The yellow light goes out.





# Switching the Appliance Off

 The refrigerator compartment can be switched off independently of the freezer compartment.

-  1. To switch off the appliance, hold down the ON/OFF button. This will result in a countdown from "3" to "1" taking place in the temperature displays. On reaching "1" the fridge and freezer compartment will switch off. The temperature displays and the mains power light will go off.

## Switching off the refrigerator only:

-  1. To switch off the refrigerator, hold down the "+" button for the refrigerator until „OF" is shown in the temperature display. Then again press and hold down the "+" button. After a short time a countdown from "3" to "1" is taking place in the temperature display for the refrigerator. On reaching "1" the refrigerator will switch off. The temperature display will go off.

 The appliance is only completely disconnected from the electricity supply when the power plug has been removed from the power outlet.

## Note:

The appliance cannot be switched on or off if unplugged, or if there is no power being supplied to it.

Following connection to the mains power supply, the appliance returns to the same operating state as before the interruption of main power.

## If the appliance is not to be used for an extended period:

-  1. Switch appliance off by pressing and holding the ON/OFF button (see above).
2. Remove the mains plug or switch off.
  3. Defrost freezer compartment and clean the appliance thoroughly (see section: "Maintenance and Cleaning").
  4. Leave the doors open to avoid accumulation of odours.

## Holiday Mode

In the holiday mode the temperature for the refrigerator is approximately +15 °C. In the holiday mode it is therefore possible to leave the door of the empty refrigerator closed during periods of extended absence. Advantage: Unintentional closing of the door, or accidental closing of the door by persons who have access to your home during your absence, is no longer possible. Without the holiday mode leaving the door closed would lead to the accumulation of odours and mould.

After emptying and cleaning the appliance, proceed as follows:

1. To set the holiday mode, press the „+“ (WARMER) or „-“ (COLDER) button.

The temperature display will change and indicate in flashing numbers the DESIRED temperature that is currently set.

2. Press the „+“ (WARMER) button until the temperature display indicates H (for holiday). The temperature shown in the temperature display will change in steps of 1 °C until it reaches +8 °C. After +8 °C the value +15 °C will appear in the display with the letter H. The fridge is now operating in energy-saving holiday mode.

-  To switch the fridge back to normal operation, press the „-“ (COLDER) button.

**Important!** Do not store any goods in the refrigerator when the holiday mode is in operation. The temperature is regulated at about +15 °C when the holiday mode is in operation. This is too warm for food products.

# Control and Information Systems

The control and information systems consist of temperature displays, an optical warning display and an acoustic warning.

The system warns:

- when first switching on the appliance (when the storage temperature has not yet been attained);
- when the appliance doors are open
- if the temperature in the refrigerator or freezer compartment is too high;
- if there are functional faults with the appliance.

## "Open Door"-Warning

If the fridge or freezer door is left open the red warning display will flash and an acoustic warning tone will sound

- after approx. 80 seconds if the freezer door is left open
- after approx. 5 minutes if the fridge door is left open

If you need more time to load or rearrange refrigerated or frozen foods, you can switch off the warning tone by pressing the ALARM OFF button.

If the doors are still left open the warning tone will sound again at the end of the appropriate period of time.

If the doors remain open for longer than 80 minutes the warning tone will switch itself off automatically.

The red warning display will go off when the doors are closed.

## Temperature Warning

### For the fridge:

The red warning display flashes and a warning tone sounds as soon as the temperature in the fridge rises to more than +11 °C.

-  1. You can switch off the warning tone using the ALARM OFF button.



Both warning display and audible warning are automatically switched off, when the temperature in the fridge falls to lower than +12 °C. Besides this, the warning tone switches off automatically after 80 minutes have passed.

### For the freezer:

The red warning display flashes and a warning tone sounds as soon as the temperature in the freezer rises to more than  $-12\text{ }^{\circ}\text{C}$ . In addition the freezer temperature display flashes.

-  1. You can switch off the warning tone using the ALARM OFF button. The freezer temperature display stops flashing and displays the warmest temperature that has been reached in the freezer during the temperature alarm. After approx. 5 seconds the temperature display reverts to the current freezer temperature.



The warning tone switches off automatically

- if the temperature in the freezer falls to lower than  $-8\text{ }^{\circ}\text{C}$ . The red warning indicator light and the temperature display continue to flash.
- after 80 minutes have passed. The red warning display and the temperature display continue to flash.

If the possibility of partial or complete thawing exists, you should check the quality of the foods.

A rise in temperature may be caused by:

- frequent door opening for long periods of time;
- loading with large quantities of warm foods;
- high ambient temperature;
- an error with the appliance.

## Function Errors

If the electronics in the appliance detects a technical defect that has to be rectified by the customer, the temperature display indicates:

- a square or a letter in the temperature display of the fridge for a fault in the fridge,
- a square or a letter in the temperature display of the freezer for a fault in the freezer.

## Opening the Freezer Compartment Door

If the freezer compartment door is closed when the appliance is in operation, it is possible that it cannot be immediately opened again. A vacuum occurs in the freezer compartment which holds the door closed until pressure has been equalised. The door can be opened again after several minutes.

# Interior Accessories

## Storage Shelves

A storage shelf must be inserted into the lower guide track above the fruit and vegetable drawers. It must always remain in this position, so that fruits and vegetables remain fresh longer.

The remaining storage shelves can be adjusted to various heights:

1. Pull the storage shelf forward until it can be tipped up or down and removed.
2. To insert at a different height use the same procedure in reverse.

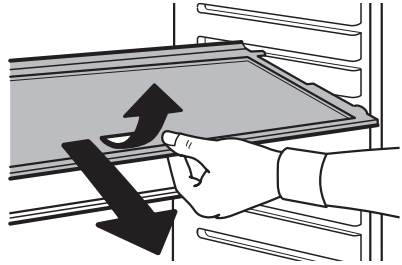

Adjustment for tall items:

1. Remove the front half of the two-part vario glass storage shelf and insert it at a different level. Space is then gained for storage of tall items on the storage shelf below.



## Variable Inner Door

The door compartments can be pulled up and removed, and inserted at other positions as needed.

## Bottle rack

Place bottles in the rack with the bottleneck to the front.

**Important:** Only store unopened bottles horizontally.

The bottle rack can be tilted for storing opened bottles.

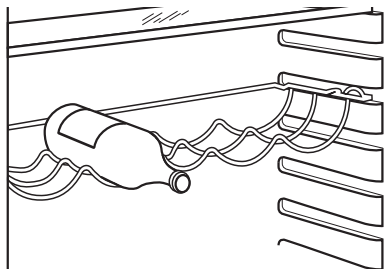

- 1. To do this pull the bottle rack forward until it can be tilted upwards, then slide the front support into the next level up.

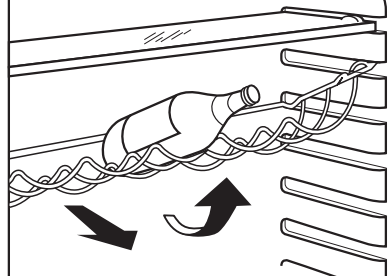

## Bottle Holder

Some models are equipped with a bottle holder in the bottle compartment. This is used to prevent individual bottles from falling over and can be slid sideways.

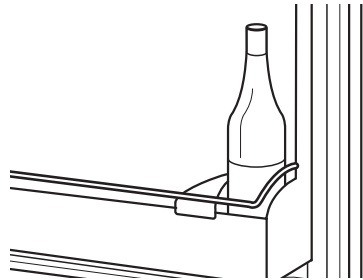

## Correct storage

For physical reasons, the refrigerator compartment has different temperature zones. The coldest zone is on the lowest storage shelf immediately above the salad bin. Warmer zones are the upper storage shelves and door racks. The arrangement (see fig.) indicates where different types of food are best stored to make the most of temperature variations.

For instance, the shelf immediately above the fruit and vegetable drawers should be 5 °C for safe storage of meat and fish products. In order to check that the appliance is at 5 °C on the lowest shelf you can carry out the following test yourself:

1. Place a cup of water in the centre of the said shelf with a thermometer inside.
2. Leave the fridge door closed overnight and check the temperature first thing in the morning.
3. At this point the temperature should read no more than 5 °C; if it does, you need to adjust the temperature regulator to a colder setting.

For further information on keeping food cool and safe a guide published by the Ministry of Agriculture, Fisheries and Food is available and can be obtained free of charge by contacting:

Foodsense, London SE99 7TT. Tel: 0645 556000

**Tip:** Food stored in the refrigerator compartment should always be covered or packed so that they do not dry out, lose their flavour, or transfer their flavour to any other refrigerated food. The following are suitable for packing:

- polyethylene bags;
- plastic containers with lids;
- special plastic covers with rubber retainers;
- aluminium foil.

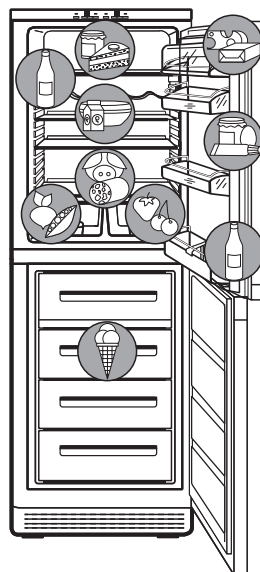



# Freezing

Except for the bottom drawer, which serves only for storage purposes, all compartments and drawers in the freezer compartment are suitable for freezing fresh food.

## Warning!

- Before foods are frozen, the actual temperature in the freezer compartment must be  $-18\text{ }^{\circ}\text{C}$  or colder.
- Please observe indicated freezing capacity on the rating plate. The freezing capacity represents the maximum amount of fresh goods that can be frozen within 24 hours. If you freeze goods on several days, one after the other, freeze amounts equal to  $2/3$  to  $3/4$  of the capacity indicated on the rating plate.
- When freezing large quantities of food, place the frozen accumulation block at the front into the top drawer in the freezing compartment.
- Thawed foods which have not been processed further (cooked into meals) may not under any circumstances be frozen a second time.

 1. For freezing the maximum capacity press the FROSTMATIC button 24 hours prior to freezing, or 4 to 6 hours for smaller quantities. Yellow indicator lights up.

 The FROSTMATIC button need not be pressed for freezing of small quantities of up to 3 kg.

2. All foods must be packed air tight prior to freezing, so that they do not dry out or lose their flavour, and so that no flavour contamination of other frozen goods occurs.

**Caution!** Do not touch frozen goods with wet hands. Hands can freeze to the goods.

3. Place packaged goods in the drawers. Unfrozen goods may not come into contact with already frozen goods, otherwise the frozen goods may start to thaw.

 The appliance electronics automatically switch the FROSTMATIC function off after a period of approx. 50 hours. The yellow indicator light goes out. You can also stop the FROSTMATIC function manually by pressing the FROSTMATIC button again.



### Tips:

- The following are suited for the packaging of frozen goods:
  - freezer bags and polyethylene wraps;
  - plastic containers for frozen foods;
  - extra-thick aluminium foil
- The following are suited for sealing bags and wraps:  
plastic clips, rubber bands or adhesive tape.
- Press air out of bags and wraps before sealing, because air encourages drying of frozen goods.
- Make flat packages, because these freeze more quickly.
- Do not fill plastic containers for frozen foods to the brim with liquid or paste-like goods, because liquids expand during freezing.

## Frozen Storage

**Warning!** Before initial loading of the freezer compartment with previously frozen goods, the required storage temperature of  $-18\text{ }^{\circ}\text{C}$  must be reached.

- Load freezer only with packaged frozen goods, so that they do not dry out or lose their flavour, and so that no flavour contamination of other frozen goods can occur.
- Please observe maximum storage times and expiry dates of frozen goods.



When possible store frozen goods separately according to type in drawers.

## Storage Goods Symbols/Freezing Calendar

- The symbols on the drawers show different types of frozen goods.



- The numbers indicate storage times in months for the appropriate types of frozen goods. Whether the upper or lower value of the indicated storage time is valid depends on the quality of the foods and pre-treating before freezing. The lower value applies to foods with high fat content.

# Preparation of Ice Cubes

-  1. Fill ice cube tray 3/4 full with cold water and place in a drawer and allow to freeze.
2. To remove the finished ice cubes twist the ice cube tray or hold under running water for a short time.  
**Warning!** Do not, under any circumstances, free an ice tray which is frozen to the appliance with pointed or sharp edged objects. Use a spoon-handle or similar object.

## Defrosting

### The refrigerator is defrosted automatically

The electronics start the defrosting cycle in the refrigerator every time the compressor stops.

The water collects in the discharge trough at the back wall of the refrigerator, and is fed through the discharge opening in the catch tray at the compressor where it is evaporated.

### Freezer Compartment Defrosting

Moisture is precipitated in the form of white frost in the freezer compartment during operation and when the door is opened, especially in the middle at the top. Remove this white frost from time to time with a soft plastic scraper, e.g. a dough scraper. Do not under any circumstances use hard or pointed objects for this purpose.

The appliance should be defrosted when the thickness of the white frost has reached about 4 mm; but at least once a year in any case. A convenient time for defrosting is any time when the appliance is empty, or only minimally loaded.



#### Warning!

- Do not use electrical heating appliances or any other mechanical or artificial devices to speed up the defrosting process, with the exception of those recommended in these operating instructions.
- Do not use defrosting sprays, because they may be health endangering and/or contain substances damaging to plastics.

-  1. About 12 hours prior to defrosting push the FROSTMATIC button, in order to build up sufficient chill reserve for the interruption in operation.

**Caution!** Do not touch frozen goods with wet hands. Hands can freeze to the goods.

2. Remove frozen goods, pack them in several layers of newspaper, cover them and store them in a cool place.
3. Switch off the appliance and remove plug from the mains, or disconnect from the electricity supply.
4. Remove all the drawers. Remove the plinth (see "Reversing the Door" section). Place the bottom drawer directly in front of the appliance to collect the water from defrosting and pull out the water drain conduit.

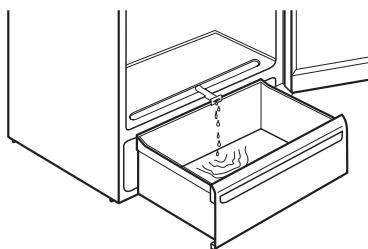

**Tip:** In order to speed up the defrosting process, place a pot of hot water in the freezer compartment. In addition, remove pieces of ice that break away before defrosting is complete.

5. After defrosting thoroughly clean the freezer interior, as well as interior accessories (see section: "Maintenance and Cleaning").

## Hints and Tips

### Normal Operating Sounds

- You may hear faint gurgling or bubbling sounds when the refrigerant is pumped through the coils or tubing at the rear, to the cooling plate/evaporator.
- When the compressor is on, the refrigerant is being pumped round and you will hear a whirring sound or pulsating noise from the compressor.
- A thermostat controls the compressor and you will hear a faint click when the thermostat cuts in and out.

### Food Storage

To obtain the best performance from your refrigerator/freezer:

- Do not store warm food or evaporating liquids.
- Do not store food uncovered.

- Keep the time between buying chilled food and placing it in your freezer as short as possible.
- Do not push food together too much, try to allow air to circulate around each item.



## Energy Saving Advice

- Do not install the appliance close to sources of heat, such as a cooker, dishwasher or radiator.
- Locate the appliance in a cool well ventilated room and make sure that the air openings of the appliance are not obstructed.
- Always leave warm food to cool down to room temperature before placing in the freezer compartment.
- Try to avoid keeping the door open for long periods or opening the door too frequently as warm air will enter the cabinet and cause the compressor to switch on unnecessarily often.
- Ensure there are no obstructions preventing the door from closing properly.

## Maintenance and Cleaning

Before any maintenance or cleaning work is carried out **DISCONNECT** the appliance from the **ELECTRICITY** supply.



### Warning!

- Do not use detergents, abrasive powders, highly perfumed cleaning products, wax polishes or cleaning products containing bleach or alcohol.
- Never clean the appliance with a steam cleaner. Moisture could accumulate in electrical components, danger of electrical shock! Hot vapours can lead to the damage of plastic parts.
- The appliance must be dry before it is placed back into service.

### Attention!

- Ethereal oils and organic solvents can attack plastic parts, e. g.
  - lemon juice or the juice from orange peels;
  - butyric acid;
  - cleansers which contain acetic acid.
 Do not allow such substances to come into contact with appliance parts.
- Do not use any abrasive products.

## Internal Cleaning

 If the refrigerator only is to be cleaned, press the FROSTMATIC button several hours in advance, in order to build up sufficient chill reserve in the freezer compartment for the interruption in service. Do not open the freezer compartment door.

 1. Press the FROSTMATIC button several hours in advance, in order to build up sufficient chill reserve in the frozen food for the interruption in service.

**Caution!** Do not touch frozen goods with wet hands. Hands can freeze to the goods.

2. Remove chilled and frozen food, wrap it in several layers of newspaper and store it, covered, in a cool place. Place the cold accumulation block on top of the frozen food to keep it cold.

3. Switch off the appliance and remove plug from the mains, or disconnect from the electricity supply.

4. Defrost the freezer compartment (see section: "Defrosting").

5. Clean the inside and accessories with warm water and bicarbonate of soda (5 ml to 0.5 litre of water).

6. Rinse and dry thoroughly.

7. Regularly check the door seals and wipe clean to ensure they are clean and free from debris.

8. Regularly unblock the condensation water drainage hole in the rear wall of the refrigeration chamber with the aid of a piece of wire.

## External Cleaning



### Warning!

- There are sharp edges on the underside of the product so care should be taken when cleaning.
- Do not use abrasive products

 1. Wash the outer cabinet with warm soapy water.

2. Rinse and dry thoroughly.

 Use a normal household stainless steel cleaner to clean the stainless steel surface.

This cleaner simultaneously forms a protective film against finger marks.

 **Caution:** Do not allow the stainless steel cleaner to come into contact with plastic parts, e.g. the end caps on the doors, as it will damage them.

 Accumulation of dust at the condenser increases energy consumption. For this reason carefully clean the condenser at the back of the appliance once a year with a soft brush or a vacuum cleaner.

3. After everything is dry place appliance back into service.

## Replacing the light bulb

 For safety reasons the interior lighting switches off after 7 minutes when the door is open. It switches on again the next time the door is opened.

 **Warning!** Danger of electrical shock! Before replacing the light bulb switch off the appliance and remove the mains plug.

Light bulb specifications: 220-240 V, max. 25 W, fitting: E 14

-  1. To switch the appliance off press and hold the ON/OFF button.
2. Unplug the mains plug.
3. To change the light bulb, undo the cross head screw and remove the light bulb cover downwards.
4. Change the defective light bulb.
5. Refit the light bulb cover and the cross head screw.

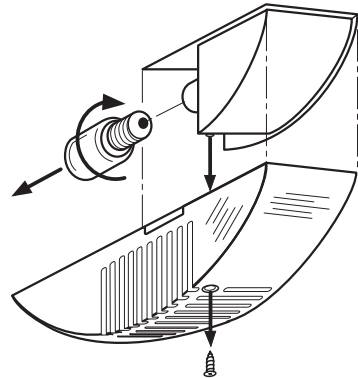

## What to do if .....

Before contacting your local Service Force Centre, check the following points.

Symptom	Solution
No power to the appliance.	Check there is power at the socket
	Check there is not a power cut by checking the household lights.
	Check the fuse has not blown.
Appliance cools too much.	Temperature is set too cold. Temporarily select a higher temperature setting.
The temperature in the refrigerator/ freezer is too high.	Check the ambient temperature is within the appliances operating limits
	Check the temperature setting is correct relative to ambient conditions.
Temperature display shows a square or a letter.	There is a function fault. Please contact your local Service Force Centre. Do not open the door of the appliance again.
Warning tone sounds, red warning display is flashing.	"Open door" warning. Please check in "Control and Information System" section.
Warning tone sounds, red warning display and freezer temperature display are flashing.	Temperature warning for freezer. Please check in "Control and Information System" section.
Water on the floor or on the storage shelf	Water drain hole is blocked, see "Maintenance and Cleaning".
Interior illumination does not function. Important: The interior lighting switches off automatically after 7 minutes.	Please refer to "Replace Light Bulb " section.

Symptom	Solution
Excessive build up of frost.	If the door seal is not airtight (probably after reversing the door) apply warm air to the non sealing area using a hair dryer set to a gentle heat. (do not use a fan heater for this purpose). This will make the rubber more supple and allow it to revert to its original shape.
The compressor runs continuously	Adjust the temperature to give correct temperature control.
	Check that the doors are closed.
	Large quantities of food have recently been placed in the cabinet and/or door is frequently opened.
	Check that air ventilation is not obstructed.
Noise	Refer to Normal Operating Sounds
The compressor does not start immediately after changing the temperature setting.	This is normal, the compressor starts after a period of time.

If after the above checks there is still a fault, call your local AEG Service Force Centre.

In-guarantee customers should ensure that the above checks have been made as the engineer will make a charge if the fault is not a mechanical or electrical breakdown.

Please note that proof of purchase is required for in-guarantee service calls.

## Regulations, Standards, Guidelines

This appliance was designed for household use and was manufactured in accordance with the appropriate standards. The necessary measures in accordance with appliance safety legislation regulations (GSG), accident prevention regulations for refrigeration appliances (VBG 20) and the regulations of the German Society of Electrical Engineers (VDE) were observed in the manufacture of this appliance. The refrigerant circuit has been checked for leaks.



- CE** This appliance is in accordance with the following EU guidelines:
- 73/23/EEG dated 19 February 1973 - low voltage guidelines.
  - 89/336/EEG dated 3 May 1989  
(including guideline change notice 92/31/EEG) - EMV guideline

## Technical Terminology

- **Refrigerant**

Liquids that can be used to generate a cooling effect are known as refrigerants. They have a relatively low boiling-point, indeed so low, that the warmth from the food stored in the fridge or freezer can cause the refrigerant to boil and vaporise.

- **Refrigerant Circuit**

Closed circulation system that contains the refrigerant. The refrigerant circuit comprises primarily of an evaporator, a compressor, a condenser and pipe work.

- **Evaporator**

The refrigerant is evaporated in the evaporator. Similar to all other liquids, refrigerant requires heat to evaporate. This heat is removed from the interior of the appliance, as a result the interior is cooled. The evaporator is therefore located inside the appliance or placed in foam immediately behind the inner wall and thus not visible.

- **Compressor**

The compressor looks like a small drum. It is driven by a built-in electric motor and is mounted on the base of the appliance at the rear. The task of the compressor is to draw in vaporised refrigerant from the evaporator, to compress it, and to pass it on to the condenser.

- **Condenser**

The condenser normally has the form of a grid. The refrigerant compressed in the compressor is liquefied in the condenser. During this process, heat is released to the surrounding air at the surface of the condenser. The condenser is mounted on the base of the appliance.

# Guarantee Conditions

## Standard Guarantee Conditions

We, AEG, undertake that if within 12 months of the date of the purchase this AEG appliance or any part thereof is proved to be defective by reason only of faulty workmanship or materials, we will, at our discretion repair or replace the same FREE OF CHARGE for labour, materials or carriage on condition that:

- The appliance has been correctly installed and used only on the electricity or gas supply stated on the rating plate.
- The appliance has been used for normal domestic purposes only, and in accordance with the manufacturer's operating and maintenance instructions.
- The appliance has not been serviced, maintained, repaired, taken apart or tampered with by any person not authorised by us.
- All service work under this guarantee must be undertaken by a Service Force Centre. Any appliance or defective part replaced shall become the Company's property.
- This guarantee is in addition to your statutory and other legal rights.
- Home visits are made between 8.30am and 5.30pm Monday to Friday. Visits may be available outside these hours in which case a premium will be charged.

## Exclusions

This guarantee does not cover:

- Damage or calls resulting from transportation, improper use or neglect, the replacement of any light bulbs or removable parts of glass or plastic.
- Costs incurred for calls to put right an appliance which is improperly installed or calls to appliances outside the United Kingdom.
- Appliances found to be in use within a commercial environment, plus those which are subject to rental agreements.
- Products of AEG manufacture which are not marketed by AEG.

## European Guarantee

If you should move to another country within Europe then your guarantee moves with you to your new home subject to the following qualifications:

- The guarantee starts from the date you first purchased your product.
- The guarantee is for the same period and to the same extent for labour and parts as exists in the new country of use for this brand or range of products.
- This guarantee relates to you and cannot be transferred to another user.
- Your new home is within the European Community (EC) or European Free Trade Area.
- The product is installed and used in accordance with our instructions and is only used domestically, i.e. a normal household.
- The product is installed taking into account regulations in your new country.

Before you move please contact your nearest Customer Care centre, listed below, to give them details of your new home. They will then ensure that the local Service Organisation is aware of your move and able to look after you and your appliances..

France	Senlis	+33 (0) 3 44 62 29 29
Germany	Nürnberg	+49 (0) 800 234 7378
Italy	Pordenone	+39 (0) 800 117511
Sweden	Stockholm	+46 (0) 8 672 5360
UK	Slough	+44 (0) 1753 219899

# Service & Spare Parts

In the event of your appliance requiring service, or if you wish to purchase spare parts, please contact Service Force by telephoning:

**08705 929 929**

Your telephone call will be automatically routed to the Service Force Centre covering your post code area.

For the address of your local Service Force Centre and further information about Service Force, please visit the website at [www.serviceforce.co.uk](http://www.serviceforce.co.uk)

Before calling out an engineer, please ensure you have read the details under the heading „What to do if....“

When you contact the Service Force Centre you will need to give the following details:

1. Your name, address and post code.
2. Your telephone number
3. Clear and concise details of the fault.
4. The model and serial number of the appliance (found on the rating plate).

• Model Name



• Model Number (PNC)



• Serial Number (S-No.)



5. The purchase date

Please note that a valid purchase receipt or guarantee documentation is required for in-guarantee service calls.

## Customer Care

For general enquiries concerning your AEG appliance or for further information on AEG products please contact our Customer Care Department by letter or telephone at the address below or visit our website at [www.aeg.co.uk](http://www.aeg.co.uk).

Customer Care Department  
AEG Domestic Appliances  
55-77 High Street  
Slough  
Berkshire, SL1 1DZ

Tel. 08705 350350 (\*)

(\*) Calls may be recorded for training purposes

 **From the Electrolux Group. The world's No. 1 choice.**

*The Electrolux Group is the world's largest producer of powered appliances for kitchen, cleaning and outdoor use. More than 55 million Electrolux Group products (such as refrigerators, cookers, washing machines, vacuum cleaners, chain saws and lawn mowers) are sold each year to a value of approx. USD 14 billion in more than 150 countries around the world.*

AEG Hausgeräte GmbH  
Postfach 1036  
D-90327 Nürnberg

<http://www.aeg.hausgeraete.de>

© Copyright by AEG

818 3480 – 00/6 – 0404

Subject to change without notice

**This file has been downloaded from:**

[www.UsersManualGuide.com](http://www.UsersManualGuide.com)

User Manual and User Guide for many equipments like mobile phones, photo cameras, mother board, monitors, software, tv, dvd, and othes..

Manual users, user manuals, user guide manual, owners manual, instruction manual, manual owner, manual owner's, manual guide, manual operation, operating manual, user's manual, operating instructions, manual operators, manual operator, manual product, documentation manual, user maintenance, brochure, user reference, pdf manual