

# ZANUSSI

 Electrolux

## WASHING MACHINE

### ZWF 1237 W

### ZWF 1437 W

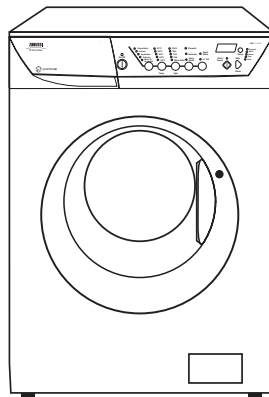

 Quick Installation Guide:

visit our WEB SITE to view an install video

[www.video.uk.electrolux.com](http://www.video.uk.electrolux.com)



# Important Safety Information

It is most important that this instruction book should be retained with the appliance for future reference. Should the appliance be sold or transferred to another owner, or should you move house and leave the appliance, always ensure that the book is supplied with the appliance in order that the new owner can get to know the functioning of the appliance and the relevant warnings.

These warnings have been provided in the interest of safety. You **MUST** read them carefully before installing or using the appliance.

## Installation

- This appliance is heavy. Care should be taken when moving it.
- It is dangerous to alter the specifications or attempt to modify this product in any way.
- All packing and transit bolts must be removed before use. Serious damage can occur to the product and to property if this is not adhered to. See relevant section in instructions.
- Any plumbing work required to install this appliance should be carried out by a qualified plumber or competent person.
- Any electrical work required to install this appliance should be carried out by a qualified electrician or competent person.
- Care must be taken to ensure that the appliance does not stand on the electrical supply cable.
- If the machine is situated on a carpeted floor, please adjust the feet in order to allow air to circulate freely.
- Do not overload the appliance. See relevant section in the instruction book.
- Only wash fabrics which are designed to be machine washed. If in doubt, consult the care label on the clothes.
- Before washing, ensure that all pockets are empty and buttons and zips are fastened. Avoid washing frayed or torn articles and treat stains such as paint, ink, rust, and grass before washing. Underwired bras must NOT be machine washed.
- Any objects such as coins, safety pins, nails, screws, stones or any other hard, sharp material can cause extensive damage and must not be placed into the machine.
- Garments which have been in contact with volatile petroleum products should not be machine washed. If volatile cleaning fluids are used, care should be taken to ensure that the fluid is removed from the garment before placing in the machine.
- Wash small items such as socks, laces, washable belts etc in a washing bag or pillow case as it is possible for such items to slip down between the tub and the inner drum.

## Child Safety

- This appliance is designed to be operated by adults. Children should not be allowed to tamper with the controls or play with the product.
- Pets and children have been known to climb into washing machines. Please check your drum before use.
- The glass door becomes very hot during the washing cycle. Keep children away from the vicinity of the appliance whilst it is in operation.
- Keep all packaging well away from children.
- Keep all detergents in a safe place out of children's reach.
- Only use the advised quantities of fabric softener. Damage to the fabric can ensue if you over-fill. Refer to the manufacturer's recommendations of quantities.
- As some duvets and eiderdowns should be washed in large commercial machines because of their bulk, please check with the manufacturer of the item before washing in a domestic machine.
- Leave the porthole door slightly ajar between washes to preserve the door seal.
- Under no circumstances should you attempt to repair the machine yourself. Repairs carried out by inexperienced persons may cause injury or serious malfunctioning. Contact your local Service Force Centre. Always insist on genuine spare parts.

## Use

- Always unplug the appliance and turn off the water supply after use.

# Contents

## For the User

<b>Important Safety Information</b>	2
<b>Your New Washing Machine</b>	4
<b>Description of the Appliance</b>	5
Door locked light	5
Detergent dispenser drawer	5
Child safety feature	5
<b>The Control Panel</b>	6-10
Turning the acoustic signal off	6
<b>Operating Sequence</b>	11-13
Load the laundry	11
Measure out the detergent	11
Measure out the fabric softener	11
Switch the machine on	11
Select the required programme/fabric	11
Select the temperature	11-12
Select the spin speed or the Rinse Hold option	12
Select the desired options	12
Select the Super Rinse or 40°AA option	12
Select the Delay Start	12
Start the programme	12
How to change an option or a programme during its cycle	13
How to cancel a programme during its cycle	13
How to open the door during the cycle of a programme	13
End of programme	13
<b>Washing Hints</b>	14-15
Which detergent?....	15
And in which form?	15



<b>Wash Care Symbols</b>	16
<b>Washing Programmes</b>	17
<b>Maintenance and Cleaning</b>	18-19
Descaling	18
After each wash	18
Maintenance Wash	18
External cleaning	18
Cleaning the dispenser drawer	18
Cleaning the drawer recess	18
Cleaning the pump	18-19
Cleaning the water inlet filter	19
The dangers of freezing	19
Emergency emptying out	19
<b>Something Not Working</b>	20-21
<b>Service and Spare Parts</b>	21-22
<b>Guarantee Conditions</b>	22

## For the Installer

<b>Installation Instructions</b>	23
<b>Technical Specifications</b>	23
Unpacking	24
Positioning	24
Water inlet	25
Water drainage	25-26
Levelling	26
Special conditions	26
In the interest of the environment	26-27
Electrical connection	27

## Guide to use the Instruction Book

The following symbols will be found in the text to guide you throughout the instructions:

-  **Safety instructions**
-  **Hints and tips**
-  **Environmental information**

# Your New Washing Machine

Your new washing machine, which is fitted with the New Jet System, meets all modern requirements for effective treatment of laundry with low water, energy and detergent consumption.

Even small loads are washed “economically” because the amount of water used is regulated automatically according to the load and type of fabric.

- **Automatic cooling of the wash water to 60°C** before draining, with the 95°C programme. This reduces thermal shock to fabrics, helping to prevent creasing.
- **The special wool programme** with its new delicate wash system treats your woollens with extreme care.
- **The programme progress display** shows the different washing phases.
- **The balance control device** ensures that the washing machine remains stable when spinning.

## Ecological hints

To save water and energy and help protect the environment, we recommend that you follow these hints:

- Normally soiled laundry may be washed without prewashing in order to save detergent, water and time (the environment is protected too!).
- The machine works more economically if it is fully loaded.
- With adequate pre-treatment, stains and limited soiling can be removed; the laundry can then be washed at a lower temperature.
- Measure out detergent according to the water hardness, the degree of soiling and the quantity of laundry being washed.

## In the interest of the environment

- Materials marked with the symbol  are recyclable.
- Check with your local Council or Environmental Health Office to see if there are facilities in your area for re-cycling this appliance.
- When the appliance is to be scrapped, cut off the power supply cable and make the door lock device unusable to prevent young children from being trapped inside.
- Help to keep your country tidy - use authorised disposal sites for your old appliance.

The symbol  on the product or on its packaging indicates that this product may not be treated as household waste. Instead it shall be handed over to the applicable collection point for the recycling of electrical and electronic equipment. By ensuring this product is disposed of correctly, you will help prevent potential negative consequences for the environment and human health, which could otherwise be caused by inappropriate waste handling of this product. For more detailed information about recycling of this product, please contact your local city office, your household waste disposal service or the shop where you purchased the product.

**How do we help to protect the environment?  
We use recycled paper!**

## Important

Your machine is fitted with a balance control device, which ensures the machine is stable during the spin. If the wash load appears not to have been spun sufficiently at the end of the wash cycle, because it is not evenly distributed in the drum, the balance control device may have operated. It will therefore be necessary to redistribute the wash load manually and select a spin programme. For more detailed information see the section headed “Something Not Working”.

# Description of the Appliance

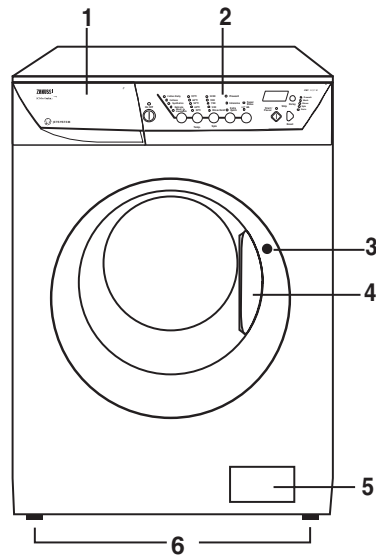

- 1 Detergent dispenser drawer
- 2 Control panel
- 3 Door locked light
- 4 Door opening handle
- 5 Drain pump
- 6 Adjustable feet



## Door locked pilot light

It stays on during the whole programme indicating that the door is locked.  
When the light goes out, the door can be opened.

## Detergent dispenser drawer

-  Prewash
-  Main wash
-  Fabric softener

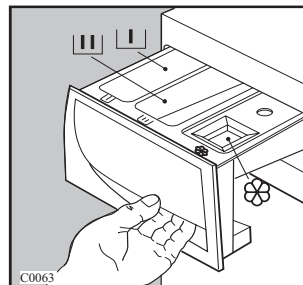

## Child safety feature

This machine incorporates a special child safety feature to prevent small children from being trapped inside the machine.

To activate this device, rotate the button (without pressing it) inside the door clockwise until the groove is horizontal. If necessary use a coin.

To disable this device and restore the possibility of closing the door, rotate the button anti-clockwise until the groove is vertical.

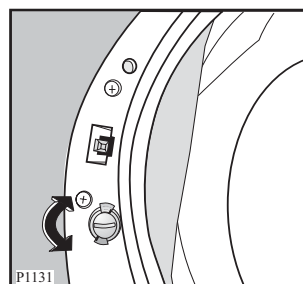

# The Control Panel

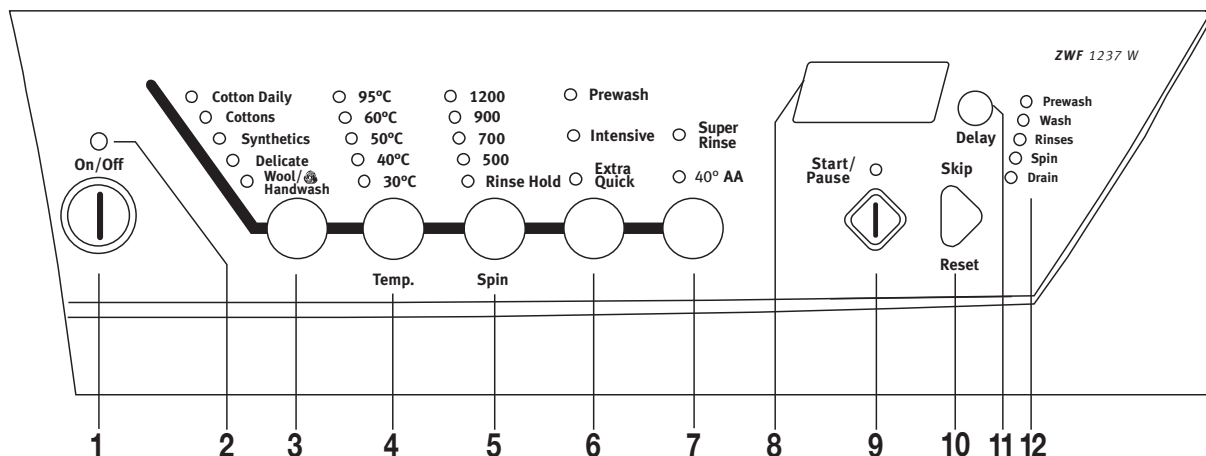

## 1 “On/Off” button

Press this button to switch the washing machine on. The display (8) will show three flashing dashes or a flashing zero. You will find more detailed explanations on pages 7-8 (see “Display”). Press the “On/Off” button again to switch the machine off.

## 2 MAINS-ON light

This light is connected to the “On/Off” button. It lights up when you press the button, and goes out when you press it again.

## 3 FABRICS button

Press this button repeatedly to select the programme on the basis of the type of laundry to be washed. The light relevant to the selected programme will light up. The machine will propose a temperature and automatically select the maximum spin value provided for the programme you have chosen. You can change these values by operating buttons 4 and 5.

### Cotton daily

To be used for lightly soiled **cotton items** in order to obtain a good washing performance in a **short time**.

### Wool / Handwash

When you select this programme, you obtain a particularly delicate wash, suitable for articles of clothing whose label indicates that they must be hand-washed .

## 4 “Temp.” button

Press this button repeatedly to increase or decrease the temperature, if you want your laundry to be washed at a temperature different from the one proposed by the washing machine. The relevant light will light up. Maximum temperatures are 95°C for Cottons and “Cotton daily” programme, 60°C for Synthetics, 40°C for delicate fabrics, Wool and fabrics to be hand-washed (**Wool**  / **Handwash** programme).

### IMPORTANT!

By pressing the “Temp.” and “Spin” buttons simultaneously for about 3 seconds, the acoustic signal is deactivated at the end of the cycle, when selecting the programmes and in case of an incorrect option selection. By pressing these 2 buttons again the acoustic signal is reactivated.

## 6 “Spin” button

Press this button repeatedly to change the spin speed, if you want your laundry to be spun at a speed different from the one proposed by the washing machine. The relevant light will light up.

Maximum speeds are:

- for cotton: 1,400 rpm (ZWF 1437 W)  
1,200 rpm (ZWF 1237 W);
- for synthetic fabrics, wool and fabrics to be hand-washed: 900 rpm;
- for delicate fabrics: 700 rpm.

- **“Rinse Hold”** position:

when you choose this option, the machine will not drain the water of the last rinse, so as not to crease the laundry.

At the end of the cycle, the door is locked, the **“Start/Pause”** button light goes out, the **“Rinse Hold”** button light remains lit, to indicate that the water must be drained and a flashing zero will appear on the display (the door locked light is on).

To complete the cycle, press **“Skip Reset”** button once, so as to cause all the lights to go off, the display will show three flashing dashes.

Then press FABRIC button in order to select the desired programme. If you wish to **drain or spin** press the **“Skip Reset”** button until the led of the **“Spin”** or **“Drain”** position on the programme progress display illuminates.

You can change the spin speed by means of **“Spin”** button and then depress **“Start/Pause”** button.

### Important!

If you accidentally press the **“Skip Reset”** button more than once, the display will show three flashing dashes. To drain the water, select any washing programme by means of the FABRICS button, then press **“Skip Reset”** three times in order to select the drain (only the **“Drain”** light will remain lit), then press again the **“Start/Pause”** button.

## 6 WASH CHOICE button

Press this button to select the following options:

- **Prewash:** select this option if you wish your laundry to be prewashed at 30° C before the main wash (**not available for Wool/Handwash programme**). The prewash ends with a short spin at 650 rpm in programmes for cotton and synthetic fabrics, whereas in the programme for delicate fabrics the water is only drained.
- **Intensive:** this option can be selected for heavily soiled laundry. If you depress this button the washing intensity will be increased and the washing time will be prolonged by few minutes depending on the selected type of fabric. This option can be selected with all **cottons** and **synthetic** programmes except for **Cotton Daily** programme.

- **Extra Quick:** select this option for laundry that is only slightly soiled because this is a very short washing cycle (**not available for Cottons Daily and Wool/Handwash programmes**).

The washing time will be reduced according to the type of fabric and the selected temperature.

The **Prewash**, the **Intensive** and the **Extra Quick** options **cannot** be selected together by means of the same button.

## 7 OPTIONS button

Press this button to select the following options:

- **Super Rinse:** this option can be selected with all programmes **except the Wool/Handwash programme**. The machine will add 2 rinses to the cotton programmes and 1 rinse to the synthetic and delicate programmes. This option is recommended for people who are allergic to detergents, and in areas where the water is very soft.
- **40° AA:** this option **can** be selected for **cottons** and **synthetics** lightly or normally soiled with a temperature of 40°C or higher. The washing temperature will be reduced and the washing time will be prolonged in order to achieve an AA class in energy efficiency and washing performance (**not available for Cottons Daily programme and in combination with “Intensive” or “Extra Quick” option**).

The **Super Rinse** and the **40° AA** options **cannot** be selected together by means of the relevant button.

## 8 Display

The following pieces of information are shown on the display:

- **Three flashing dashes**, when a programme is cancelled by means of the **“Skip Reset”** button.

The three flashing dashes will also appear when you press the **“On/Off”** button to switch the machine on, if the previously selected cycle has been erased.

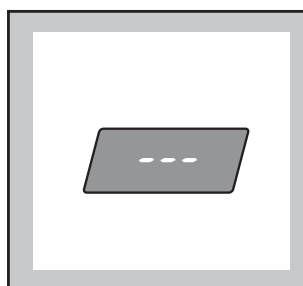



- **Duration of washing programme** in hours and minutes, after you have selected a programme.



While the programme is running (after you have pressed the “**Start/Pause**” button), the displayed time value decreases by one unit every minute.

- **The washing machine has stopped with water in the tub**, at the end of a programme with the “**Rinse Hold**” option: this is indicated by a **flashing zero**.
- **The washing machine has completed the programme**: this is indicated by a **flashing zero**. The zero will reappear when you switch the washing machine on, unless the previous programme has been erased by means of the “**Skip Reset**” button.

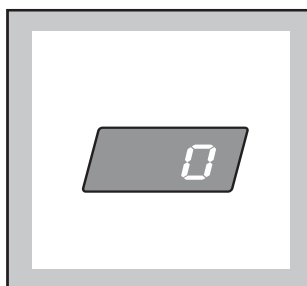

### Important!

**The first time you use the washing machine**, when you switch it on, it may display a flashing zero and give an audible warning signal. This is due to the fact that the washing machine has performed a washing cycle during the manufacturer’s inspection tests, and this cycle has not been erased after its completion.

- **Delay start**, a time value indicated in hours and selected by means of the relevant button (max 23 hours).



The delay time is displayed for 3 seconds, then the duration of the selected programme reappears. After you have pressed the “**Start/Pause**” button, the countdown begins, and the delay time value decreases by one unit every hour and then, when 2 hours remain, the time decreases in 30 minute intervals. You can delay the start of the selected programme by up to 23 hours in one hour intervals.

- **An incorrect option selection has been made**: this is indicated by the message **Err** when a function incompatible with the current programme is selected.

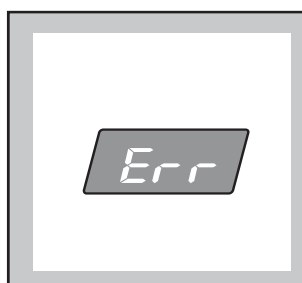

The incorrect selection is also indicated by an audible warning signal.

- **An alarm code** indicates a fault in the machine operation (see the relevant chapter on page 20).





## 9 “Start/Pause” button

This button has two functions:

- **Start:** after you have selected the desired programme and options, press this button to start the washing machine. The light above the button will stop flashing and remain lit.

If you have selected a delay time by means of the “Delay” button, the countdown will begin and will be shown on the display.

- **Pause:** when you press this button again, the programme in progress is interrupted. The light above the button will start flashing. To restart the programme, press the button again.

When you PAUSE the cycle, and it becomes possible to open the door, provided

- the washing machine is not in the heating phase;
- the level of the water is not high;
- the drum is not turning.

### Important!

You must set the washing machine to Pause before you make any change in the programme in progress.

## 10 “Skip/Reset” button

This button performs two functions:

- Clears the memory
- Selects special programmes

At the end of every programme the Reset button must be pressed once or repeatedly to clear the programme memory. This will be confirmed by three dashes, flashing in the display.

If the previous programme is not cleared, the display will show a “D” flashing and an audible signal will sound, when you switch the machine on.

### Selecting a special programme:

A wash programme must be selected in the normal way. (“Start/Pause” button not pressed)

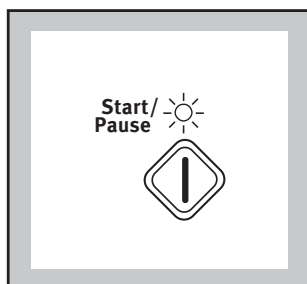

The “Skip” button is then used to cancel or advance the programme to the required phase.

The “Skip” button can only operate during the selection of the programmes or when the programme is in pause.

A normal wash cycle consists of the following phases, **Wash - Rinses - Spin** and is confirmed by the illumination of the corresponding LED,s.

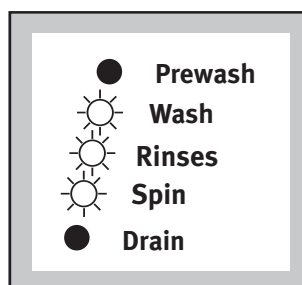

To select **rinses & spin**, press the “Skip” button once, the **wash** LED goes out.

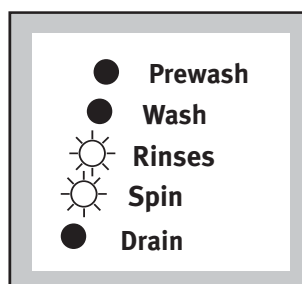

To select **spin** only, press the “Skip” button twice. The **wash & rinses** LED,s go out.

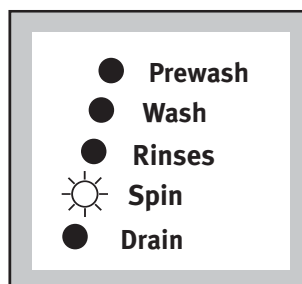

To select **Drain** only, press the “**Skip**” button three times, the **wash - rinses - spin** LED,s go out. The **Drain** LED only remains alight.

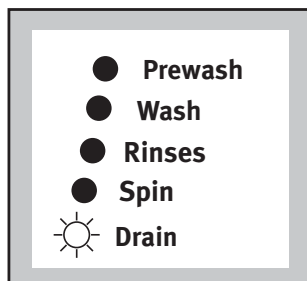

## 11 “Delay” button

This button makes it possible to delay the starting of the programme selected from 30 min - 60 min - 90 min, 2 hours and then by 1 hour up to a maximum of 23 hours. The delay you have selected is shown on the display for about 3 seconds; afterwards, the duration of the programme reappears.

You must select this option **after** you have set the programme and **before** you press the “**Start/Pause**” button.

The time value shown on the display will decrease by one unit every hour.

**You can change the delay time at any moment,** before you press the **Start/Pause** button.

If you have already pressed the Start/Pause button, and you wish to **cancel** the delay time, proceed as follows:

- set the washing machine to Pause by pressing the “**Start/Pause**” button;
- press the “**Delay**” button until the display shows the symbole «E'».
- press the “**Start/Pause**” button again.

### **Important!**

The door will be locked throughout the delay time. If you need to open the door, you must first set the washing machine to Pause by pressing the “**Start/Pause**” button. The door locked light goes off. After you have closed the door, press the “**Start/Pause**” button again.

## 12 Programme phase indicator lights

When you select a programme, the lights relevant to the phases that form the programme light up.

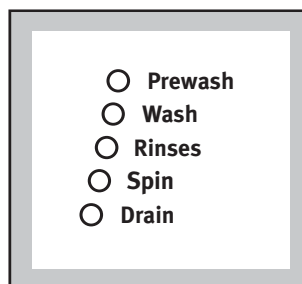

After you have started the programme, only the light relevant to the phase that is currently being carried out will remain lit.

# Operating Sequence

Before the first wash, we recommend that you run a cotton cycle at 95°C, without any laundry in the machine, to remove any manufacturing residue from the drum and tub.

Pour 1/2 a measure of detergent into the main wash compartment  of the dispenser drawer and start the machine.

## WASHING 5 KG OF WHITE COTTON AT 95°C

Suppose you have 5 kg of laundry to wash. It is white cotton and is suitable for high temperature washing.

### 1. Load the laundry

Open the door.

Place the laundry in the drum, one item at a time, shaking them out as much as possible.

Close the door.

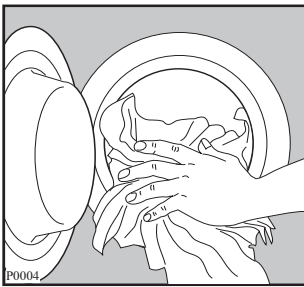

### 2. Measure out the detergent

Pull out the dispenser drawer until it stops. Measure out the amount of detergent required and pour it into the main wash compartment .

If you wish to carry out the prewash, pour detergent into the appropriate compartment marked .

### 3. Measure out the fabric softener

If required, pour fabric softener into the compartment marked , **without exceeding the «MAX» mark.**

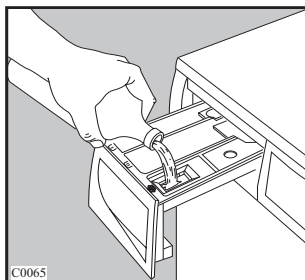
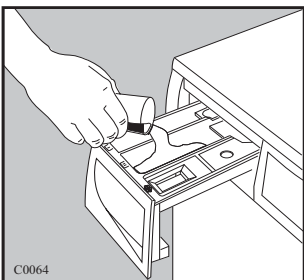

Close the drawer gently.

### 4. Switch the machine on

Press the “On/Off” button to switch the machine on. The display will show three flashing dashes or a flashing zero. The light above the button will light up.

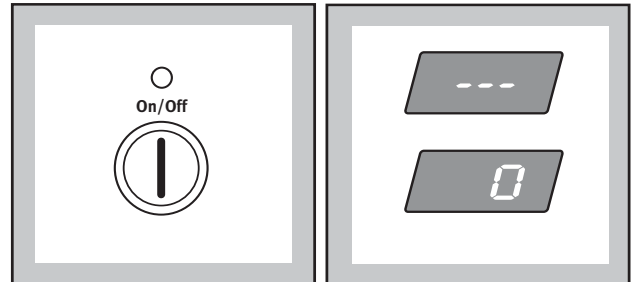

### 5. Select the desired programme/fabric

Press the FABRICS button repeatedly, in order to select the desired programme/fabric (**Cottons** or **Cotton Daily**). The relevant light will light up.

The lights relevant to the phases that form the programme will light up.

The display will show the duration of the selected programme, calculated on the basis of the maximum load for each type of fabric. The “Start/Pause” button light will start flashing.

If the load of laundry to be washed is small, at the beginning of the cycle the display will still indicate the duration relevant to the maximum load. The duration value will be gradually adjusted during the cycle.

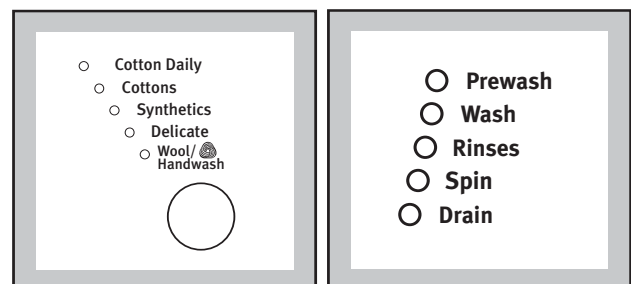

### 6. Select the temperature

Press the “Temp.” button if you wish to select a temperature value different from the one proposed by the washing machine (select 95°C).

The relevant light will light up.

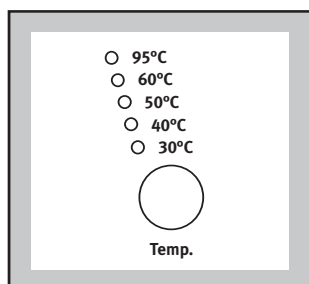

## 7. Select the spin speed or the Rinse Hold option

Press the “**Spin**” button repeatedly, in order to select the desired spin speed or the Rinse Hold option. The relevant light will light up.

If you select the **Rinse Hold** option, the machine will stop at the end of the programme with the water still in the tub.

**ZWF 1237 W**

**ZWF 1437 W**

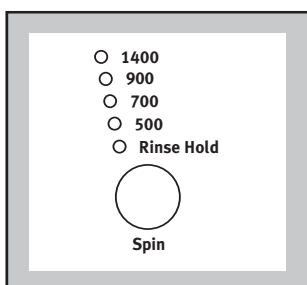
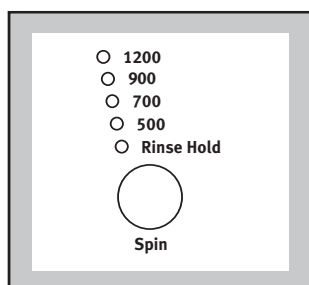

## 8. Select the desired options

If your laundry is heavily soiled, it may be advisable to select the “**Prewash**” option.

If is heavily soiled and you wish to prolong the washing time, select the “**Intensive**” option.

If your laundry is only slightly soiled, select the “**Extra Quick**” option.

The relevant light illuminates.

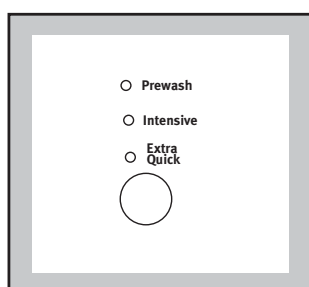

## 9. Select the Super Rinse or 40° AA option

If you wish the laundry to undergo an extra rinse, select the “**Super Rinse**” option.

If your laundry is lightly or normally soiled and it is necessary to prolong the washing time, select the “**40° AA**” option.

The relevant light illuminates.

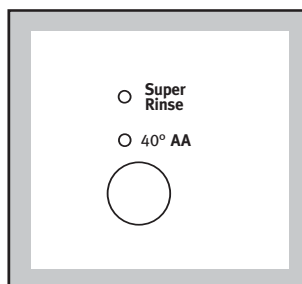

## 10. Select the “Delay”

**Before you start the programme**, if you wish the start to be delayed, press the “**Delay**” button repeatedly, or keep it pressed, to select the desired delay. The selected delay time value (up to 23 hours) will appear on the display for 3 seconds, then the duration of the programme will appear again.

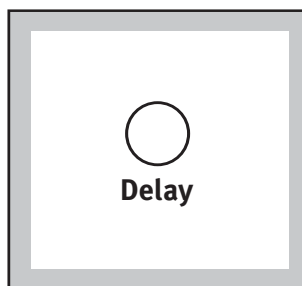

## 11. Start the programme

Press the “**Start/Pause**” button. The relevant light will stop flashing and only the light relevant to the phase that is in progress will remain lit.

If you have chosen a delayed start, the washing machine will begin the countdown.

The display will show the duration of the programme or the selected delay.

## 12. How to change an option or a programme during its cycle

Before you make any change, you must pause the machine by pressing the “**Start/Pause**” button.

It is possible to change the temperature or any option before the programme carries it out.

Changing a running programme is possible only by cancelling it and selecting a new programme.

The machine will resume the cycle **from the beginning** and the washing water in the tub will not emptied out.

If it is necessary to drain the water, proceed as follows:

- PAUSE the machine by pressing the “**Start/Pause**” button;
- press the “**Skip/Reset**” button repeatedly, until only the “**Drain**” light remains lit;
- press the “**Start/Pause**” button again.

When the water has been drained, the display shows a blinking zero. You may now select a new programme and press the “**Start/Pause**” button to start it.

## 13. How to cancel a programme during its cycle

To cancel a programme that is being carried out, first pause the washing machine by pressing the “**Start/Pause**” button, then press the “**Skip/Reset**” button repeatedly, until the display shows **three flashing dashes**.

## 14. How to open the door during the cycle of a programme

You can open the door, after having set the washing machine to Pause, provided the following conditions exist:

- the washing machine is not in the heating phase beyond 55°C;
- the level of the water is not high;
- the drum is not turning.

If these requirements are met, when you pause the washing machine, the door locked light goes off and the door can be opened.

Should it not be possible to open the door, and should it be absolutely necessary to do so, switch the machine off by pressing the “**On/Off**” button.

After approximately 3 minutes, you can open the door.

**Pay attention to the level and temperature of the water in the washing machine!**

When you close the door and press the “**On/Off**” button again, the washing machine will resume the programme from the point where it had been interrupted.

## 15. End of programme

At the end of the programme, the washing machine stops automatically, gives an audible signal, the “**Start/Pause**” button light goes off, and the display shows a blinking zero.

If you have selected the “**Rinse Hold**” option, the door is locked (the door locked light is on), the **Start/Pause** button light goes off, the pilot light of **Rinse Hold** remains lit to indicate that the water must be drained. The display shows a flashing zero.

When the programme has been completed, a blinking zero appears on the display and the audible signal is given. The door locked light goes off.

**Press the Skip Reset button repeatedly to erase the programme that has just been carried out. If you omit to do this, the next time you switch the washing machine on, the flashing zero will appear on the display and you will hear the audible signal.**

**Note:** when you switch the machine on, if you must erase the previously performed programme, it is also sufficient to press the FABRIC button and select a new programme.

Press the “**On/Off**” button to switch the machine off. The relevant light will go out.

Remove the laundry from the washing machine.

Check whether the drum is completely empty, by rotating it with your hand. The purpose of this is to prevent any items of laundry from remaining accidentally in the drum, where they might get damaged in a subsequent wash (e.g. by shrinking) or bleed colour into another load of laundry.

We advise you to close the water supply tap and disconnect the plug from the socket.

Leave the door ajar in order to air the washing machine.

# Washing Hints

Do **NOT** overload the machine. Weigh the laundry the first few times you use the appliance.

The average weights of the most common items are listed below as a guide:

**1000g = 1 kg**

Sheet	700-1000 g
Pillow case	100-200 g
Tablecloth	400-500 g
Serviette	50-100 g
Tea towel	70-120 g
Linen hand towel	100-150 g
Towelling hand towel	150-250 g
Towelling bath towel	700-1000 g
Bath robe	1000-1500 g
Man's shirt	200-300 g
Apron	150-200 g

- Load the laundry loosely alternating large items with small ones.
- Sort the laundry according to the type of fabric, colour-fastness and how dirty it is.
- Avoid washing unhemmed or torn items as they may unravel.
- Before washing, empty all pockets of small objects which may have been left inside (coins, keys, screws etc). as these could damage the drain pump.
- When washing curtains, remove the hooks.
- Close poppers and zips and fasten loose buttons.
- It is essential to wash new coloured items separately when washing for the first time.
- When washing fabrics requiring different wash temperatures together, always select the lowest temperature.
- White items should not be washed with coloured items.
- Very small items (handkerchiefs, ribbons, socks etc) should be washed in a washing bag or a pillow case.
- Use a good quality detergent suitable for automatic washing machines.
- Use the correct quantities of detergent.
- For wool, use gentle detergent only in small quantities.
- Bleach is very corrosive; it should be used with care and kept out of reach of children.
- Some stains such as fruit, wine, grass, rust etc. are difficult to remove and should be treated before washing with specific products, which can be found in most household shops. In some cases it may help to soak the stain before washing with a special pre-soak product or biological detergent.
- Only wool marked "Pure New Wool - washable, preshrunk" can be washed in the the wool programme; other types of wool should be washed in Hand Wash programme..
- If you have used the machine to wash, rinse or spin only non-colour fast garments, there may be dye left in the sump. To ensure any subsequent wash is not contaminated with the dye, select and carry out a rinse and spin programme, without any garments, to ensure that any dye is removed from the sump.
- Once you have finished using the machine, you are advised to unplug it and turn off the water tap.

## Which detergent?....

To ensure you obtain the best wash results from your appliance, it is important to use the right detergent in your everyday wash, and only detergents recommended for use in automatic machines.

To maintain the appearance of your clothes and household textiles and to make them last longer you should use different types of detergent for different washes, whether for whites, colours or delicates.

### WHITES

We recommend the Ariel product range which is biological and designed to provide excellent cleaning and stain removal even at low temperatures.



### NON BIOLOGICAL

If you prefer to use a non biological detergent, which does not contain enzymes we recommend Fairy. Fairy provides good cleaning and stain removal.



### COLOURED

For coloured items you should use a detergent which is designed to clean while maintaining the original colour. Ariel Color does not contain bleach and therefore helps to preserve colours.



### DELICATE ITEMS

When washing delicates such as woollens, you should use a product which is specially designed to care for fine fabrics.

Dreft Automatic is suitable for woollens and other delicates.



### LAUNDRY BLEACH

For additional stain removal you may wish to use a product such as Ace Gentle Bleach which is used in addition to your chosen detergent. Ace is suitable for all washable fabrics including silks, woollens and coloureds.



## And in which form?

Not only are there different types of detergent, but they are also available in different forms. Whether you chose a powder or liquid in traditional or compact form is your own personal choice.

### TRADITIONAL POWDERS

Pour the powder directly into the dispenser drawer. Do not sprinkle powder onto clothes in the machine drum.

### TRADITIONAL LIQUIDS

Liquid can be placed in the main wash compartment of the detergent drawer marked with the symbol , start the machine immediately upon placing the detergent in the dispenser drawer.

Alternatively the detergent is measured into the specially designed dosing device\* which should be placed on top of the laundry, and at the back of the machine drum.

### COMPACT POWDERS AND LIQUIDS

Compact detergents (or concentrates as they are also known) are available in liquid or powder form, and generally require a smaller dosage. Follow the manufacturer's instructions to ensure the most economical usage. Pour the detergent directly into the dispenser drawer, or alternatively measure the detergent into the specially designed dosing device\* which should be placed on top of the laundry, and at the back of the machine drum.

\* **If you use a dosing device in a washer dryer, please ensure the dosing device/ball is removed before carrying out a drying programme.**

### FABRIC CONDITIONERS

These are ideal for improving 'softness', and also reduce static cling on synthetics and make ironing easier. They are available in two types:

For example Lenor liquid fabric softener, for use in the **washing machine/washer dryer**. The liquid fabric softener should be poured into the compartment marked with the symbol . Follow the manufacturer's dosage instructions and never exceed the MAX level.

















Bounce conditioning sheets for use in a **tumble dryer**. We recommend the conditioning sheets are pinned (using a safety pin) to an article of laundry and placed in the tumble dryer.





# Wash Care Symbols

Wash care labels inside garments recommend how to launder your clothes with the best results. The care labelling code is in line with care labelling used in the rest of Europe. The symbols used make it easy to select the correct programme on your washing machine.

WASHING SYMBOL	WASH ACTION	FABRIC
	Normal (Maximum)	White Cotton or Linen without Special Finishes
	Normal (Maximum)	Cotton, Linen or Viscose without Special Finishes Colourfast at 60°C.
	Reduced (Medium)	Nylon, Polyester/Cotton, Viscose with Special Finishes, Cotton/Acrylic Mix.
	Normal (Maximum)	Cotton, Linen or Viscose Colourfast at 40°C but not 60°C.
	Reduced (Medium)	Acrylics, Acetate, Triacetate, Wool mixes, Polyester/wool blends.
	Much Reduced (Minimum)	Wool, wool mixtures, Silks
	Hand wash only	Do not machine wash
<b>BLEACHING</b>		
	Chlorine bleach may be used	
<b>IRONING</b>		
	Hot iron	Cotton, Linen, Viscose
	Warm iron	Polyester mixtures, Wool
	Cool iron	Acrylic, Nylon, Polyester
<b>DRY CLEANING</b>		
	May be dry cleaned. Other letters and/or a bar beneath the circle will indicate the required process to the dry cleaner.	
<b>TUMBLE DRYING</b>		
	with high heat setting	
	with low heat setting	
	May be tumble dried	
<b>X</b>	A cross through any symbol means «DO NOT»	









## Important Notes

For best results, always use the dispenser drawer for dispensing detergents and liquid additives. Once the dispenser has been filled, close it by pushing it in gently. This is particularly important if you are using

fabric conditioner to avoid the conditioner entering the machine prematurely.

When using liquid detergent and a prewash programme, place the detergent into the correct compartment in the dispenser drawer, after the prewash has finished.

# Washing programmes

Type of laundry and symbols on labels	Load	Programme/temperature	Description of programme	Available options	Consumption*		
					Energy kWh	Water litres	Time h/min.
 <b>White cotton:</b> e.g. sheets, tablecloths, household linen	6 kg	<b>Cotton daily</b> 60° - 95°C	Main wash at 60° - 95°C 3 rinses Long spin	Spin / Rinse Hold Prewash Super Rinse	2.0	52	2.09
 <b>White cotton:</b> e.g. sheets, tablecloths, household linen	6 kg	<b>Cottons</b> 60° - 95°C	Main wash at 60° - 95°C 3 rinses Long spin	Spin / Rinse Hold Prewash Intensive Extra Quick Super Rinse 40° AA	2.05	52	2.19
 <b>Coloured cotton</b> *** : e.g. shirts, blouses, towels, underwear, household linen	6 kg	<b>Cottons</b> 60° - 50° - 40° - 30°C	Main wash at 60° - 50° - 40° - 30°C 3 rinses Long spin	Spin / Rinse Hold Prewash Intensive Extra Quick Super Rinse 40° AA**	1.2	49	1.58
 <b>Coloured cotton:</b> e.g. shirts, blouses, towels, underwear,	6 kg	<b>Cotton daily</b> 60° - 50° - 40° - 30°C	Main wash at 60° - 50° - 40° - 30°C 3 rinses Long spin	Spin / Rinse Hold Prewash Super Rinse	1.1	49	1.40
 <b>Synthetic fabrics and blends:</b> e.g. shirts, blouses, underwear	3 kg	<b>Synthetics</b> 60° - 50° - 40° - 30°C	Main wash at 60° - 50° - 40° - 30°C 3 rinses Short spin	Spin / Rinse Hold Prewash Intensive Extra Quick Super Rinse 40° AA **	1.05	55	1.27
 <b>Delicate fabrics:</b> e.g. acrylic fabrics, viscose, polyester, synthetic blends	3 kg	<b>Delicates</b> 40° - 30°C	Main wash at 40° - 30°C 3 rinses Short spin	Spin / Rinse Hold Prewash Extra Quick Super Rinse	0.6	57	58
  <b>Wool /</b>  <b>Handwash</b>	2 kg	<b>Wool/Handwash</b> 40° - 30°C	Main wash at 40° - 30°C 3 rinses Short spin	Spin / Rinse Hold	0.4	55	57

\* This data is given purely as an indication: the consumption values may vary in relation to the quantity and type of laundry, the temperature of the water supply and the ambient temperature. The data refers to the highest temperature provided for each programme.

\*\* Only at the temperature of 40°C or higher.

\*\*\* The “**Cottons programme**” at 60°C with the option **40° AA** selected is the reference programme for the data entered in the energy label, in compliance with EEC 92/75”:

**Load: 7 kg, Energy: 1.19 kWh, Water: 57 litres, Time: 155 mins.**

# Maintenance and Cleaning

Before any maintenance or cleaning is carried out you must **DISCONNECT** the appliance from the electricity supply.

## Descaling

The water we use normally contains lime. It is a good idea to periodically use a water softening powder in the machine. Do this separately from any laundry washing, and according to the softening powder manufacturer's instructions. This will help to prevent the formation of lime deposits.

## After each wash

Leave the door open for a while. This helps to prevent mould and stagnant smells forming inside the appliance. Keeping the door open after a wash will also help to preserve the door seal.

## Maintenance Wash

With the use of low temperature washes it is possible to get a build up of residues inside the drum. We recommend that a maintenance wash be performed on a regular basis.

### To run a maintenance wash:

- The drum should be empty of laundry.
- Select the hottest cotton wash programme.
- Use a normal measure of detergent, must be a powder (such as Ariel Futur).

## External cleaning

Clean the exterior cabinet of the appliance with soap and water only, and then dry thoroughly.

## Cleaning the dispenser drawer

The washing powder and additive dispenser drawer should be cleaned regularly.

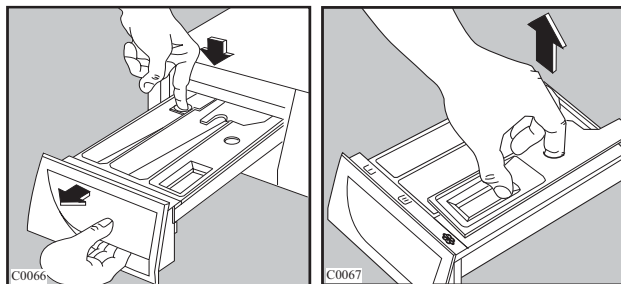

Remove the drawer by pressing the catch downwards and by pulling it out.

Flush it out under a tap, to remove any traces of accumulated powder.

To aid cleaning, the top part of the additive compartment should be removed.

## Cleaning the drawer recess

Having removed the drawer, use a small brush to clean the recess, ensuring that all washing powder residue is removed from the upper and lower part of the recess.

Replace the drawer and run the rinse programme without any clothes in the drum.

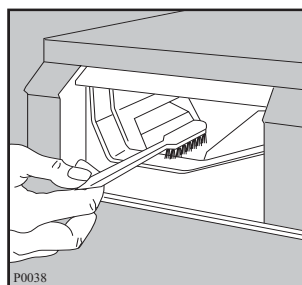

## Cleaning the pump

The pump should be inspected if

- the machine does not empty and/or spin
- the machine makes an unusual noise during draining due to objects such as safety pins, coins etc. blocking the pump.

Proceed as follows:

- Disconnect the appliance.
- If necessary wait until the water has cooled down.
- Open the pump door.

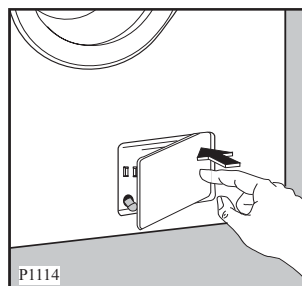

- Place a container close to the pump to collect any spillage.
- Pull out the emergency emptying hose, place it in the container and remove its cap.

- When no more water comes out, unscrew the pump cover and remove it. Always keep a rag nearby to dry up spillage of water when removing the cover.

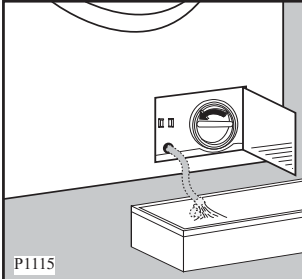

- Remove any objects from the pump impeller by rotating it.

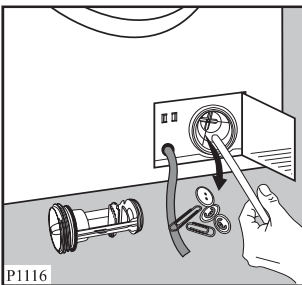

- Put the cap back on the emergency emptying hose and place the latter back in its seat.



- Screw the pump cover fully in.
- Close the pump door.

### **Warning**

When the appliance is in use and depending on the programme selected there can be hot water in the pump. Never remove the pump cover during a wash cycle, always wait until the appliance has finished the cycle, and is empty. When replacing the cover, ensure it is securely retightened so as to stop leaks and young children being able to remove it.

## Cleaning the water inlet filter

If your water is very hard or contains traces of lime deposit, the water inlet filter may become clogged.

It is therefore a good idea to clean it from time to time. Turn off the water tap. Unscrew the water inlet hose. Clean the filter using a hard bristle brush. Tighten up the inlet hose.

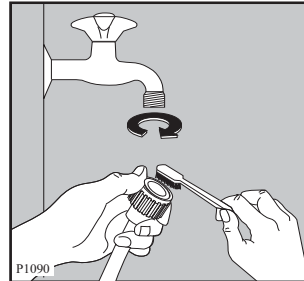

## The dangers of freezing

If the machine is exposed to temperatures below 0°C, certain precautions should be taken.

- Turn off the water tap.
- Unscrew the inlet hose.
- Place the end of the emergency emptying hose and that of the inlet hose in a bowl placed on the floor and let water drain out.
- Screw the water inlet hose back on and reposition the emergency emptying hose after having put the cap on again.
- When you intend to start the machine up again, make sure that the room temperature is above 0°C.

## Emergency emptying out

If the water is not discharged, proceed as follows to empty out the machine:

- pull out the plug from the power socket;
- close the water tap;
- if necessary, wait until the water has cooled down;
- open the pump door;
- place a bowl on the floor and place the end of the emergency emptying hose into the bowl. Remove its cap. The water should drain by gravity into the bowl. When the bowl is full, put the cap back on the hose. Empty the bowl. Repeat the procedure until water stops flowing out;
- clean the pump if necessary as previously described;
- replace the emergency emptying hose in its seat after having plugged it;
- screw the pump cover again and close the door.

# Something Not Working

Certain problems are due to lack of simple maintenance or oversights, which can be solved easily without calling out an engineer. Before contacting your local Service Force Centre, please carry out the checks listed below.

**IMPORTANT: if you call out an engineer to a fault listed below, or to repair a fault caused by incorrect use or installation, a charge will be made even if the appliance is under guarantee.**

During machine operation it is possible that one of the following alarm codes appears on the display and at the same time the buzzer sounds:

- **E10** : problem with the water supply
- **E20** : problem with water draining
- **E40** : door open

Once the problem has been eliminated, press the “**Start/Pause**” button to restart the programme. If after all checks, the problem persists, contact your local Service Force Centre.

Symptom	Possible causes
<b>The machine does not start</b>	<ul style="list-style-type: none"> <li>● The door has not been closed. (<b>E40</b>)</li> <li>● The plug is not properly inserted in the power socket.</li> <li>● There is no supply at the socket.</li> <li>● The main fuse or the fuse in the plug has blown.</li> <li>● The Start/Pause button has not been depressed.</li> <li>● The “Delay” option has been selected.</li> </ul>
<b>The machine does not fill</b>	<ul style="list-style-type: none"> <li>● The water tap is closed. (<b>E10</b>)</li> <li>● The filter in the inlet hose is blocked. (<b>E10</b>)</li> <li>● The inlet hose may be squashed or kinked. (<b>E10</b>)</li> <li>● The door has not been closed. (<b>E40</b>)</li> </ul>
<b>The machine fills then empties immediately</b>	<ul style="list-style-type: none"> <li>● The end of the drain hose is too low.</li> <li>● The end of the drain hose is submerged in water.</li> <li>● There is no vent in the end of the drain hose.</li> </ul>
<b>The machine does not empty and/or does not spin</b>	<ul style="list-style-type: none"> <li>● The drain hose may be squashed or kinked. (<b>E20</b>)</li> <li>● The Rinse Hold option has been selected.</li> <li>● The drain pump may be blocked. (<b>E20</b>)</li> <li>● The drain hose extension, if fitted, is not correct. Follow the instructions for connecting to the waste.</li> <li>● The drainage system pipes are blocked.</li> <li>● The wash load is unbalanced: redistribute the clothes inside the drum to allow the machine to spin.</li> </ul>
<b>There is water on the floor</b>	<ul style="list-style-type: none"> <li>● Too much detergent or unsuitable detergent has been used (creates too much foam).</li> <li>● Check whether there are any leaks from the inlet hose fittings. It is not always easy to see this as the water runs down the hose; check to see if it is damp.</li> <li>● The drain hose may be damaged or not securely positioned.</li> <li>● The detergent dispenser drawer or recess is clogged.</li> <li>● The drainage system pipes are blocked.</li> <li>● The cap on the emergency emptying hose has not been replaced or not fully screwed up after cleaning the pump.</li> </ul>
<b>The door will not open</b>	<ul style="list-style-type: none"> <li>● The water level is above the bottom edge of the door.</li> <li>● The machine is heating the water.</li> <li>● The drum is turning.</li> </ul> <p><b>The door can be opened only when the relevant light has gone out.</b></p>

Symptom	Possible causes
<b>The machine vibrates when spinning</b>	<ul style="list-style-type: none"> <li>• The internal packing has not been removed.</li> <li>• The machine is in contact with the wall or furniture.</li> <li>• The machine is not level and stable (check diagonally).</li> <li>• The washing load is badly distributed in the drum.</li> <li>• Maybe there is very little laundry in the drum.</li> </ul>
<b>Spinning starts late or the machine does not spin</b>	<ul style="list-style-type: none"> <li>• The electronic unbalance detection device has cut in because the laundry is not evenly distributed in the drum. The laundry is redistributed by reverse rotation of the drum. This may happen several times before the unbalance disappears and normal spinning can resume. If, after 6 minutes, the laundry is still not evenly distributed in the drum, the machine will not spin. In this case, redistribute the load manually and select the spin programme.</li> </ul>
<b>The machine makes an unusual noise</b>	<ul style="list-style-type: none"> <li>• The machine is fitted with a type of motor which makes an unusual noise compared with other traditional motors. This new motor ensures a softer start and more even distribution of the laundry in the drum when spinning, as well as increased stability of the machine.</li> </ul>
<b>No water is visible in the drum</b>	<ul style="list-style-type: none"> <li>• Machines based on modern technology operate very economically using very little water without affecting performance.</li> </ul>
<b>Unsatisfactory washing results</b>	<ul style="list-style-type: none"> <li>• Too little detergent or unsuitable detergent has been used. An insufficient amount of detergent leaves the laundry looking grey and causes lime scale to form.</li> <li>• Stubborn stains have not been treated prior to washing</li> <li>• The correct wash programme/temperature has not been selected.</li> <li>• Too much laundry has been placed in the drum.</li> </ul>

## Service & Spare Parts **SERVICE FORCE**

In the event of your appliance requiring service, or if you wish to purchase spare parts, please contact your local Service Force Centre by telephoning:

**0870 5 929929**

Your telephone call will be automatically routed to the Service Force Centre covering your post code area.

For the address of your local Service Force Centre and further information about Service Force, please visit the website at [www.serviceforce.co.uk](http://www.serviceforce.co.uk).

For Customer Service in Ireland please contact us at the address below:

Zanussi Electrolux - Electrolux Group (Irl) Ltd  
 Long Mile Road  
 Dublin 12  
 Republic of Ireland  
 Tel: +353 (0)1 4090751  
 Email: [service.eid@electrolux.ie](mailto:service.eid@electrolux.ie)

**To buy accessories, consumables and spare parts at our online shop please visit: <http://www.zanussi-electrolux.co.uk>**

Before calling out an engineer, please ensure you have read the details under the heading “Something Not Working”.

When you contact the Service Force Centre you will need to give the following details:

1. Your name, address and post code
2. Your telephone number
3. Clear and concise details of fault
4. The model and serial number of the appliance (found on the rating plate - see picture)
5. The purchase date.

**Please note that a valid purchase receipt or guarantee documentation is required for in-guarantee service calls.**

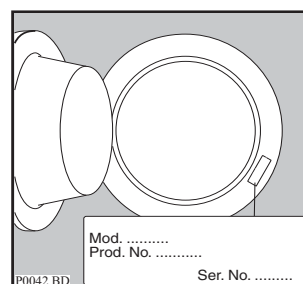

## Customer Care

For general enquiries concerning your Zanussi Electrolux appliance or for further information on Zanussi Electrolux products, please contact our Customer Care Department by letter or telephone at the address below or visit our website at [www.zanussi.co.uk](http://www.zanussi.co.uk):

Customer Care Department - Zanussi/Electrolux

### Major Appliances

Addington Way, Luton  
Bedfordshire  
LU4 9QQ  
Tel 08705 727 727\*

\* calls to this number may be recorded for training purposes.

# Guarantee Conditions

## Standard guarantee conditions

We, Zanussi Electrolux, undertake that if, within 12 months of the date of the purchase, this ZANUSSI ELECTROLUX appliance or any part thereof is proved to be defective by reason only of faulty workmanship or materials, we will, at our option repair or replace the same FREE OF ANY CHARGE for labour, materials or carriage on condition that:

- The appliance has been correctly installed and used only on the electricity supply stated on the rating plate.
- The appliance has been used for normal domestic purposes only, and in accordance with the manufacturer's instructions.
- The appliance has not been serviced, maintained, repaired, taken apart or tampered with, by any person not authorised by us.
- All service work under this guarantee must be undertaken by a Service Force Centre.
- Any appliance or defective part replaced shall become the Company's property.
- This guarantee is in addition to your statutory and other legal rights.

Home visits are made between **8.30am** and **5.30pm** Monday to Friday. Visits may be available outside these hours in which case a **premium** will be charged.

## Exclusions

### This guarantee does not cover:

- Damage or calls resulting from transportation, improper use or neglect, the replacement of any light bulbs or removable parts of glass or plastic.
- Costs incurred for calls to put right an appliance which is improperly installed or calls to appliances outside the United Kingdom.

- Appliances found to be in use within a commercial environment, plus those which are subject to rental agreements.
- Products of Zanussi Electrolux manufacture which are NOT marketed by Zanussi Electrolux.

## European guarantee

If you should move to another country within Europe then your guarantee moves with you to your new home subject to the following qualifications:





- The guarantee starts from the date you first purchased your product.
- The guarantee is for the same period and to the same extent for labour and parts as exists in the new country of use for this brand or range of products.
- The guarantee relates to you and cannot be transferred to another user.
- Your new home is within the European Community (EC) or European Free Trade Area.
- The product is installed and used in accordance with our instructions and is only used domestically, i.e. a normal household.
- The product is installed taking into account regulations in your new country.

Before you move please contact your nearest Customer Care Centre, listed below, to give them details of your new home. They will then ensure that the local Service Organisation is aware of your move and able to look after you and your appliances.

France	Senlis	+33 (0) 344 62 29 29
Germany	Nurnberg	+49 (0) 800 234 7378
Italy	Pordenone	+39 0434 39 4700
Sweden	Stockholm	+46 (0) 8 672 53 90
UK	Luton	+44 (0) 8705 727 727
Ireland	Dublin	+353 (0) 1 4090751



# Installation Instructions

-  It is dangerous to alter the specifications or attempt to modify this product in any way.
-  Care must be taken to ensure that the appliance does not stand on the electrical supply cable.
-  Any electrical work required to install this appliance should be carried out by a qualified electrician or competent person.
-  Any plumbing work required to install this appliance should be carried out by a qualified plumber or competent person.

# Technical Specifications

DIMENSIONS	Height Width Depth	85 cm 60 cm 63 cm
POWER SUPPLY VOLTAGE TOTAL POWER ABSORBED		230-240 V/50 Hz 2050 W (10A)
WATER PRESSURE	Minimum Maximum	0.05 MPa (0.5 bar) 0.8 MPa (8 bar)
MAXIMUM RECOMMENDED LOAD	Cotton, linen Synthetics Delicate fabrics Wool/Hand wash	7 kg 3 kg 3 kg 2 kg
SPIN SPEED	Maximum	1200 rpm (ZWF 1237 W) 1400 rpm (ZWF 1437 W)
CONSUMPTION DATA FOR WASHING 7 KG NORMALLY SOILED COTTON ITEMS AT 60°C + 40°AA option selected	Energy Water Time	1.19 kWh 57 litres 155 minutes

- CE** This appliance complies with the following E.E.C. Directives:
- 73/23 EEC of 19.2.73 (Low Voltage Directive) and subsequent modifications;
  - 89/336 EEC of 3.5.89 (Electromagnetic Compatibility Directive) and subsequent modifications.

## Unpacking

**!** All transit bolts and packing must be removed before using the appliance.

You are advised to keep all the packaging for re-use in case the machine is to be transported again.

Using a spanner unscrew and remove the two rear bottom screws. Slide out the two plastic pins.

Lay the machine gently on its back, making sure that the hoses are not squashed.

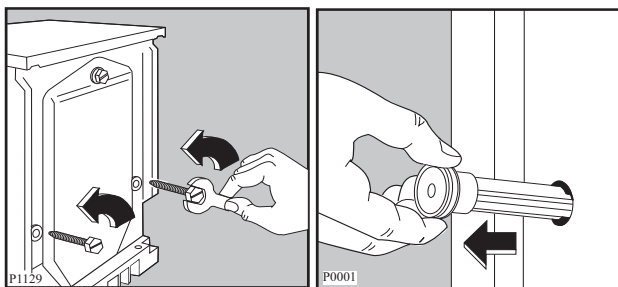

Remove the polystyrene block from the bottom of the machine and release the two plastic bags.

Very carefully slide out the left polythene bag, removing it towards the right and then downwards.

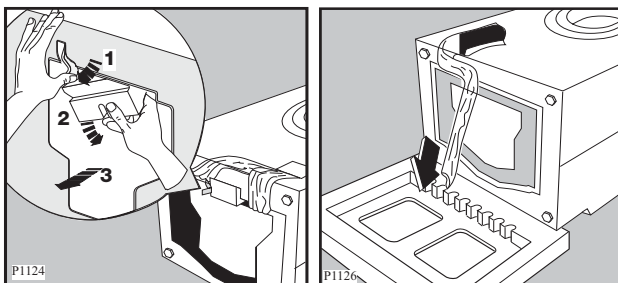

Repeat the operation for the right polythene bag, removing it towards the left and then upwards.

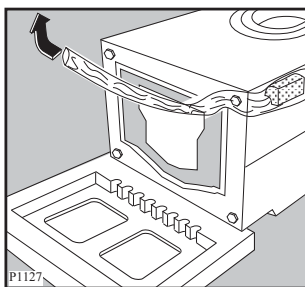

Remove the polystyrene base. Set the machine upright and unscrew the remaining rear screw. Slide out the relevant pin.

Fill all the holes with the plastic plugs supplied with the instruction booklet.

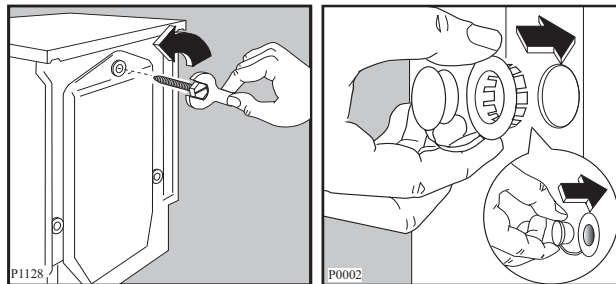

### Important !

**You are advised to keep all the packaging for re-use in case the machine is to be transported again.**

**In case of moving out the same precautions as per paragraph "The dangers of freezing" must be taken i.e. the residual water in the hoses must be pumped out.**

## Positioning

Install the machine on a flat hard floor.

Make sure that air circulation around the machine is not impeded by carpets, rugs etc. Check that the machine does not touch the wall or other kitchen units.

Never place cardboard, wood or similar materials under the machine to compensate for any unevenness in the floor.

Your new washing machine has been designed to be permanently plumbed in to your home's water supply and drainage system. However, if this is not possible, it may be connected to a suitable existing tap with the drain hose discharging into a sink.

The appliance has an inlet hose, with female 3/4" BSP thread connector. If this connection is not compatible with the plumbing of the existing installation, a variety of connectors are available from good hardware stores and plumbers merchants to suit most domestic plumbing. Any alteration to your existing plumbing must be carried out by a competent person, or qualified plumber.

## Installation on a Suspended Floor

Suspended wooden floors are particularly susceptible to vibration. To help prevent vibration we recommend you place a waterproof wood panel, at least 15 mm thick under the appliance, secured to at least 2 floor beams with screws. If possible install the appliance in one of the corners of the room, where the floor is more stable.

## Water inlet

Connect the hose to a tap with a 3/4" thread.

**Do not use already employed hoses.**

Always use the hose supplied with the appliance to connect to the water supply.

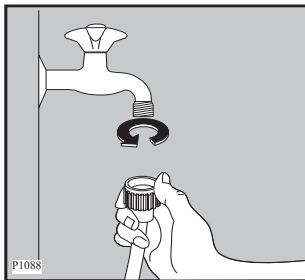

Installation should comply with local water authority and building regulations' requirements.

**The appliance must be connected to a cold water supply.**

A minimum water pressure of 0.05 MPa (0.5 bar) is required for safe operation of the appliance.

If you cannot make the cold water connection direct from the rising mains, you may be able to operate the appliance from your cold water storage system.

There should be a minimum distance of 5.02m (16.5 ft) between the appliance's inlet and the bottom of the water storage tank.

Set the hose correctly by loosening the ring nut. After positioning the inlet hose, be sure to tighten the ring nut again to prevent leaks.

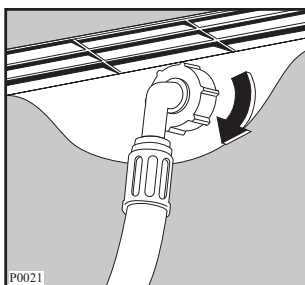

## Water drainage

This appliance is designed to be permanently plumbed into your home's drainage system using one of the following methods.

### 1. Into a drainage standpipe.

Firstly form a hook in the end of the drain hose using the "U" piece" supplied.

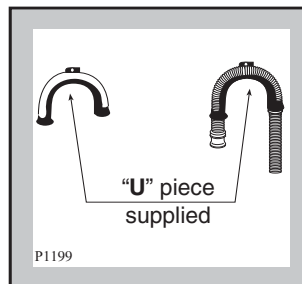

Place the drain hose into your standpipe, which should have an internal diameter of approximately 38mm thus ensuring there is an air break between the drain hose and standpipe.

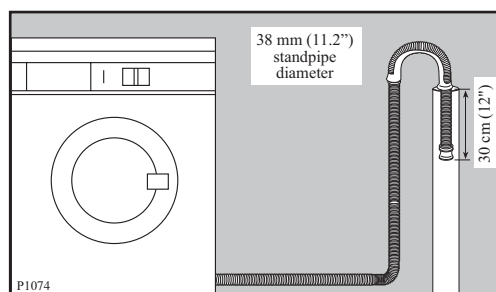

When discharging into a standpipe ensure that the top of the standpipe is no more than 90cm (35.4") and no less than 60cm (23.6") above floor level.

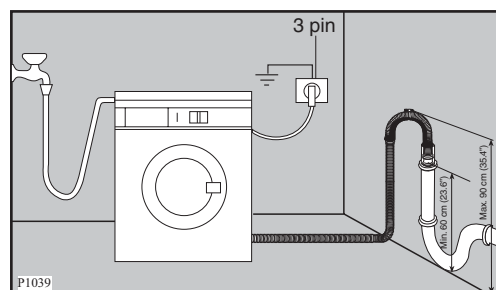

The drain hose may be extended to a maximum of 4 metres. An additional drain hose and joining piece is available from your local Service Force Centre. The joining piece must have an internal diameter of 18mm.

If your drain hose looks like this (see below) you do not require the "U" piece". Just push the hose firmly into the standpipe.

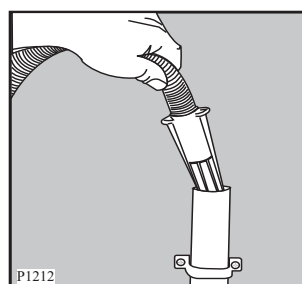

## 2. Onto a sink outlet spigot.

If the outlet spigot has not been used before, remove any blanking plug that may be in place.

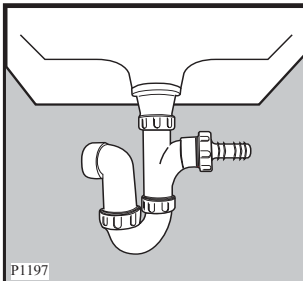

Push the drain hose onto the spigot and secure with a clip if required, ensure a loop is formed in the drain hose (see diagram) to prevent waste from the sink entering the washing machine.

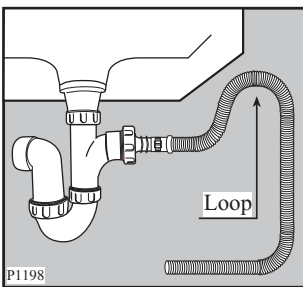

The drain hose may be extended to a maximum of 4 metres. An additional drain hose and joining piece is available from your local Service Force Centre. The joining piece must have an internal diameter of 18mm.

### Important

Before connecting the machine to new pipework or to pipework that has not been used for some time, run off a reasonable amount of water to flush out any debris that may have collected in the pipes.

### Levelling

Level the washing machine by raising or lowering the feet. The feet may be tight to adjust as they incorporate a self locking nut, but the machine **MUST** be level and stable (check diagonally).

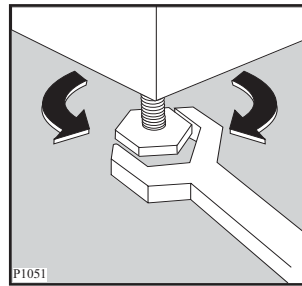

Any necessary adjustment can be made with a spanner. Accurate levelling prevents vibration, noise and displacement of the machine during operation.

Some vibration is inevitable, especially if mounted on a wooden floor.

Sprung wooden floors are particularly susceptible to vibration. For advice, consult a builder. If possible, always place the machine on a solid floor.

### Special conditions

If the floor is carpeted or covered with crumbly or soft material, insert a rigid support base under the feet to prevent noise, vibration or displacement. The base should protrude a few centimetres beyond the edges of the machine.



#### Warning

The machine should **NOT** be placed on deep pile carpeting.

#### Note

Please ensure that when the appliance is installed it is easily accessible for the engineer in the event of a breakdown.

### In the interest of the environment

Washing machines and dishwashers should be connected to the FOUL drainage system, the water will then be taken to a sewage works for treatment before being discharged safely into a river.

It is essential that these appliances are not connected to the surface water drainage system as this water is discharged directly into a river or stream and may cause pollution.

If you require any further advice please contact your local water authority.

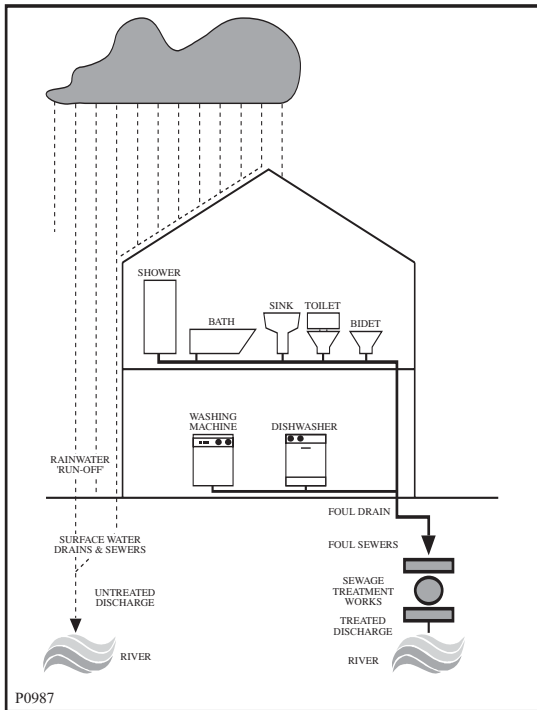

Should the plug need to be replaced for any reason, proceed as described below.

The wires in the mains lead are coloured in accordance with the following code:

- Green and Yellow - Earth
- Blue - Neutral
- Brown - Live

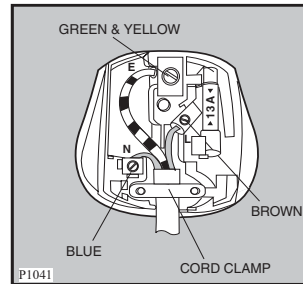

The wire coloured green and yellow must be connected to the terminal marked with the letter «E» or by the earth symbol  $\perp$  or coloured green and yellow.

The wire coloured blue must be connected to the terminal marked «N» or coloured black.

The wire coloured brown must be connected to the terminal marked «L» or coloured red.

Upon completion there must be no cut, or stray strands of wire present and the cord clamp must be secure over the outer sheath.

## Electrical connection

Any electrical work required to install this appliance should be carried out by a qualified electrician or competent person.



**WARNING: THIS APPLIANCE MUST BE EARTHED.**

**The manufacturer declines any liability should this safety measure not be observed.**

Before switching on, make sure the electricity supply voltage is the same as that indicated on the appliance's rating plate. The rating plate is located at the top of the rim of the open door.

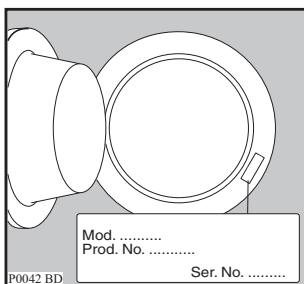

The appliance is supplied with a 13amp plug fitted. In the event of having to change the fuse in the plug supplied, a 13amp ASTA approved (BS1363/A) fuse must be used.

### WARNING:



**A cut off plug inserted into a 13 amp socket is a serious safety (shock) hazard. Ensure that the cut off plug is disposed of safely. Should the appliance power supply cable need to be replaced, this must be carried out by our Service Force Centre.**

### Note

When the appliance is installed the power supply cable must be accessible.

## Permanent connection

In the case of permanent connection it is necessary that you install a double pole switch between the appliance and the electricity supply (mains), with a minimum gap of 3mm between the switch contacts and of a type suitable for the required load in compliance with the current electrical regulations.

The switch must not break the yellow and green earth cable at any point.

 **From the Electrolux Group. The world's No. 1 choice.**

*The Electrolux Group is the world's largest producer of powered appliances for kitchen, cleaning and outdoor use. More than 55 million Electrolux Group products (such as refrigerators, cookers, washing machines, vacuum cleaners, chain saws and lawn mowers) are sold each year to a value of approx. USD 14 billion in more than 150 countries around the world.*

**This file has been downloaded from:**

[www.UsersManualGuide.com](http://www.UsersManualGuide.com)

User Manual and User Guide for many equipments like mobile phones, photo cameras, mother board, monitors, software, tv, dvd, and othes..

Manual users, user manuals, user guide manual, owners manual, instruction manual, manual owner, manual owner's, manual guide, manual operation, operating manual, user's manual, operating instructions, manual operators, manual operator, manual product, documentation manual, user maintenance, brochure, user reference, pdf manual